



Est. 1981

Quality Tractor Parts Ltd.

Zone C, Mullingar Business Park, Mullingar, Co. Westmeath, Ireland. Ph: + 353 44 934 1638 Email: info@qtponline.com Web: qtponline.com

ENGINE PARTS CATALOGUE

REPLACEMENT PARTS SUITABLE FOR

MASSEY FERGUSON, FORD NEW HOLLAND, JOHN DEERE RELAINCE, CASE IH, ZETOR, DAVID BROWN, FIAT, RENAULT, DEUTZ, LANDINI, LEYLAND, SAME, JBC, FENDT, VALMET



Contents

Massey Ferguson	003
Ford NewHolland	097
John Deere Reliance	150
Case	211
Fiat	226
David Brown	234
Zetor	245
Renault	253
Deutz	257
Landini	261
Leyland	262
Same	264
JCB	265
Massey Ferguson Diggers	266
Fendt	268
Valmet	269

Sealant & Gasket Paper

1861108



Silicone Sealer -
80ml

1861117



Gasket Sealer -
100g

1475



Silicone Sealer
300ml

1478



Gasket Sealer
350g

Plain

Sold Per Metre

3167 - 0.80 mm Paper
3168 - 1.00 mm Paper



Cork

Sold Per Metre

3171 - 3 mm Cork



20 TVO Gaskets

1039

Gasket Set 20 TVO
- Complete

1375

Head Gasket 20 TVO

1098

Head Gasket Set 20
TVO

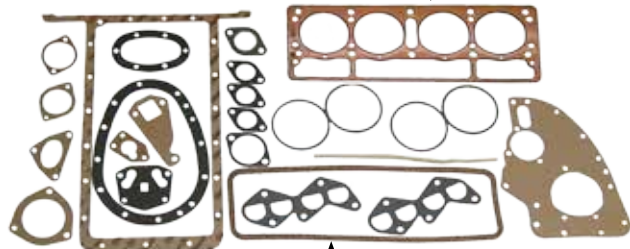

1097
Rocker Cover Gasket 20 TVO

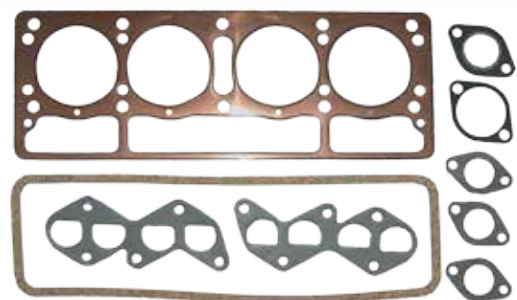

63288
Gasket Exhaust Manifold
20TVO (PAIR)

Gaskets

TEF20

1005
Gasket Set 20D
- Complete

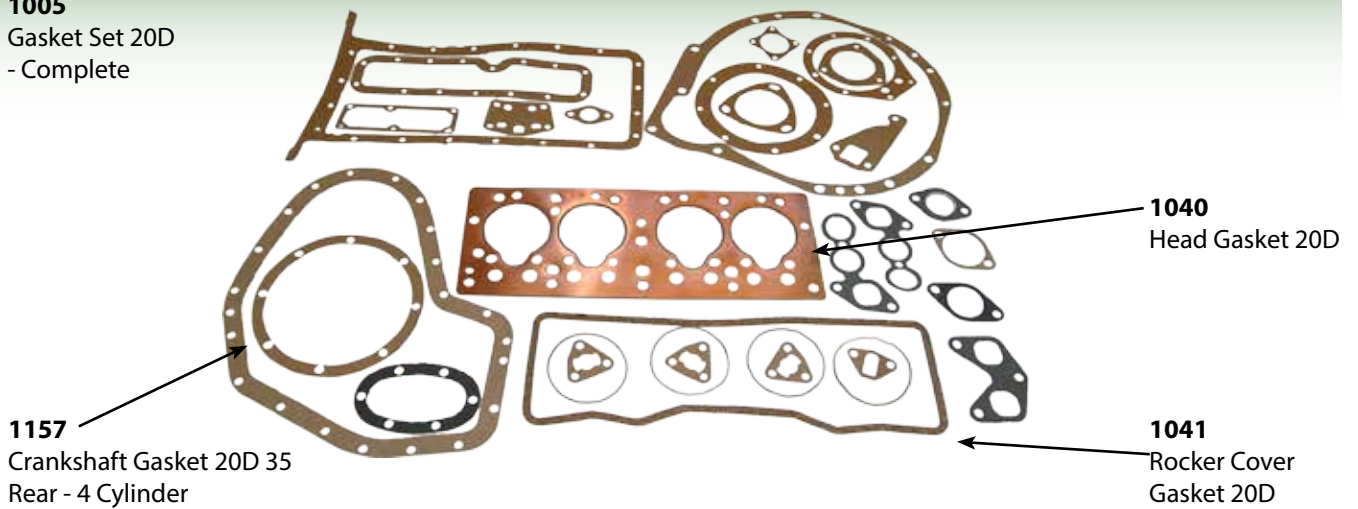

1122

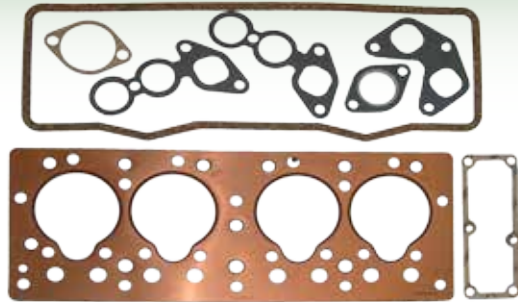

Head Gasket Set 20D

1033

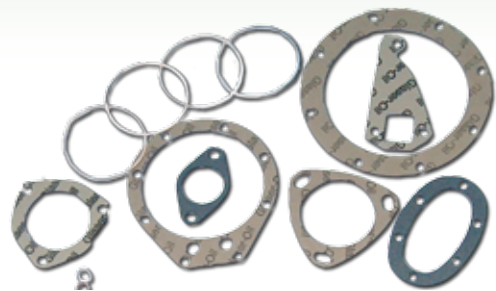

Sump Gasket Set 20D TEF

35 4 Cylinder

1004
Gasket Set 35 4 Cylinder Diesel - Complete
Fits 135 Petrol TEA20 TED20 Engine 23C

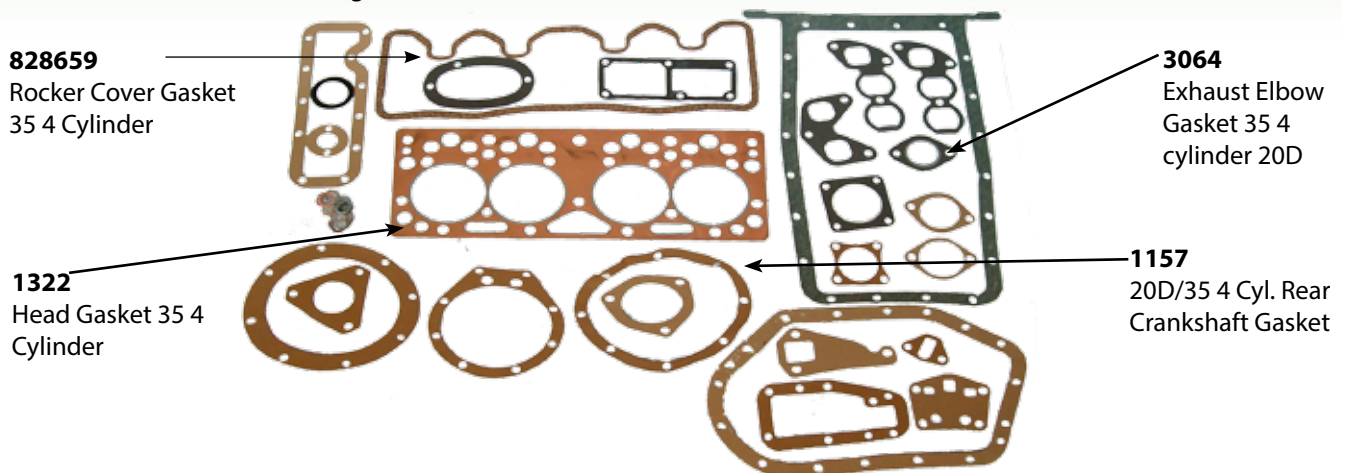

Gaskets

35 4 Cylinder

3563

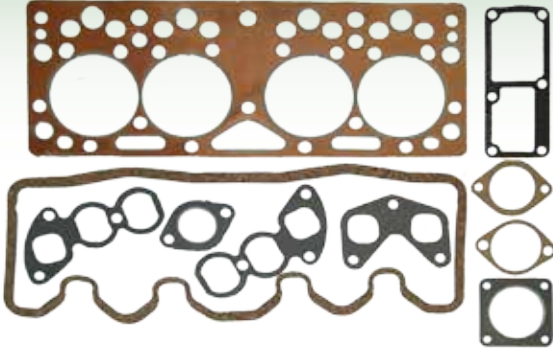

Head Gasket Set 35 4
Cylinder

3218

Exhaust Manifold
Gasket 20D - Single



3217

Exhaust Manifold Gasket
20D 35 4 Cylinder



3219

Exhaust Manifold
Gasket 35 4 Cylinder
Single



62700

Exhaust Manifold Gas-
ket 20D FE35 4 Cyl - SET



35/35x Head Set

U5LT0012

Head Gasket Set 35 35X
Copper

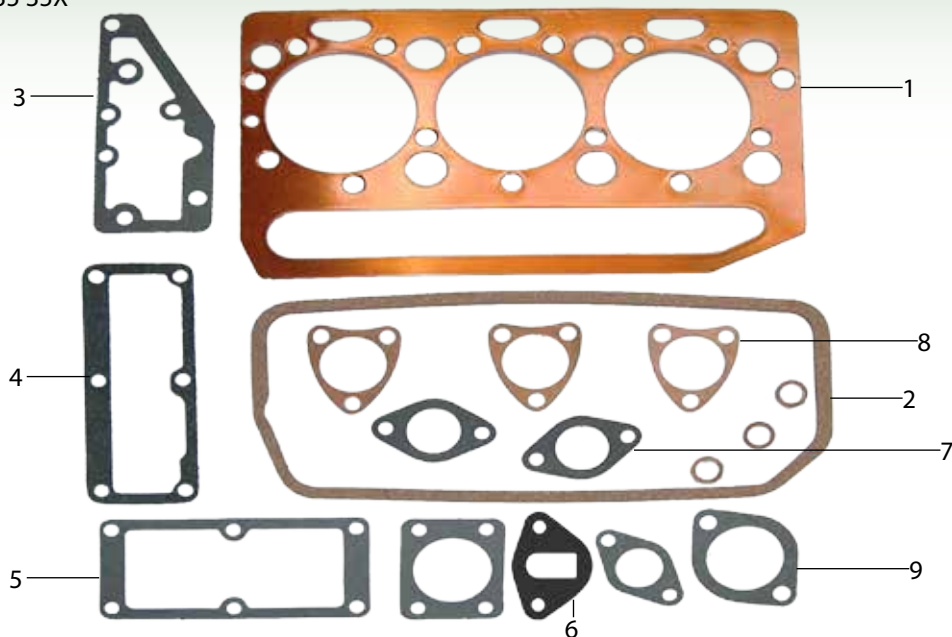

- 1 **36812136** Head Gasket 35 35X - 3152 x 35
- 2 **0490491** Rocker Cover Gasket 35 35X
- 3 **0490482** Thermostat Housing Gasket 35 135
- 4 **41218** Air Inlet Manifold Gasket 35 Dexta / Super De
- 5 **0490485** Back Plate Gasket 35 135 ** Pack of 2 **
- 6 **36862167** Fuel Lift Pump Gasket 35 PACK OF 2
- 7 **0490481** Exhaust Manifold Gasket 35X Dexta
- 8 **0490023** Combustion Cap Gasket 35
- 9 **049135** Thermostat Housing Gasket 35 135 Top ** Pack of 2 **

Gaskets

35 3 Cylinder

82887

Sump Gasket Set 135 35
- D3 152 Rope Seal

- 1 **049157** Timing Cover Gasket 35 135
- 2 **0490514** Oil Filter Head Gasket 135 148
- 3 **0490685** CAV Pump Injector Pump Gasket
- 4 **36817134** Crankshaft Gasket 152 Rear
- 5 **0490484** Water Pump Gasket 35 135
- 6 **36862167** Fuel Lift Pump
- 7 **33826111** Lip Seal Gasket 135 Rear
- 8 **36862511** Rev Counter Gasket 35 135
- 9 **61265** Timing Cover Gasket 135 Rear

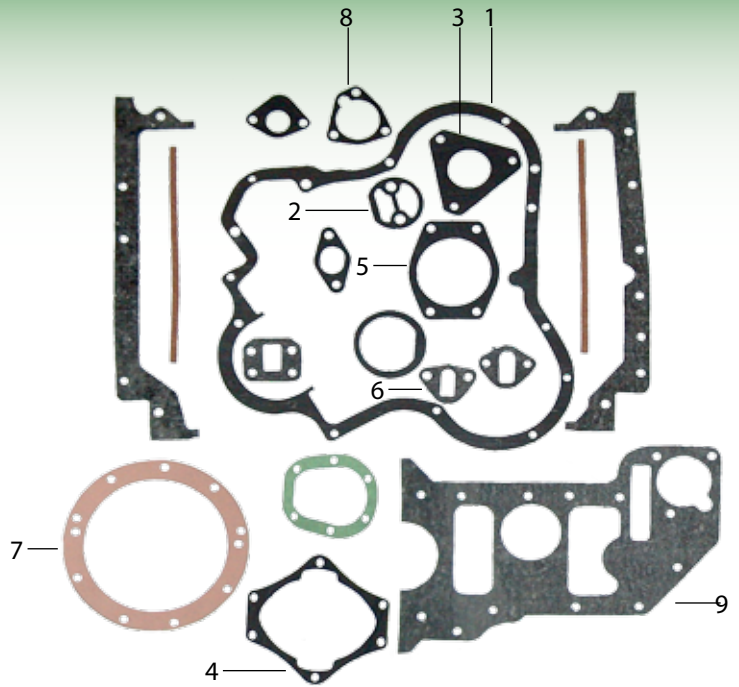

Mini Sump Set

53587

Sump Gasket Set 135 35 Mini



- 1. **0490019** Sump Packer 135 Short
- 2. **36884112** Sump Packer 135 - From Serial

3623H004

Water Pump Back Plate -
Stainless Steel

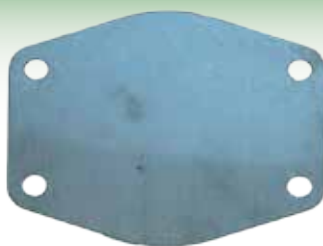

0490484

Water Pump Gasket
35 135

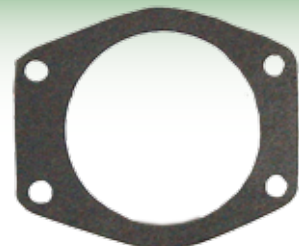

Gaskets

135/240 Gasket Set

82886

Head Gasket Set 135 240 c/w Copper Gasket

1. **36812127** Head Gasket 135 240
2. **36811115** Rocker Cover Gasket 135 240 D 152 135
3. **36862143** Exhaust Manifold Gasket 135
4. **049135** Top Therm. Housing Gasket
5. **0490482** Therm. Housing Gasket
6. **0490485** Back Plate Gasket
7. **827877** Exhaust Elbow Gasket 135 35 35X 65
8. **62648** Gasket 135 Air Intake Manifold

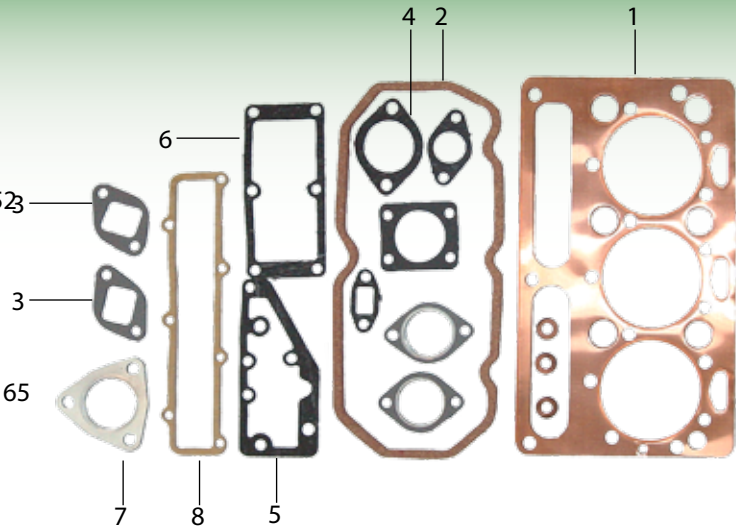

82886S

Head Gasket Set 135
c/w Plain Gasket

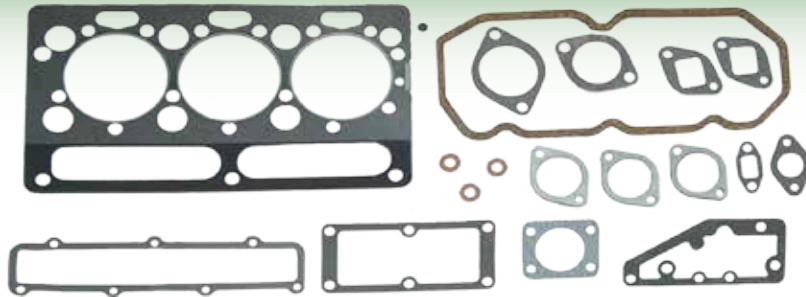

U5LB0011

Sump Gasket Set 135 240
Lip Seal

1. **049157** 35/135 Timing Cover Gasket
2. **0490514** Oil Filter Head Gasket
3. **0490685** Inj. Pump Gasket
4. **36817134** Rear Crank
5. **0490484** 35/135 Water Pump Gasket
6. **36862167** Fuel Lift Pump Gasket
7. **33826111** 135 Rear Lip Seal Gasket
8. **36862511** Speedo Seal Gasket
9. **61265** 135 Rear Timing Cover Gasket

82887

35/135 Sump Set
(Rope Seal)

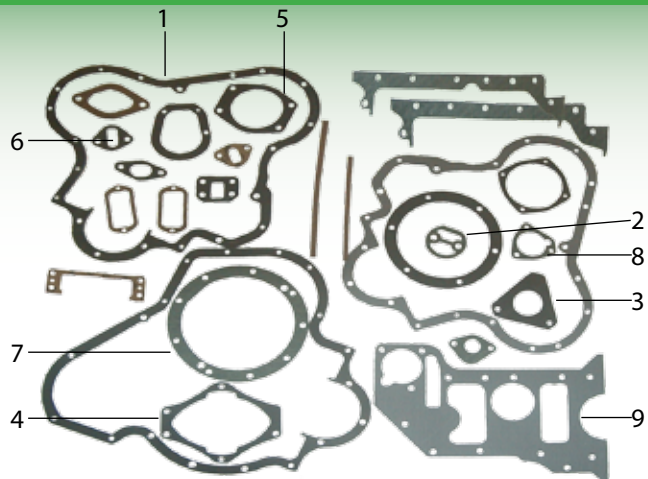

2049

Sump Gasket Set
240 Mini



62611

Back Plate Head
c/o Gasket

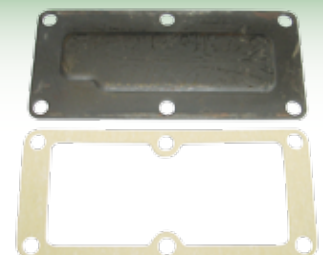

Gaskets

203 Gaskets

82908

Sump Gasket Set 203

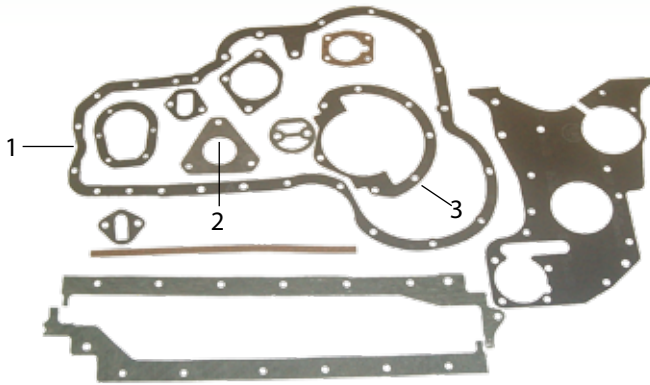

- 1. **36813144** Timing Cover Gasket 203
- 2. **0490685** Inj. Pump Gasket
- 3. **36817141** Crankshaft Gasket 203 Rear

82907

Head Gasket Set 203

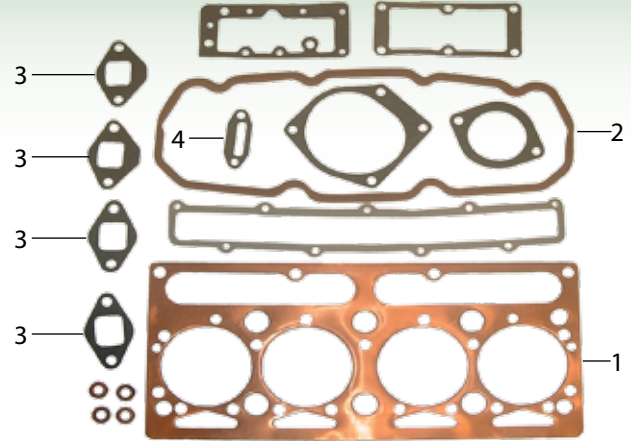

- 1. **36812138** Head Gasket 203
- 2. **36811112** Rocker Cover Gasket 203
- 3. **36862144** Exhaust Manifold Gasket 165 203 Eng
- 4. **0490702** Thermostat Housing Gasket 203

1542

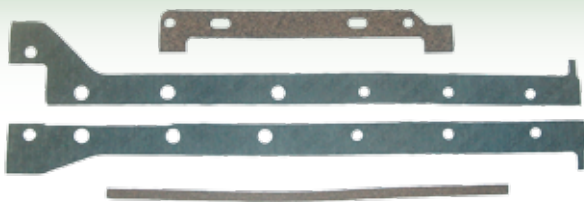

Sump Gasket Set 203
Old Mini

36884112
Packer

37556123

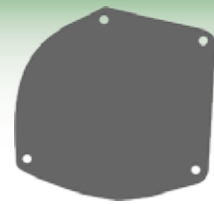

Water Pump Plate Back
203

1169

Angle Drive Gasket
165



36883106

Crankshaft Packer
35X 135 148 165-203
Rear



AD4.192 Gaskets

62946

Head Gasket Set
AD4.192

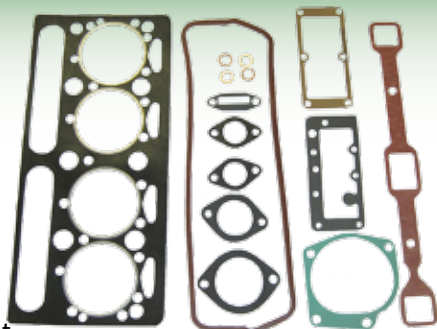

62947

Sump Gasket Set
AD4.192

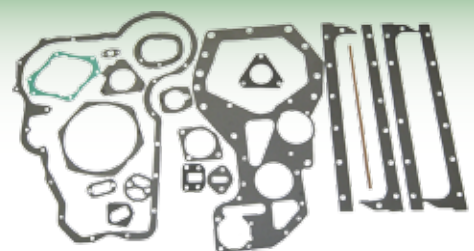

Gaskets

212/236/248 Gaskets

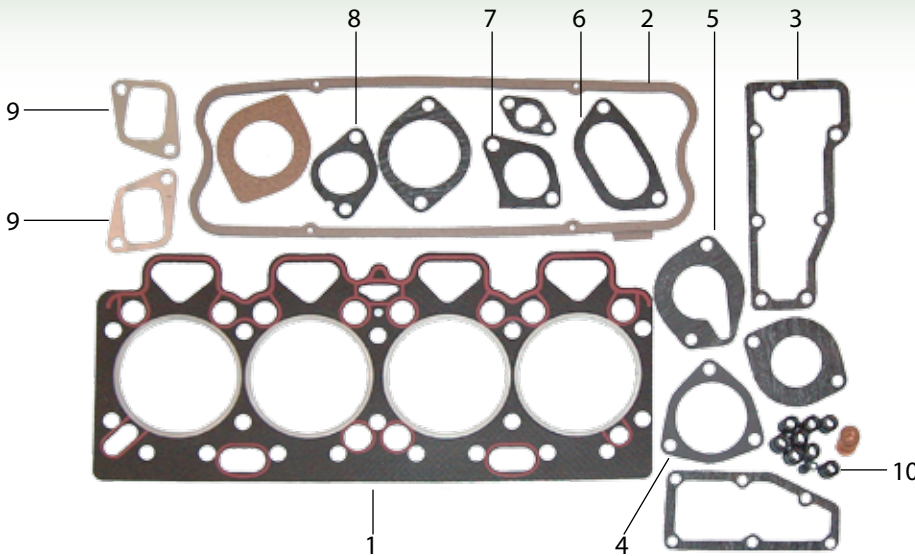

- | | | |
|-----|------------------|---|
| 1. | 36812338 | Head Gasket 212 236 248 |
| 2. | 36811122 | Rocker Cover Gasket 212 236 248 Cork |
| 2. | 3681A027 | Rocker Cover Gasket 212 236 248 Silicon |
| 3. | 36853514 | Water Pump Back Plate Gasket 212 ** Pack of 2 pieces ** |
| 4. | 194742 | Exhaust Elbow Gasket 165 168 (PACK 10) |
| 5. | 36862151 | Thermostat Housing Gasket 165 |
| 6. | 36862133 | Air Intake Manifold Gasket 212 248 |
| 7. | 36862132 | Air Intake Manifold Gasket 212 248 |
| 8. | 36862131 | Air Intake Manifold Gasket 212 248 |
| 9. | 36862134 | Exhaust Manifold Gasket 212 236 248 |
| 10. | 33817117 | Valve Stem Seal 212 248 - Packet of 8 |
| 10. | 33817117G | ** USE 33817117 ** |

3681E021

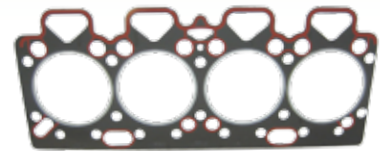

Head Gasket 236 -
Flame Ring Liner

53195

Exhaust Manifold Gasket
1104 5425 5460 6445 6470



3621F005

Cylinder Head Back Plate
212 248



68013

Sump Gasket Set 212
236 248

- | | | |
|-----------------------------|-----------------|--|
| 1. | 36815707 | Sump Gasket 212 236 248 |
| 2. | 36813137 | Timing Cover Gasket 212 248 Outer |
| 3. | 36817136 | Crankshaft Gasket 212 248 Rope Seal - Old |
| 3A. | 3641221 | Crankshaft Gasket 212 248 Lip Seal - New |
| 4. | 049003 | Filter Head Gasket 212 248 ** Pack of 2 ** |
| Oil Filter Head is 37764181 | | |
| 5. | 0490685 | Injector Pump |
| 6. | 36862166 | Fuel Lift Pump Gasket 2 Stud |
| 7. | 36866721 | Water Pump Gasket 165 290 ** Pack of 2 ** |
| 8. | 36867156 | Water Pump Gasket 212 236 |
| 9. | 36851113 | Fuel Lift Pump Gasket 4 Stud |

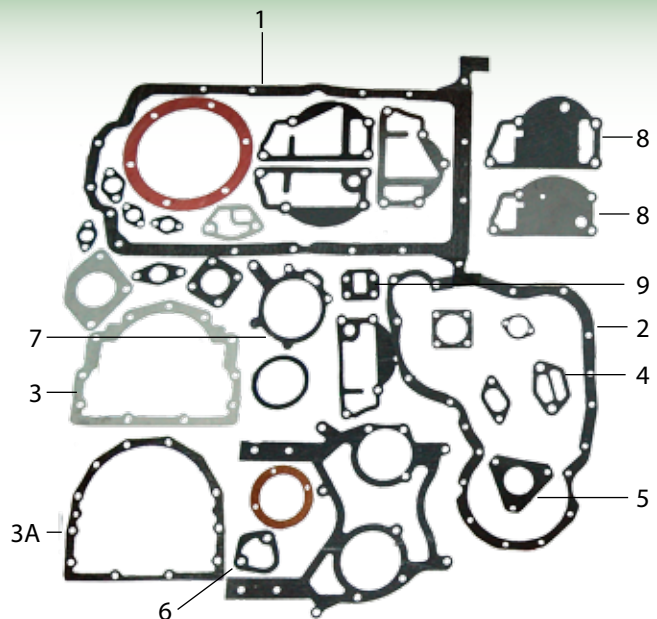

Gaskets

212/236/248 Gaskets

68250

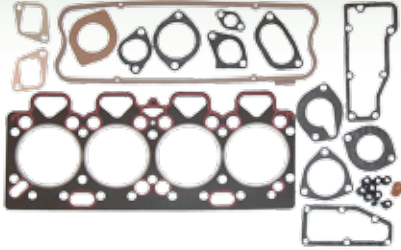

Head Gasket Set 212
236 248 c/w Flame Ring
for 165 188 290 590 690
Viton Seal ** Kit 61373 **

36812349



Head Gasket 236 - Flame Ring
Liner

3681E036



Head Gasket 4.236 Turbo
- From '86 *** Head Set
Complete is 68250 ***

U5LT0065



Head Gasket Set 236
248 365 390 Flush Liner

U5LT0046

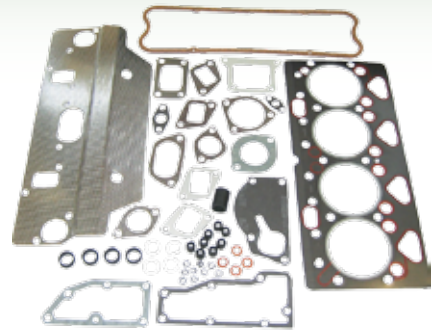

Head Gasket Set 236 698T

U5LT0015G



Head Gasket Set 212 236
165 188 290 590 690 c/w
Genuine Head Gasket -
3681E021

U5LB0045

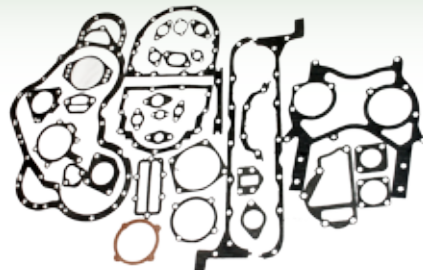

Sump Set 4236 Turbo JCB

Gaskets

4.318 / 595 Engine Parts

68211

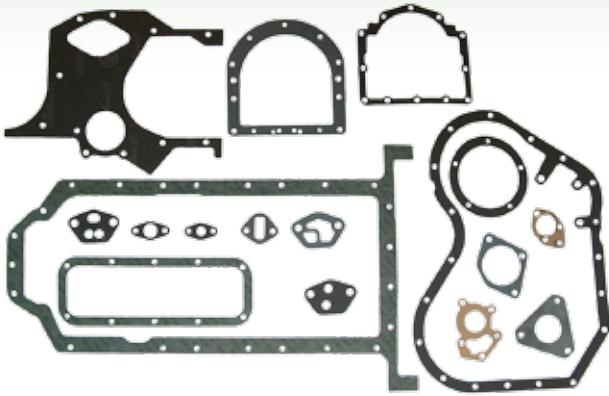

Sump Gasket Set 318

69048

Head Gasket Set A4.318 595 285
298 698

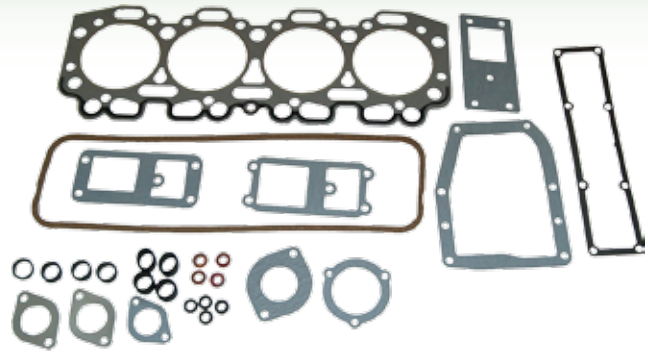

31434312



Push Rod 318

86812



Conrod 318 Engine

2415346

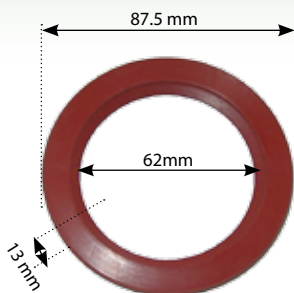

Oil Seal 595 Front Engine

3256326



Head Stud 595
(Modified)

62964



Conrod Bush 298 595 698
1004 A4.318 Engine
4 per Tractor

Phaser Gaskets 1000'S

4 Cylinder

U5LT0178

Head Gasket Set
Phaser 4 Cylinder
1004-4 and 1004-4T
Engine (Turbo/Non
Turbo)

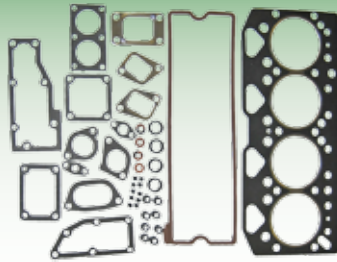

3681E037
Head Gasket Phaser 4 Cyl-
inder Turbo/Non Turbo

1090

Rocker Cover Gasket
4 Cylinder Phaser



6 Cylinder

U5LT0179

Head Gasket
Set 1000
Phaser



748329

Rocker Cover Gasket
6 Cylinder
Quadrant Engine
Joint

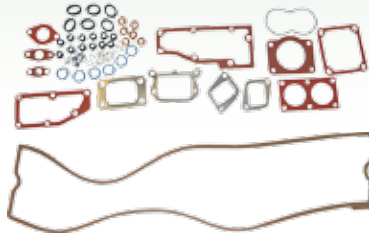

4 Cylinder Turbo

U5LB0051

Sump Gasket Set 4
Cylinder Turbo



6 Cylinder Turbo

U5LB0053

Sump
Gasket Set
6 Cylinder
Turbo



63413

Head Gasket Set 4235
4335 Tele Handler
8925 8926 8937 8939
AR Engine
OE Ref: U5LT0317

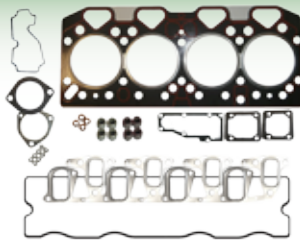

63414

Head Gasket 4235 4335
Tele Handler 8925 8926
8937 8939 AR Engine OE
Ref: 4223146M1



63339

Shim Rocker Cover
4260 4270 399
42 Series Series
Phaser Engines
1004 1006
OE Ref: 365691X1



63340

Washer Rocker Cover
42 43 Series Phaser
Engines 1004 1006
OE Ref: 376656X1



63341

Sealing Bush Rocker
Cover 4260 4270 399 42
Series 43 Series Phaser
Engines 1004 1006
OE Ref: 3638640M1



62094

Timing Cover Gasket Phaser Engine Inner



Gaskets

Perkins Phaser 1100 Series

3 Cylinder

62702

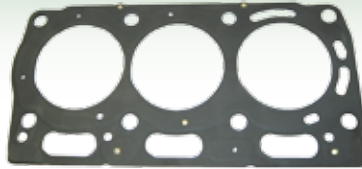

Head Gasket
1104 3 Cylinder

4 Cylinder

63029

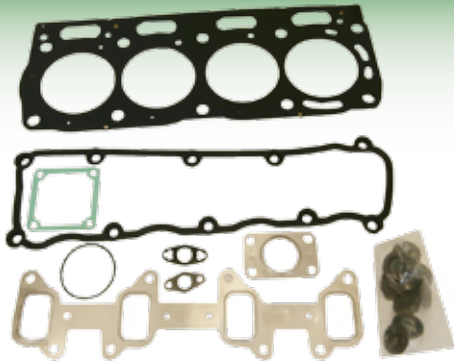

Head Gasket Set Perkins 1104C
5435 5455 5460 6445 6455 6460 6470

63032



Head Gasket Perkins 1104C 3445 3455 5445
5455 5460 6445 6455 6460 6470

63034



Sump Gasket 1104C
3445 3455 5445 5455 5460
6445 6455 6460 6470

63030

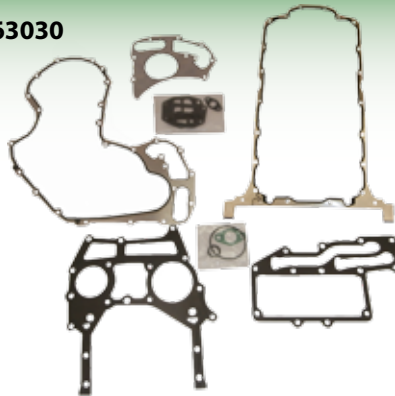

Sump Set Perkins 1104C-44
5435 5455 5460 6445 6455 6460
6470

63031

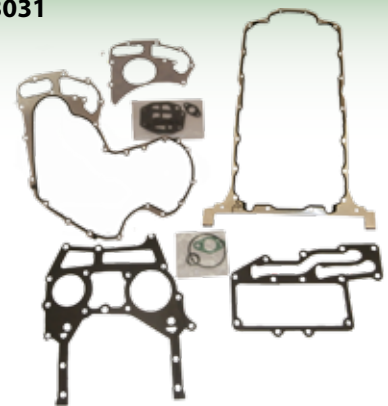

Sump Set Perkins 1104C-44T 3345 3455

63033



6455 6460 6470

Gaskets

Perkins Phaser 1100 Series

6 Cylinder

63035

Head Gasket Set Perkins 1106C 5465 6465
6475 6480

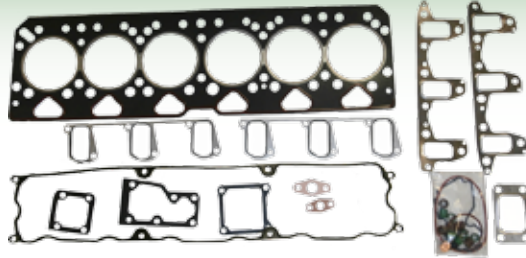

63037

Head Gasket 6 Cylinder
5465 6465 6475 6480
7465 7475 7480



63036

Sump Set Perkins 1106C 5465
6465 6475 6480 7465 7475
7480



63038

Rocker Cover Gasket 1106C
5465 6465 6475 6480 7465



Gaskets

6354 Gaskets

U5LB0020

Sump Gasket Set
6.354



36812607

Head Gasket 6354



36811412

Rocker Cover
Gasket 6354 Eng



36816702

Sump Gasket AT6354

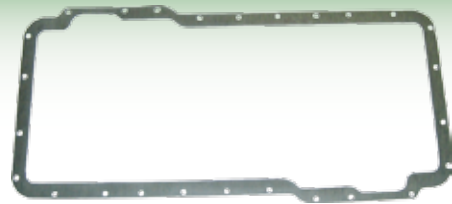

37467106

Exhaust Manifold
Gasket 6354



37467107

Exhaust
Manifold
Gasket 6354



37467108

Exhaust Manifold
Gasket 6354



Gaskets

6354,4 Gaskets

U5LT0017

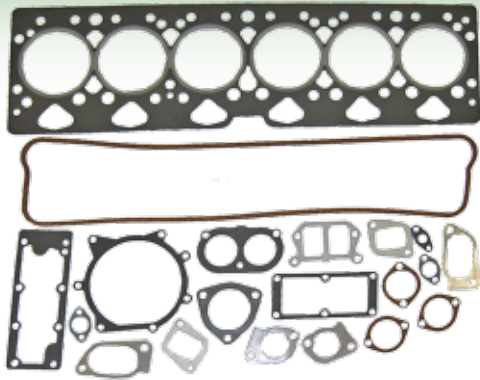

Head Gasket Set 2620 2640 6354.4

T6354,4 Gaskets

U5LB0049

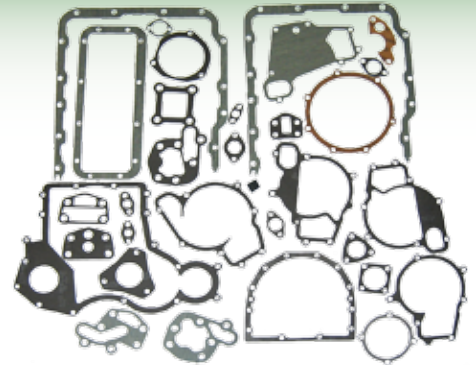

Sump Gasket Set 6354.4 - 2640 2720

U5LT0033

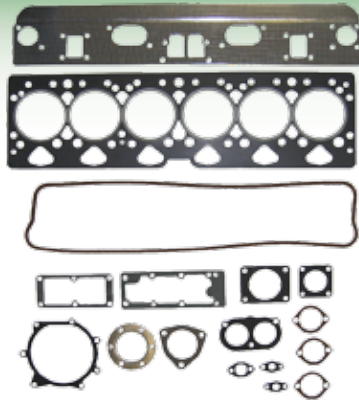

Head Gasket Set 699 Only
T6.3544

36811445

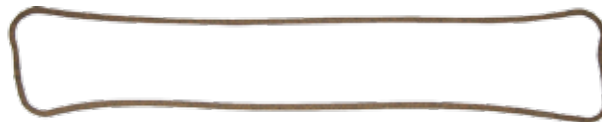

Rocker Cover Gasket 2640

Front And Rear Crankshaft Seals

<p>825208</p> <p>Crankshaft Seal TVO Rear</p>	<p>1884098</p> <p>Crankshaft Seal Rear 20D 35 4 Cylinder</p>	<p>825740</p> <p>Timing Cover Seal 20D (WRH11)</p>
--	---	---

<p>30854</p> <p>Rev Counter Drive Seal 35 135 ** Gasket is 36862511 **</p>	<p>2415343</p> <p>Engine Oil Seal 135 Front - Timing Cover Seal</p>	<p>2418F475G</p> <p>Lip Seal Perkins Black Genuine</p>	<p>2418F475</p> <p>Lip Seal Perkins 3.152 - 6.354 Engine Black</p>
---	--	---	---

<p>2415346</p> <p>595 Front Engine Oil Seal Perkins 318 Engine</p>	<p>2415361</p> <p>Timing Cover Seal 212 236 248 Front</p>
---	--

<p>36883106</p> <p>Crankshaft Packer 35X 135 148 165- 203 Rear</p>	<p>36883108</p> <p>Crankshaft Packer 212 236 248 Rear</p>
---	--

35/135 Engine Bearings

Big End Bearings

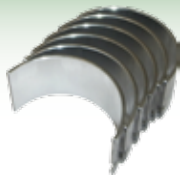

Model	Standard	10 Thou	20 Thou	30 Thou
TEA20	62383	62384	62385	62386
TEF20 35/4 Cyl.	63040	63041	63042	63043
A3.152	U5MB0014	U5MB0014A		
35/135	85036	85036A	85036B	85036C
203	85035	85035A	85035B	85035C
212/248	85042	85042A	85042B	85042C
236 Turbo	U5ME0006			



62631
Big End & Main Bearing &
Thrust Washer Kit St
165 188 290 390 590 690

Main End Bearings



Model	Standard	10 Thou	20 Thou	30 Thou
TEA20	62379	62380	62381	62382
TEF20 35/4 Cyl.	63044	63045	63046	63047
35/135	68084	68084A	68084B	68084C
203	68082	68082A	68082B	68082C
212/248	81558	81558A	81558B	81558C

Thrust Washers Kits

Thrust Washers

63057



Thrust Washer Kit
20TVO Standard

62378



Thrust Washer Set
35 FE TEF 20 Diesel



**Different Thrust Washers Are Required
When Fitting A New Crankshaft
To An Old Block For Ad152 Engine**

63058



Thrust Washer
Kit 35 135 3.152
Standard

63056



Thrust Washer Kit
212 248 Standard

Model	Standard	7 Thou Oversize	Undersize
35/135/203	Top 31137211	Top 31137212	Top 31137235
	Bottom 31137221	Bottom 31137222	Bottom 31137245
212/248	Top 31137551	Top 31137312	
	Bottom 31137561	Bottom 31137322	

Big End & Main End Kit

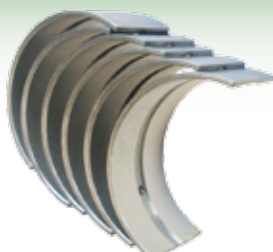

Model	Standard	10 Thou	20 Thou	30 Thou
A.152	61456	61457	61458	61459
212/236/248	61967	61968	61969	61970

Pistons, Liners, Rings









Engine Kit	Model	Liners	Piston C/O Rings	Piston	Rings	Piston Kit
	TEF20	61849		61847		
61385 (Chrome Liner)	35 Engine A3152	31358308 Light Lip Chrome (Perkins)	63376 Piston 35X C/O Cast Rings	43212 Piston 35X - Without Rings	41158058 for Chrome Liner (Perkins)	61848 Piston Ring TEF 20 20D
61369 (Cast Liner)		31358345H Cast	81512 Piston 35X c/w CHROME Rings Individual	43212 Piston 35X - Without Rings	41158057 for Cast Liner (Perkins)	61672 Piston Kit 35 35x c/o CHROME Rings - SET 3
61368 5 Ring Piston U5MK0701 Perkins Engine kit 63182 63185 Engine Overhaul Kit 135 240	135 Engine AD3152	31358345H Cast 31358345H Cast 31358357 30 Thou Oversize (Perkins)	68332		41158057 (Perkins)	61363
61372	148 Engine AD3152	31358345H Cast	U5PR0002			61366
61398	65/165 203 Engine	31358345H Cast Liner 31358308 Light Lip Chrome (Perkins)	68332		41158057 Cast Liner (Perkins) 41158058 Chrome Liner (Perkins)	61662

6184



33127107
Liner Shim 35 135

Pistons, Liners, Rings

Engine Kit	Model	Liners	Piston C/O Rings	Piston	Rings	Piston Kit
						
	TEF20	61849		61847		
61370	212	31358441H 31358441			41158045 3 Ring 41158044 4 Ring	61359 3 Ring Type
61373	236 168/175	31358441H 31358441 (Perkins)			41158026 41158041	
61373	236S 565/575 265/275	3135X032	68301		41158041 Service Pack 41158029	
61371	248 290/690	31358352H Lip Finish 31358352H	89207		4181A009 (6 Mm Bottom Oil Ring)	61365
	248S 290/590	31358352H Lip Finish		68367		
	248 390/690	6044 Flat Top Liner		U5LP0009H (3 Ring)	41158022 (3 Ring)	
61455	390	Flat Top Liner		(3 Ring)		
	236T 698T	Flat Top Liner 3135X032 (Perkins)		U5LP0006  U5LP0022 (Stepped Piston)	41158145 41158005	
	318 595 698	31358534 (Perkins) 31358534H	4 Ring Piston		41158118 4 Ring Sets	

Pistons, Liners, Rings

Engine Kit	Model	Liners	Piston C/O Rings	Piston	Rings	Piston Kit
	TEF20	61849		61847		
	318.8 698	31358534 (Perkins) 31358534H				
	6354 1200	31358441H (Hepolite)			41158026 41158041 Service Pack	
	6354.4 2640	31358441H (Hepolite)			41158017	
	T6354 1135	31358441H (Hepolite)		86726	41158031	
	T6354.4 2720/2680	31358441H (Hepolite)			41158005	
	399/699 A6354.4	31358441H (Hepolite)			41158005	
	4.270				41158121	
Phaser 1000'S Engine Parts						
4 Cyl Non Turbo	AA	3135X042			63135	
4 Cyl Turbo	AB	3135X042		U5LL0014 63132	4181A026 63134	
6 Cyl Non Turbo		3135X042		U5LL0021 63133	4181A027	
6 Cyl Turbo		3135X042		U5LL0014	4181A026	



U5MK0709
Engine Overhaul Kit 4 Cylinder
Phaser Turbo Engine Number
Starting With AB



62276
Ring Kit Phaser
4 Cylinder Turbo









4181A033
Ring Set To Suit
AK Engine



U5MK0810
Engine Overhaul Kit 4 Cylinder
Phaser Turbo Engine Number
Starting With AK

Pistons, Liners, Rings

Model	Engine Type	Engine Kit	Piston Kit	Single Piston	Rings	Liner
						
MF 35 C/O Chrome Liners	A3.152	61385 C/O Chrome Liners Includes Oil Pump		63376 c/o Cast Rings	41158058	31358308 Chrome Liner
MF 35 C/O Cast Liners	A3.152	61369 C/O Cast Liners Includes Oil Pump	61672	81512 c/o Cast Rings	41158057	31358345H 31358357 30 Thou Oversize
MF 135 MF 240	AD3.152	61368 Includes Oil Pump	61363	68332		31358345H 31358357
MF 148 MF 250 MF 550	AD3.152	61372	61366	USPR0002		31358345H 31358357
MF 65/165-20	A4.203	61398 Includes Oil Pump				
MF 168/265/275 565/575/675	236	61373 C/O Oil Pump				
165	212	61370 C/O 3 Ring Piston	61359 3 Ring Type		411580444	31358441H
168 265-275 565-575 675	236				41158026 41158041 Service Kit	31358441H Genuine
362-365 375 3050	236			68301 C/O Rings	41158026 41158041	3135X032
188, 290 590, 690	248	61371 C/O Flame Ring Liners	61365	89207	4181A009	31358352H
390 3060	248			U5LP0009H 3 Ring Type C/O Rings	41158022	6044 Flat Top Liners
390 3060	248	61455			41158022	6044

Engine Parts

1000

Engine 135 240 Complete
Cylinder Head to Suit -
62981



62981



Cylinder Head 135 240 to
Suit 1000

62982



Thermostat Bottom
Housing To Suit
1000

63138



Injector 3 Cylinder to Suit
1000







1000P

Engine 135 240 Original Type
Complete with Electrics, Fuel Injection System
Radiator, Cowl, Fan and Water Hoses



Engine Parts

TEF-20 Diesel 1951-1956

<p>61847</p>  <p>Piston TEF 20 20D</p>	<p>61849</p>  <p>Piston Ring TEF 20 20D</p>	<p>61848</p>  <p>Piston Ring TEF 20 20D</p>	<p>63263</p>  <p>Liner Cuff Ring TEF20</p>	<p>63262</p>  <p>Liner Cuff Ring TEF20 20C</p>
<p>63008</p>  <p>Crankshaft TEF20 Diesel 4 Cylinder</p>	<p>61430</p>  <p>Timing Chain TEF 20 20 D - 43 Links c/w Joine</p>	<p>826113</p>  <p>Timing Chain Tension 20 TVO 20 D 35 4 Cylinde</p>	<p>61671</p>  <p>Oil Pump Rotor 20 D 35 4 Cylinder</p>	
<p>61840</p>  <p>Pre Cleaner Assembly TEF 20 20D - 40mm Air Hat</p>	<p>41428</p>  <p>Injector Pump Diaphragm TEF20</p>	<p>61841</p>  <p>Thermostat Housing TEF20 Diesel</p>		
<p>41105</p>  <p>Exhaust Valve Guide TEF20</p>	<p>62109</p>  <p>Conrod Bush TEF20 20D Engine - SET 4</p>	<p>62377</p>  <p>Ring Gear 20D</p>		
<p>1884098</p>  <p>Crankshaft Seal Rear 20D 35 4 Cylinder</p>	<p>825740</p>  <p>Timing Cover Seal 20D (WRH11)</p>			
<p>62163</p>  <p>Camshaft Gear TE 20</p>	<p>62164</p>  <p>Crankshaft Gear TE 20 21 teeth</p>			
<p>63146</p>  <p>Oil Pressure Pipe To Gauge 20 Diesel Short</p>	<p>63147</p>  <p>Oil Pressure Pipe From Block 20 Diesel Long</p>			

Engine Parts

20 Petrol/TVO

62662
Plug Leads c/w Closed Screw Connections

62656
Plug Leads 20 c/w Covers Push In Connections

51942
Acorn Cap for Coil TE20 TVO 20 Long *** For 62513 & 62515 ***
Long

51941
Acorn Cap for Distributor Cap Pack of 5 Short *** For 61342 ***
Short

62515
Coil 12V Old Type TE 20 TVO 20 *** Acorn Cap 51942 ***
Screw In Type

61342
Distributor Cap 20 TVO *** Acorn Cap 51941 ***

63065
Spark Plug Cap Champion

63019
Coil 12V New Push in Connection Type TE20 TVO20 ** Old Type is 62515 **

61524
Distributor Cap 20 TVO Rotor

61343
Condenser 20 TVO

62513
Coil 6V Old Type T E20 TVO 20 *** Acorn Cap 51942 *** 1.5 Ohms **Screw In Type**

61344
Points 20 TVO

61345
Spark Plug 20 TVO 35 4 Cylinder ** Long Reach N21 **

63338
Ignition Kit 20

Includes:
61344 61343
61345 x 4
61524

63306
Bearing Distributor 20 Late Type 1/2" x 1 5/16" x 3/8"

63307
Bearing Distributor 20 Early Type 1/2" x 1 1/8" x 5/16"

Engine Parts

20 Petrol/TVO

TE-20,TEA-20,TEB-20,TEC-20, TED-20,TEE-20

61300



Ring Gear 20
TVO

63007



Crankshaft TEA20 Petrol TVO

62933



Liner TEA20

63264



Thermostat Housing TE20
TE20A TE20D Top

63278



Caburettor 20 TVO Petrol
Marvel Schebler ** Zenith
is 63277 **

63277



Carburettor 20 TVO Petrol
Zenith Style ** 63278 is
Marvel Schebler **

62797



Carburettor Repair Kit
Zenith Style

62768



Carburettor Repair Kit
135 35 Petrol

825208

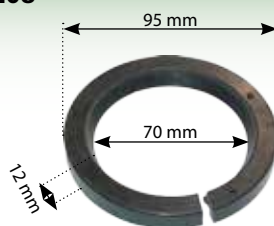

Crankshaft Seal
TVO Rear

825740



Timing Cover Seal
20D (WRH11)

63286



Oil Seal Timing Cover 35 Petrol 135
Petrol TEA20 TED20

Engine Parts

20 Petrol/TVO

TE-20,TEA-20,TEB-20,TEC-20, TED-20,TEE-20

61286



Conrod Bush
20 TVO

61325



Plate Governor Weight
Assembly TE 20

825157



Cup and Shaft Assembly 20 D
Also fits 135 35 TE20 TE20A
TE20D

61292



Conrod Locking
Tabs 20 TVO

61291



Flywheel Locking
Tabs 20 TVO

825259



Valve Guide TE 20
Inlet & exhaust, ID
7.88mm, OD 12.75mm

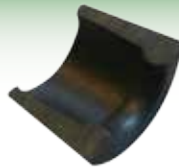

63404
Valve Cotter TE20 35 135
Petrol
[OE Ref:825258M1](#)

61842



Heat Shield TE 20 - Heavy Duty
135 Petrol 35 Petrol

61567



Oil Pump Rotor TE 20
(Petrol)

61777



Spark Plug Scrambler /
Chainsaw - SET 4

61289



Timing Chain 20 TVO
- 29 Links

826113



Timing Chain Tension
20 TVO 20 D 35 4 Cylinder

53228







Chain Tensioner Repair
Kit Perkins P3 P4 P6

53227



Chain Tensioner Assembly
Perkins P3 P4 P6

35 4 Cylinder Engine Parts

<p>62045</p>  <p>Crankshaft Pulley TE 20 35 Front</p>	<p>825259</p>  <p>Valve Guide TEA20 TED20 35, 35 Petrol, 135, 135 Petrol</p>	<p>61671</p>  <p>Oil Pump Rotor 20 D 35 4 Cylinder</p>	<p>826127</p>  <p>Angle Drive 35 4 Cylinder Cable = 61116 48" Long</p>
---	--	---	--

<p>826113</p>  <p>Timing Chain Tension 20 TVO 20 D 35 4 Cylinder</p>	<p>61429</p>  <p>Timing Chain 35 4 Cylinder - 31 Links</p>	<p>825102</p>  <p>Frost Plug 20 D 35 4 Cylinder - 1¼ 32.18mm</p> <p>61396</p> <p>Frost Plug 20D/35 4 Cyl Small - 1¼ 32.18mm</p>
--	---	---

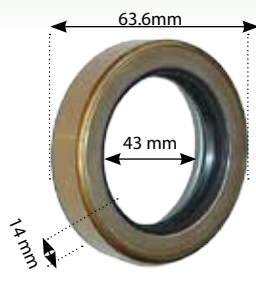
<p>1884098</p>  <p>Crankshaft Seal Rear 20D 35 4 Cylinder</p>	<p>825740</p>  <p>Timing Cover Seal 20D (WRH11)</p>
---	--

<p>63322</p>  <p>Piston Assembly FE35 23C 35 4 Cylinder</p>	<p>63370</p>  <p>Liner FE35 Industrial 702 35 4 Cylinder</p>	<p>61296</p>  <p>Ring Kit 135 Petrol 35 Petrol 35X 80.96mm</p>
---	---	--

35/135 Engine Parts

6932

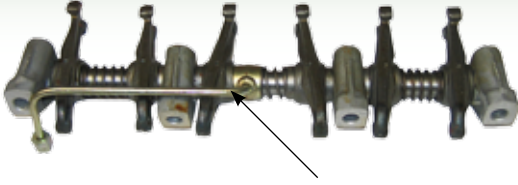

Rocker Shaft 135 Complete **35568352**
Fuel Injection Pipe 135

0860012

Cam Follower 135 140 145
148 165 Tappet



- 1. **37747581** Thermostat Housing 135 Top
- 2. **049135** Top Thermostat Housing Gasket
- 3. **2485666** Thermostat 82| All Models
- 4. **37766361** Thermostat Housing 135 5/8" UNF FOR BLANK
- 5. **0490482** Thermostat Housing Gasket 35 135 Pack of 2

37188571



Rocker Cover 135
Steel

36811115



Rocker Cover Gasket 135
240 D 152 135

61882



Blow off Pipe for Rocker
Cover 135 240

62361

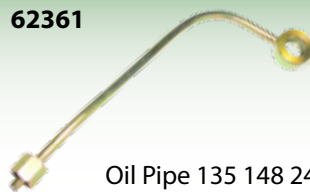

Oil Pipe 135 148 240
Head to Block

62362

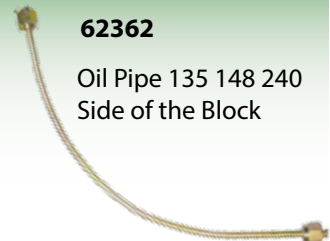

Oil Pipe 135 148 240
Side of the Block

62611

Back Plate Head
c/o Gasket

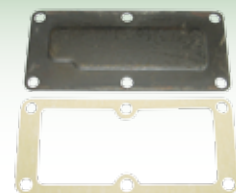

Engine Parts

MODEL - 35/35X

ZZ80048



Cylinder Head 35 / 35X c/o Valves

37416511

Combustion Cap
35X 65 Dexta



0490023

35X Combustion
Cap Gasket



Stud = 082075 Nut = 353431

ENGINE - A3.152

2175 Cylinder Head Stud Kit 35

8 X 32524133 4 1/4'x7/16'
6 X 32524132 3 5/8'x7/16'
4 X 32754411 3 9/16'x3/8'x5/16'

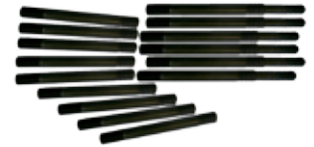

MODEL - 135/240/250

ZZ80082



Cylinder Head 135 c/o
Valves

33221327

Conrod Nut 35
135 7/16" UNF



ENGINE - AD3.152

2176

Cylinder Head Stud Kit 135

5 X 32524132 3 5/8' x 7/16'
13 X 32524131 4 1/8' x 1/8' x 7/16'
4 X 32754412 3 9/16' x 3/8' x 5/16'



32181446



Cylinder Head Stud 135

32181459



Cylinder Head Stud 135 - Short

32181447



Cylinder Head Stud 135 Long

37786301

Inlet Manifold 135

Heater Plug = 2666103
Gasket = 41218



AD4.192

62945



Cylinder Head AD4.192

AD4.203

62944



Cylinder Head AD4.203

Engine Parts

MODEL -35-35X

ENGINE - A3.152

62948

Valve Kit A3.152 35



63067

Valve Inlet 35 65 A3.152 A4.203

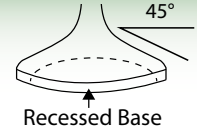

63068

Valve Exhaust 35 65 A3.152 A4.203

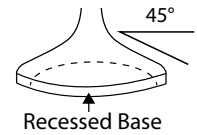

63072

Valve Exhaust 135 240 AD3.152 A4.203

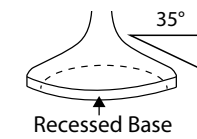

MODEL -135 240 250 550

ENGINE - AD3.152

61827

Valve Kit 135 3 Cylinder



63069

Valve Inlet 135 240 AD3.152 A4.203

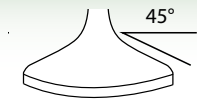

63070

Valve Exhaust 135 240 AD3.152 A4.203



63072

63071



62745

Valve Cotter 135



62709

Valve Cap Top 35 135 240



62710

Valve Cap Bottom 135 148 240



63096

Valve Spring A3.152 A4.203 35 135 Outer



63099

Valve Guide Inlet & Exhaust A3.152 A4.203



AD152 Engine Parts

ZZ90084



Crankshaft 35 135 Rope Seal c/o Bearings AD3.152 Keyway on Nose

94458



Crankshaft 135 240 Lip Seal c/o Bearings AD3.152 Keyway on Nose

62956



Crankshaft 65 MK2 165 MK1 c/o Bearings 4 Cylinder Rope Seal Perkins 203 Engine

35/135/240 Pulley

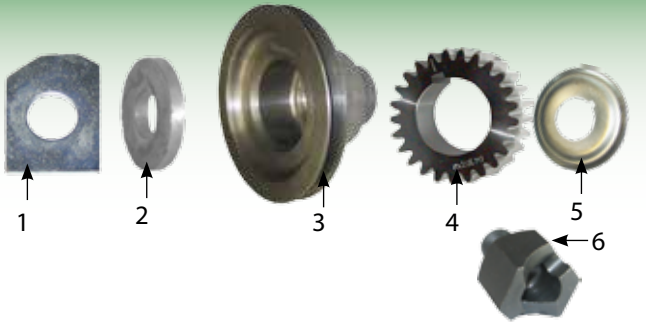

1. **31731515** Weight Locking Tab
2. **33125124** Front Crankshaft Pulley Spacer 135
3. **62612** Pulley Crankshaft 35 135 c/w Key Kit
4. **0410132** Crankshaft Gear 135
5. **62550** Crankshaft Washer 135
6. **62637** Starter Bolt For Crankshaft 35 135 148
7. **36271704** Key Crankshaft 35 135 Front

35/135 Rope Seal Housing

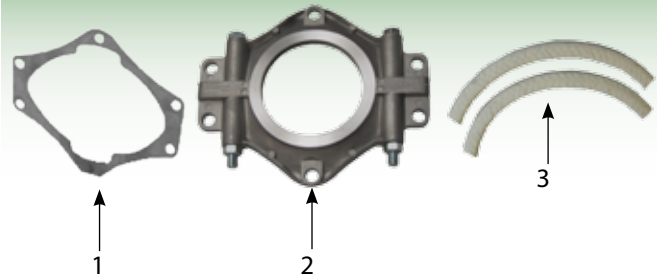

1. **36817134** Crankshaft Gasket 152 Rear
2. **41422034** Rope Seal Carrier 35 135
3. **36883106** Crankshaft Packer 35X 135 148 165-203 Rear

Con Rods



Kit 63183

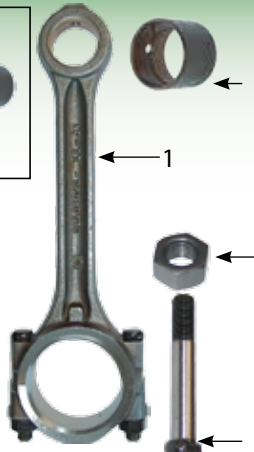

1. **91051** Conrod 135 D152 203
2. **31134151** Small End Bush
3. **0095250** Conrod Bolt 35 135
4. **33221327** Conrod Nut
5. **63183** Conrod Overhaul Kit 135 240

ZZ90011



Conrod 35 65 MK1

135/240 Lip Seal Housing

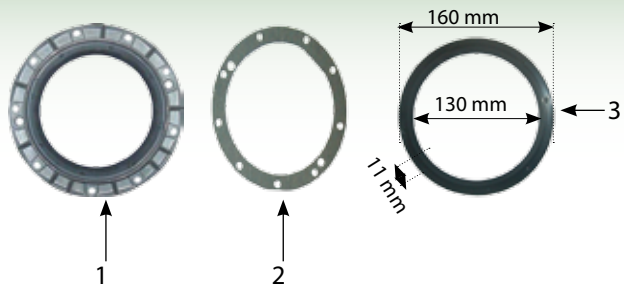

1. **37424611** Carrier 135 240 Lip Seal c/o Seal
2. **33826111** Lip Seal Gasket 135 Rear
3. **2418F475** Lip Seal Perkins 3.152 - 6.354 Engine BlackRear Crankshaft seal Lip Seal

61589



Oil Pressure Pipe Union TE 20 35

37732901



Cylinder Block Elbow 35 35X 135 148

899451



Pipe 135 Oil Pressure Short

899453



Pipe 135 Oil Pressure Long

135 Timing Cover Assembly

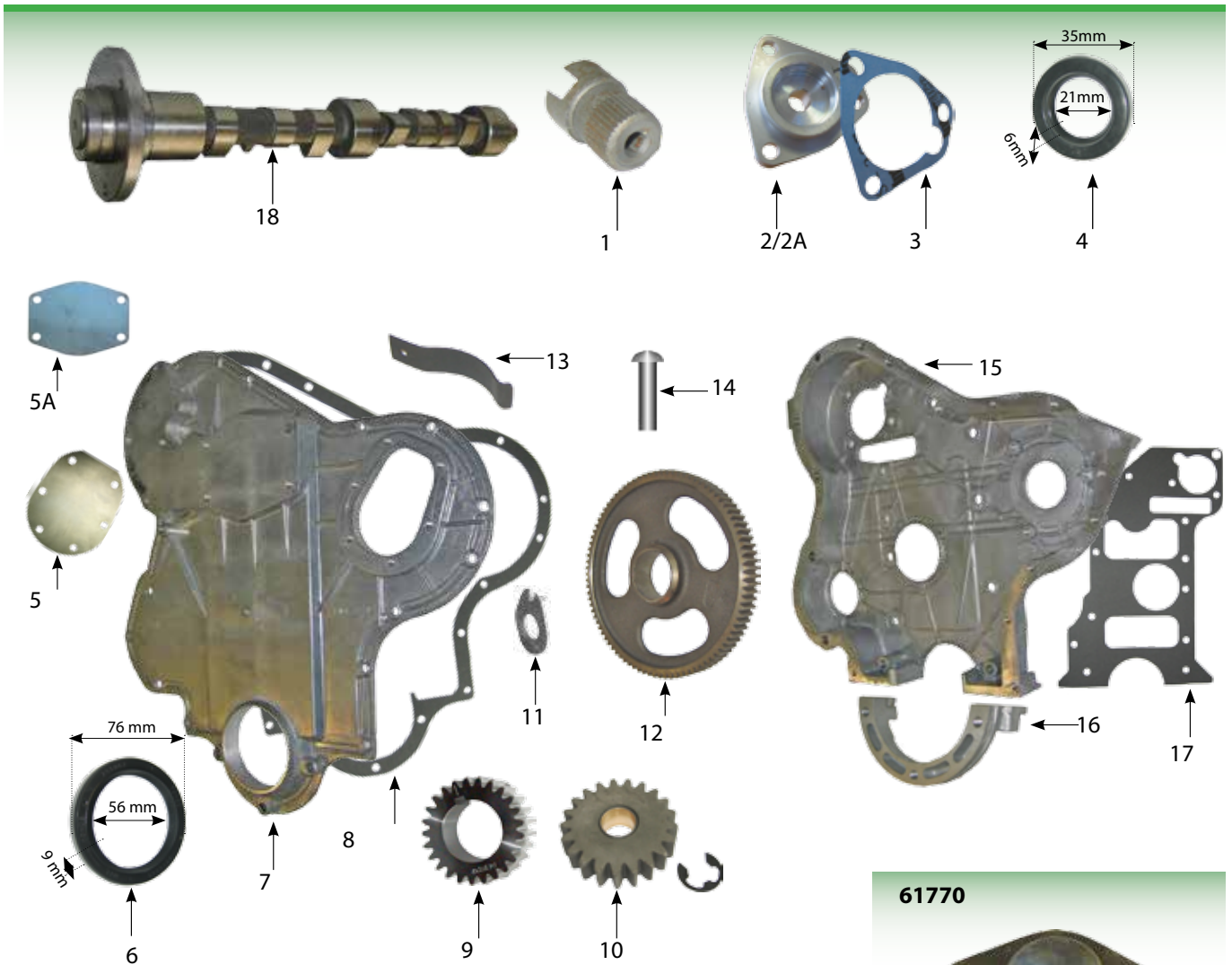

- | | | |
|----|------------------|--|
| 1 | 33473106 | Rev Counter Drive End 35 65 135 |
| 2 | 37416751 | ** Kit is 37416751K ** |
| 2A | 37416751K | Rev Counter Drive Housing 35 135 Kit c/w Seal |
| 3 | 36862511 | Rev Counter Gasket 35 135 Pack of 2 Seal=30854 |
| 4 | 30854 | Rev Counter Drive Seal 35 135 |
| 5 | 62646 | Blanking Plate Oil Filler 3152 35 135 |
| 5A | 3623H004 | Water Pump Back Plate - Stainless Steel |
| 6 | 2415343 | Engine Oil Seal 135 Front - Timing Cover Seal |
| 7 | 37167791 | Timing Cover 135 Outer |
| 8 | 049157 | Timing Cover Gasket 35 135 |
| 9 | 0410132 | Crankshaft Gear 135 |
| 10 | 62613 | Oil Pump Idler Gear c/w Circlip |
| 11 | 0920883 | Idler Gear Lock Plate 135 |
| 12 | 31164362 | Timing Cover Idler Gear 135 |
| 13 | 0780067 | Timing Cover Assembly Camshaft Spring 135 |
| 14 | 2126466 | Rivet for Camshaft Spring |
| 15 | 996257 | Timing Cover 135 Inner |
| 16 | 37354312 | Timing Gear Cover 35 135 148 240 250 |
| 17 | 61265 | 135 Rear Timing Cover Gasket |
| 18 | 31415261 | Camshaft 35 135 |

61770



Power Steering
Pump Cover 135 240

62949



Oil Filler Tube
Engine 3.152

AD152 Block Parts

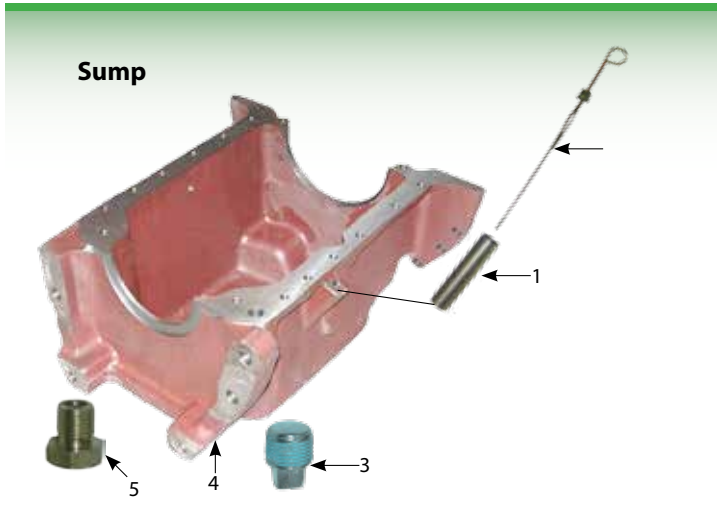

- 1. **33242407** Dipstick Tube 135
- 2. **31786412** Dipstick 35 135 200
- 3. **0650540** Sump Plug 35 1/2" GB Plug
- 4. **37172493** Sump 135 240 Lip Seal
- 5. **4174** Sump Plug Ford & 135 (3/4'-16 Thr)
- 6. **4139** Sump Plug 'O' Ring / Washer Ford 3/4" ID

61129



Engine Block 135 3
Lip Seal

37813113



Blanking Plug - Ring
Gear Flywheel 100
200

		Frost Plug	
0650566	Frost Plug 135	11/16"	18mm
32417156	Frost Plug 399	13/16"	21mm
0650567	Frost Plug	1"	25.4mm
0650563	Frost Plug 135 165	1 1/4"	32mm
61396	Frost Plug 20D/35 4 Cyl Small	1 1/4"	32mm
0650618	Frost Plug 135 165	1 3/8"	35.3mm
0650577	Frost Plug 135 165	1 1/2"	38.5mm
825102	Frost Plug 20 D 35 4 Cylinder	1 3/4"	44.5mm
32416105	Plug - Camshaft 212/236/248 Engine	2"	50mm

37764251



Oil Filter Head 135

0490514



135/148 Oil Filter Head Gasket

62610



Oil Filter Head c/o Gasket
and Bolts

Oil Pumps & Related Parts

35/135 Oil Pump

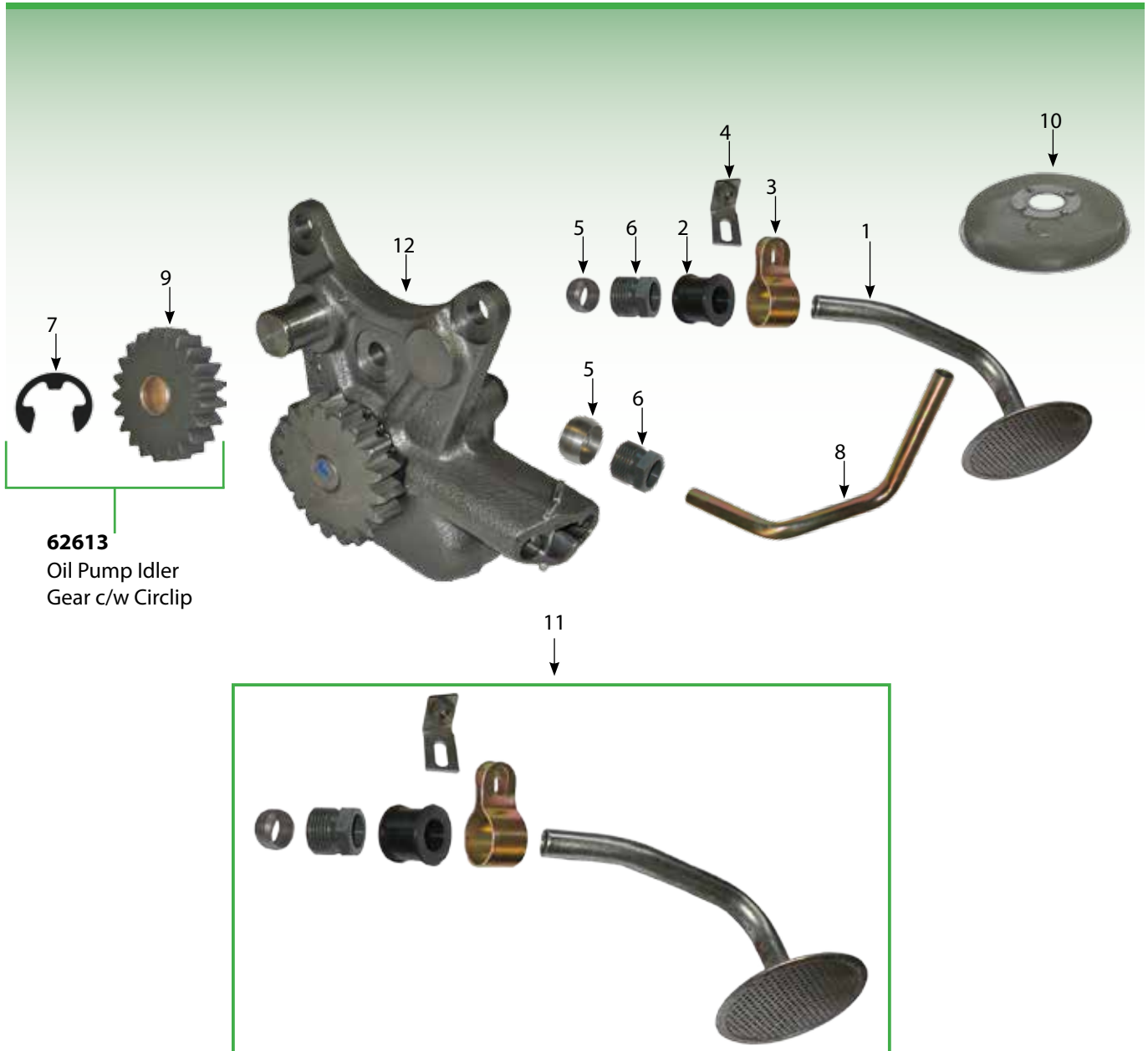

62613
Oil Pump Idler
Gear c/w Circlip

- | | | |
|-----|-----------------|---|
| 1. | 35137611 | Suction Pipe 3152 AD3152 ** USE 3831 ** |
| 2. | 33817308 | Rubber Bush for Suction Pipe ** USE 3831 ** |
| 3. | 36631118 | Clip for Suction Pipe ** USE 3831 ** |
| 4. | 38121531 | Oil Pump Pipe Bracket for Suction Pipe ** use |
| 5. | 0560244 | Olive for Suction Pipe |
| 6. | 33532121 | Nut for 3.152 Pump Suction Pipe ** USE 3831 * |
| 7. | 0180831 | Idler Gear Circlip |
| 8. | 34711129 | Oil Delivery Pipe 35 135 148 240 550 |
| 9. | 41115008 | Oil Pump Idler Gear |
| 10. | 61196 | Sump Strainer 35 Old Type |
| 11. | 3831 | Suction Pipe Kit 35 135 Mod. |
| 12. | 41314078 | Oil Pump 35 135 |

212/236/248 Engine Parts

0410236

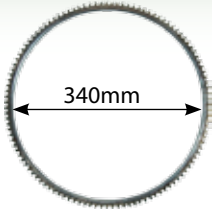

Ring Gear 152 212 236
248 - 115 Teeth

31161148

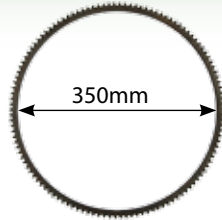

Ring Gear 699 &
399 - 6.354.4 Engine
4260 4270 Blue
Green 118 Teeth

41117084



Flywheel Assembly
188 590 12"

61132



Flywheel 390 390T 398
4200 4 Cyl 13" 4225 4235
4240 4245 4255 4265
4345 4355 4365

63006



Crankshaft Rope Seal
168 175 188 A4.236
A4.248

94434



236/248/Phaser
Lip Seal Crankshaft

61865



Locking Tab
Kit 35 135
165 390

0921062

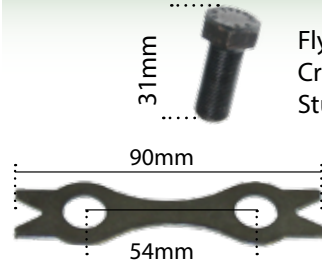

Flywheel Locking Tabs

61879

Flywheel
Crankshaft
Stud 100

ZZ90013

Conrod T4.236
6354.4 Turbo



84920

Conrod
212 248

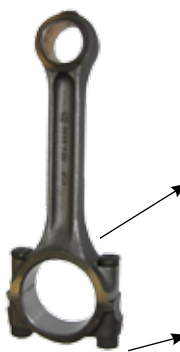

31134123

Bush 212 248
Small End



32762116

Conrod Bolt
212 248



33221321

Conrod Nut
212 248



3242T001K



Crankshaft Block Front
c/o Bolts

62962



Bolt & Washer Kit
Crankshaft Pulley 165 285

3242T001

Crankshaft
Block Front



32186139

Crankshaft Bolt
Front New Type



Kit=3242T001K



- 61875**
- 33125124**
- 31148711**

Crankshaft Pulley Stud 203 248 Engine
Spacer
Crankshaft Pulley 200 500

212/248 Timing Cover Assembly

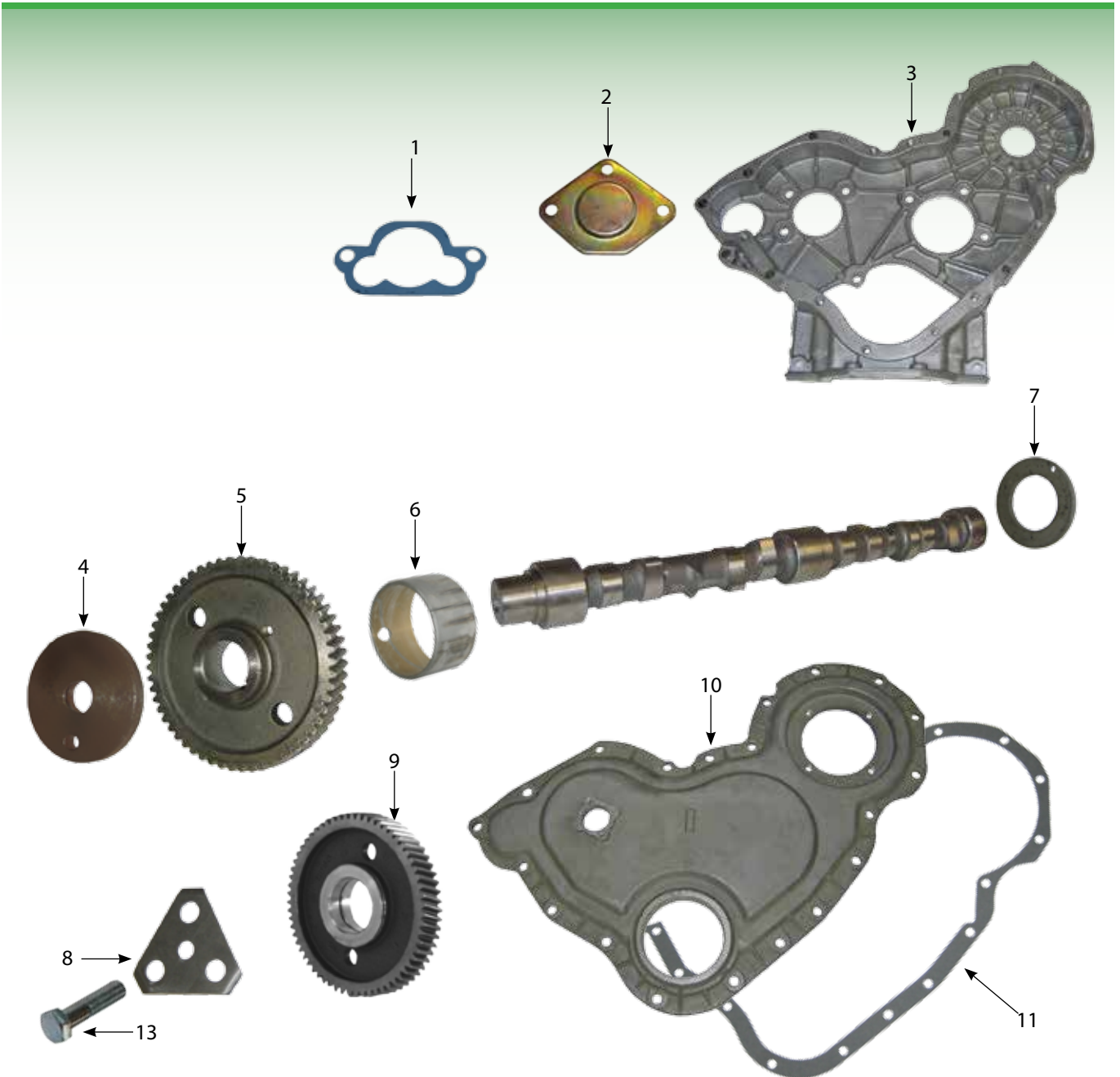

- | | | |
|-----|-----------------|---|
| 1. | 1833974 | Power Steering Pump Gasket Pump=897146 |
| 2. | 37556148 | Power Steering Pump Blanking Plate |
| 3. | 6994 | Timing Cover Casing 165 285 Inner |
| 4. | 33153128 | Camshaft Spacer 212 248 |
| 5. | 31171353 | Camshaft Gear 212 248 Engine |
| 6. | 31134132 | Camshaft Bush 178 188 275 290 362 - 398 |
| 7. | 33153121 | Camshaft Washer 212 248 |
| 8. | 0921246 | Idler Gear Tab Washer 212 248 |
| 9. | 41115023 | Timing Cover Idler Gear 212 |
| 10. | 6995 | Timing Cover 165 285 Outer |
| 11. | 36813137 | Timing Cover Gasket 212 248 Outer |
| 12. | 2415361 | Front Timing Cover Seal 212/236/248 |
| 13. | 353550 | Bolt 3/8' x 2 1/2' UNF Zinc & Yellow |



212/236/248 Block Parts

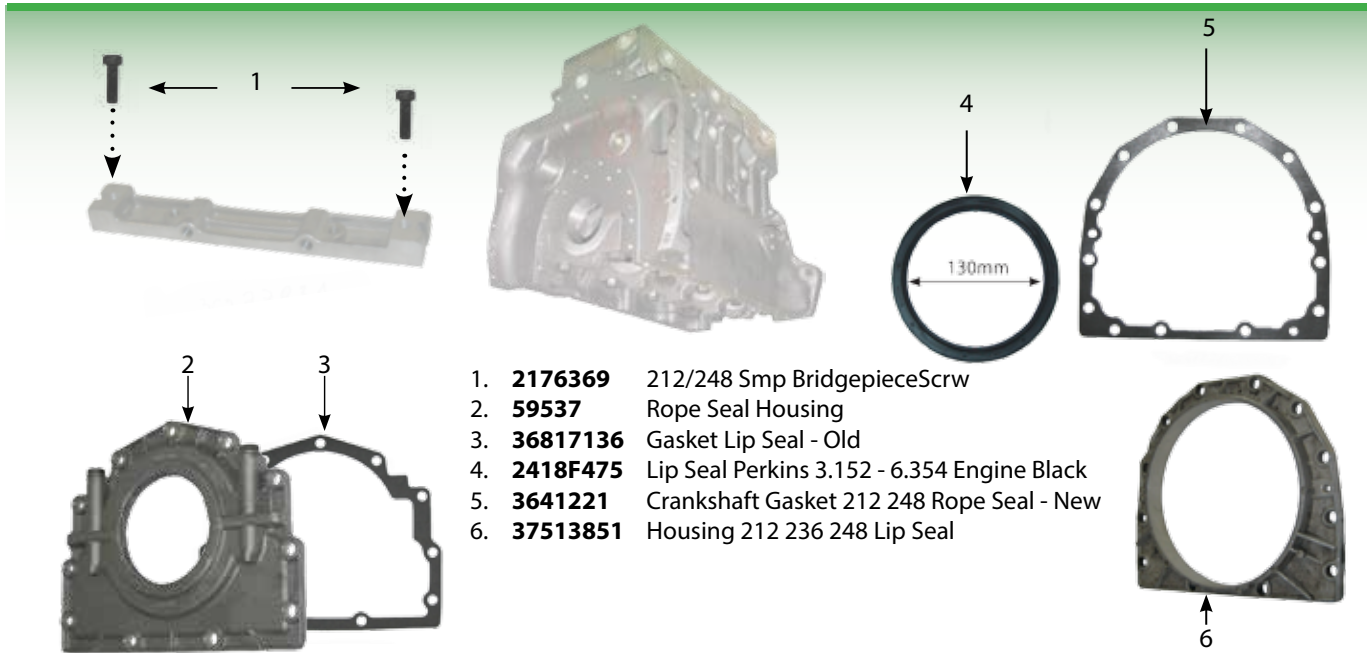

3641805

Dipstick 390 Outer Sheath
- Use Kit 61668

61668

Dipstick Assembly 300's 4
Cylinder Engine Dipstick

31787437
Dipstick 212 248

3178C106
Dipstick 236T

6342

Oil Filter Housing
Blizzard Engine 698T
>1984 362N 374 382
384 393 394 396 397
698T 1004T 1007

33533103

Dipstick
Tube Nut
212-248

0746610

Retaining
Stud 165
Filter Head

049003

Filter Head Gasket

37764181

Oil Filter Head 165
Thread 3/4" UNF
** Gasket is 049003 **
Filter=2654403

62445

Oil Filler Cap
595 698

2487841

Engine Oil Filler Cap

61493

Engine Oil Filler Cap
3100 3600 4200 4300
Also fits 6100 6200
8100 Screw Type

61492

Engine Oil Filler Cap
399 3100 3600 3085
3095

6992

Oil Filler Neck 165
285 Grey

6744

Oil Filler Neck
165 285 Lockable

212/248 Engine Parts



1. **2172513** Allen Screw 165 175 185
2. **37188549** Rocker Cover 165 - 212 236 248
3. **36811122** 212-248 Cork Rocker Gasket. Silicone is 3681A027
4. **0170151** Rocker Shaft Circlip 212 248
5. **62609** Rocker Shaft Phaser 4 Cylinder 212 248
6. **35511111** Rocker Shaft Delivery Pipe
7. **376525** Rubber Olive 1/4" (Pack of 10)
8. **0720579** Rocker Adjuster 100 200 500 600

62554



Inlet Manifold 165 285

ZZ80054



Cylinder Head 212 236 248 390 c/o Valves

61828



Valve Kit 236 248 4 Cylinder

31434162 Valve Tappet 236



62708 Valve Cap Top 165 185 265 285



61201



Exhaust Valve Seat

61202



Exhaust Valve Seat

63092 Collet 212 236 248 1004 1006



63094



Valve Spring 236 248

63097 Valve Guide Exhaust 212 236 248 1004 1006



63098 Valve Guide Inlet 212 236 248 1004 1006



63073 Valve Inlet 165 265 575 212 236 248 45 Degree Angle AD4.212 A4.236 A4.248 285 290 390 375 390T 2680 3650



63107 Valve Exhaust 165 265 575 212 236 248



63104 Valve Inlet 390T 398 AT4.236 30 Degree Angle



37762703 Thermostat Body 165 185
Gasket= 36853514

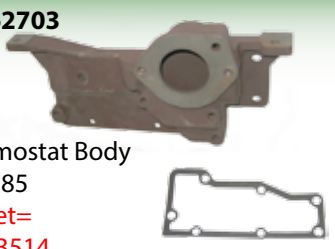

37765651 Thermostat Housing 165 168 175 178 185
Gasket= 36862151



62564 Cap Thermostat Body Long
Gasket= 36862151



2485666 Thermostat



3621F005 Cylinder Head Back Plate 212 248



63012 Gasket Cylinder Head Back Plate 212 248



899717 Oil Pressure Pipe 165



212/236/248 Cylinder Head Studs

31434307 Push Rod 212 236 248



32166339 103mm



32166338 120mm



32166337 140mm



Turbo Parts

2674355R



Turbocharger 2680 2685
T6354.4 & SC

6343

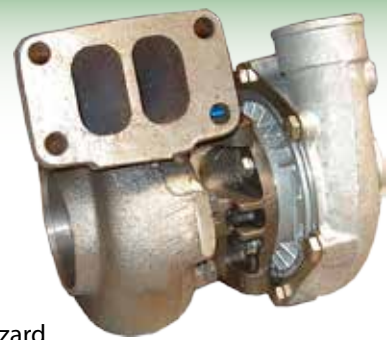

Turbocharger Blizzard

61657



Turbocharger Pipe
390 398



61660
Turbocharger
Sleeve 390 398

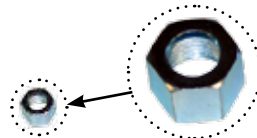

61659
Turbocharger Pressure
Pipe Nut 390T/398

Turbo Charger Gaskets

2094



Gasket Ford 7610
Turbo

6631



Turbocharger Gasket
698T

61658



Turbocharger Gasket
390 398

6354.4 Engine Parts

ZZ50008



Engine Block
T6354.4

ZZ90013



T4.236/6354.4
Turbo Con Rod

6569



Engine Oil Cooler Element O
Ring 6.354.4

Oil Pumps

41314067

Oil Pump 6.354

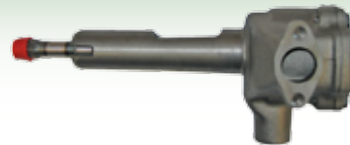

Relief Valves

41371114

Relief Valve 6354
Standard RH



41425608

Injector Pump Bear-
ing 6354.4



2415504

Seal Auxiliary Shaft
6354.4
23 x 35 , 7/46 x 10



1. **32417134** Core Plug 6354.4 - 8mm
2. **32417133** Core Plug 6354.4 - 6mm
3. **32417115** Core Plug 6354.4 - 10mm



32417156

Frost Plug 399 - 21mm



Phaser Engine Parts

3773K004



Filter Head Phaser 4 Bolts
Gasket = 62673



62672



Oil Filter Head
4245 4255 4265
4260 4270
Gasket = 62734



4133L054



Thermostat Housing
Phaser Engine Perkins

63418

Gasket For Thermostat
Housing Perkins Engine



4133L032



Thermostat Housing Top
Phaser Engine

63417

O Ring For Thermostat
Housing Perkins Engine

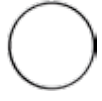

61247

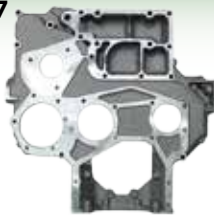

Timing Cover Phaser
Inner Aluminium

61243



Flywheel 399 Phaser
13" 4260 4270

61252



Flywheel 8110 8120
8210 8220

62928



Flywheel 3050

63009

Crankshaft 4235 4245
4255 6130 6140 6150
3350 3355 4345 4355
6235 6245 6255 4265
4365 6265 1004.4T
Blue 1004.40 Green
1004.40TW



63010

Crankshaft 5465 6465
6475 6480 7465 7475
7480 1106C - E60TA
6.354 Phaser



62609

Rocker Shaft Phaser
4 Cylinder



31162121

Ring Gear Phaser 126
Teeth 1200 1250



61956

Rocker Shaft Pipe 3000
6100 6200 8100 8200
also 399



61954

Cooler Pipe
6180/90/8110/20/30



61242



Side Plate Gasket
Phaser 6 Cylinder

62136

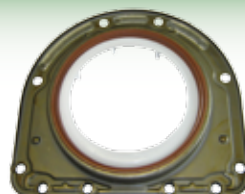

Seal Housing Phaser 4200
4300 6400 Complete

62697



Seal Complete Lip Seal &
Housing Phaser 1100
54 s / 64 s McCormick / Landini

1100'S Engine Parts 4 Cylinder

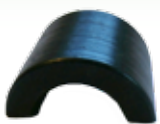
<p>63081</p>  <p>Piston & Ring Set 1104C</p>	<p>63078</p>  <p>Piston 20 Thou Oversize 1104C 3445 3455 5445 5455 5460 6445 6455 6460 6470</p>	<p>63077</p>  <p>Piston 40 Thou Oversize 1104C 3445 3455 5445 5455 5460 6445 6455 6460 6470</p>	<p>63079</p>  <p>Piston & Ring Set 1104C-44T 3445 3455 5445 5455 5460 6445 6455 6460 6470</p>
<p>63080</p>  <p>Ring Set 1104C</p>		<p>63076</p>  <p>Ring Set 1104C-44T 3445 3455 5445 5455 5460 6445 6455 6460 6470</p>	
<p>63126</p>  <p>Conrod 1104C 1106C</p>	<p>63100</p>  <p>Valve Inlet Phaser 1004T 1006T 45 Degree Angle 3635 3645 3655 4245 4255 4265</p>	<p>63102</p>  <p>Valve Inlet Phaser 1004.4 1006.6 45 Degree Angle 4225 4235 4240 4260 4270</p>	<p>62702</p>  <p>Head Gasket 1104 3 Cylinder</p>
<p>63113</p>  <p>Inlet / Exhaust Guide 1104C Inlet Guide 1106C</p>	<p>63097</p>  <p>Valve Guide Exhaust 212 236 248 1004 1006</p>	<p>63098</p>  <p>Valve Guide Inlet 212 236 248 1004 1006</p>	
<p>4132F071</p>  <p>Oil Pump 1104C 3445 3455 5445 5455 5460 6445 6455 6460 6470</p>	<p>63117</p>  <p>Valve Spring 1104C 3445 3455 5445 5455 5460 6445 6455 6460 6470</p>	<p>63092</p>  <p>Collet 212 236 248 1004 1006</p>	<p>63118</p>  <p>Cotter 1104C 1106C 3435 5425 5435 3445 3455 5445 5455 5460 6445 3445 3455 5445 5455 5460 6445 6455 6460 6470</p>
<p>63082</p>  <p>Conrod Bush 1104C 1106C 3435 5425 5435 3445 3455 5445 5455 5460 6445 3445 3455 5445 5455 5460 6445 6455 6460 6470</p>	<p>63093</p>  <p>Valve Spring 1004 1006</p>		

Conrod Bearings 1104C

Part	Description	Models
63087	Standard	
63086	10 Thou 1104C	3435 5425 5435 3445 3455 5445 5455 5460
63085	20 Thou 1104C	6445 3435 5425 5435
63084	30 Thou 1104C	3445 3455 5445 5455 5460 6445 6460 6470



Main End Bearings 1104C

Part	Description	Models
63091	Standard	
63090	10 Thou 1104C	3435 5425 5435 3445 3455 5445 5455 5460 6445
63089	20 Thou 1104C	6460 6470 3435 5425 5435
63088	30 Thou 1104C	3445 3455 5445 5455 5460 6445

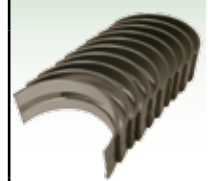

1100'S Engine Parts 6 Cylinder

63111

Finished Liner
1106C-E60TA
5465 6465 6475 6480 7465
7475 7480



63112

Liner 1106C-E60TA Semi-Fin-
ished 5465 6465 6475 6480
7465 7475 7480



63126

Conrod 1104C
1106C



63100

Valve Inlet Phaser
1004T 1006T
45 Degree Angle
3635 3645 3655 4245
4255 4265



63102

Valve Inlet Phaser
1004.4 1006.6
45 Degree Angle
4225 4235 4240
4260 4270



63113

Inlet / Exhaust
Guide 1104C
Inlet Guide
1106C



63097

Valve Guide
Exhaust 212
236 248 1004 1006



63098

Valve Guide
Inlet 212 236 248
1004 1006



63114

Exhaust Guide
1106C 5465 6465
6475 6480 7465
7475 7480



63118

Cotter 1104C 1106C 3435
5425 5435 3445 3455 5445
5455 5460 6445 3445 3455
5445 5455 5460 6445 6455
6460 6470



63092

Collet 212 236 248
1004 1006



63123

Exhaust Valve Seal
1106C
5465 6465 6475 6480
7465 7475 7480



63121

Inlet Valve Seal 1106C
5465 6465 6475 6480
7465 7475 7480



63082

Conrod Bush 1104C 1106C
3435 5425 5435 3445 3455 5445
5455 5460 6445
3445 3455 5445 5455 5460 6445
6455 6460 6470



63093

Valve Spring
1004 1006



63119

Valve Spring 1106C 5465
6465 6475 6480 7465 7475
7480



Oil Pumps & Related Parts

41314078

35/135 Oil Pump



41314164

Oil Pump 203



41314054

Oil Pump 212



62706

Gear Oil Pump 155 158
165 260 65 765 865
A4.192 A4.203 AD4.203



2722A206

Oil Pump Idler Gear
C Clip 212

996717

Relief Valve 212



4132F067

Oil Pump 1106C 5465
6465 6475 6480 7465
7475 7480



4132F051

Oil Pump Assembly 4
Cylinder - Non Turbo



4132F056

Oil Pump Assembly 4
Cylinder - Turbo



4132F043

Oil Pump
Assembly
6 Cylinder -
Non Turbo



4132F057

Oil Pump
Assembly
6 Cylinder -
Turbo



63023

Oil Pump
Perkins
P6



Balancer Parts

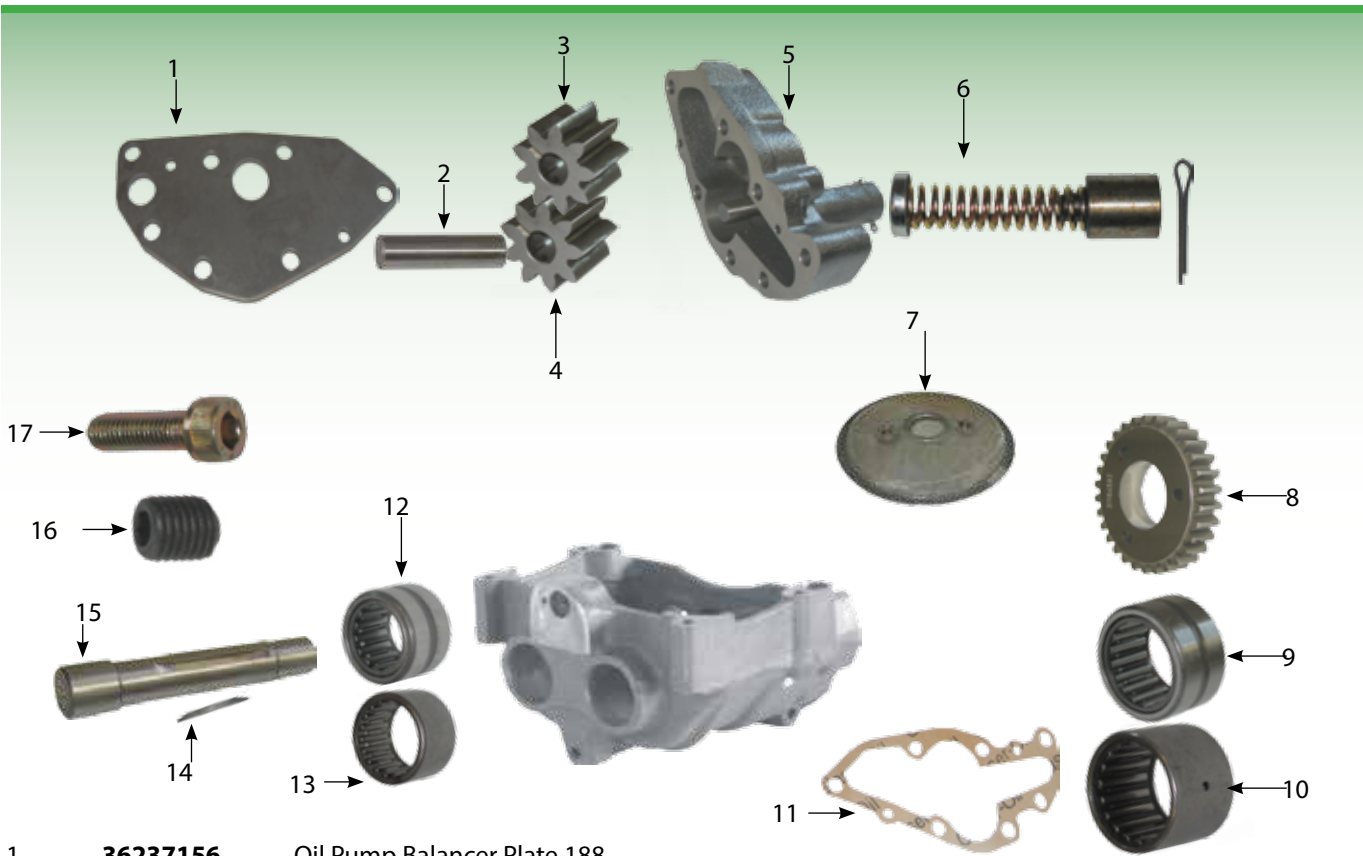

- | | | |
|-----|-----------------|--------------------------------|
| 1. | 36237156 | Oil Pump Balancer Plate 188 |
| 2. | 32731127 | Balancer Shaft 168 178 188 |
| 3. | 31165531 | Gear 236 248 Splined |
| 4. | 31165461 | Balancer Oil Pump Plain Gear |
| 5. | 37714234 | Oil Pump Body 236 248 |
| 6. | 61249 | Balancer Plunger Kit 236 248 |
| 7. | 37725443 | Oil Pump Strainer 100 200 500 |
| 8. | 31164582 | Balancer Gear |
| 9. | 2557181 | Balancer Unit Bearing New Type |
| 10. | 31165461 | Plain Gear |
| 11. | 36866722 | Oil Pump Gasket 236 248 |
| 12. | 2557182 | Balancer Unit Bearing New Type |
| 13. | 2558375 | Balancer Unit Bearing Old Type |
| 14. | 2576675 | Key |
| 15. | 32731127 | Shaft |
| 16. | 2171225 | Grub Screw |
| 17. | 2172513 | Allen Screw |

31171741

Balancer Unit Gear



41733082

Balancer 248 - Old Type - 4 Stud



2378

Repair Kit Balancer - 11 Part Kit



61249

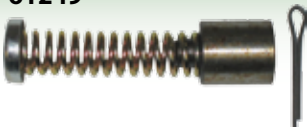

Balancer Plunger Kit
236/248

32523404



Balancer Idler Gear Stud

31171272



Balancer Shaft -
Old Type

Balancer Parts 6 Bolt Type

4111K051

Balancer Mid Mounted New
Type - 6 Stud

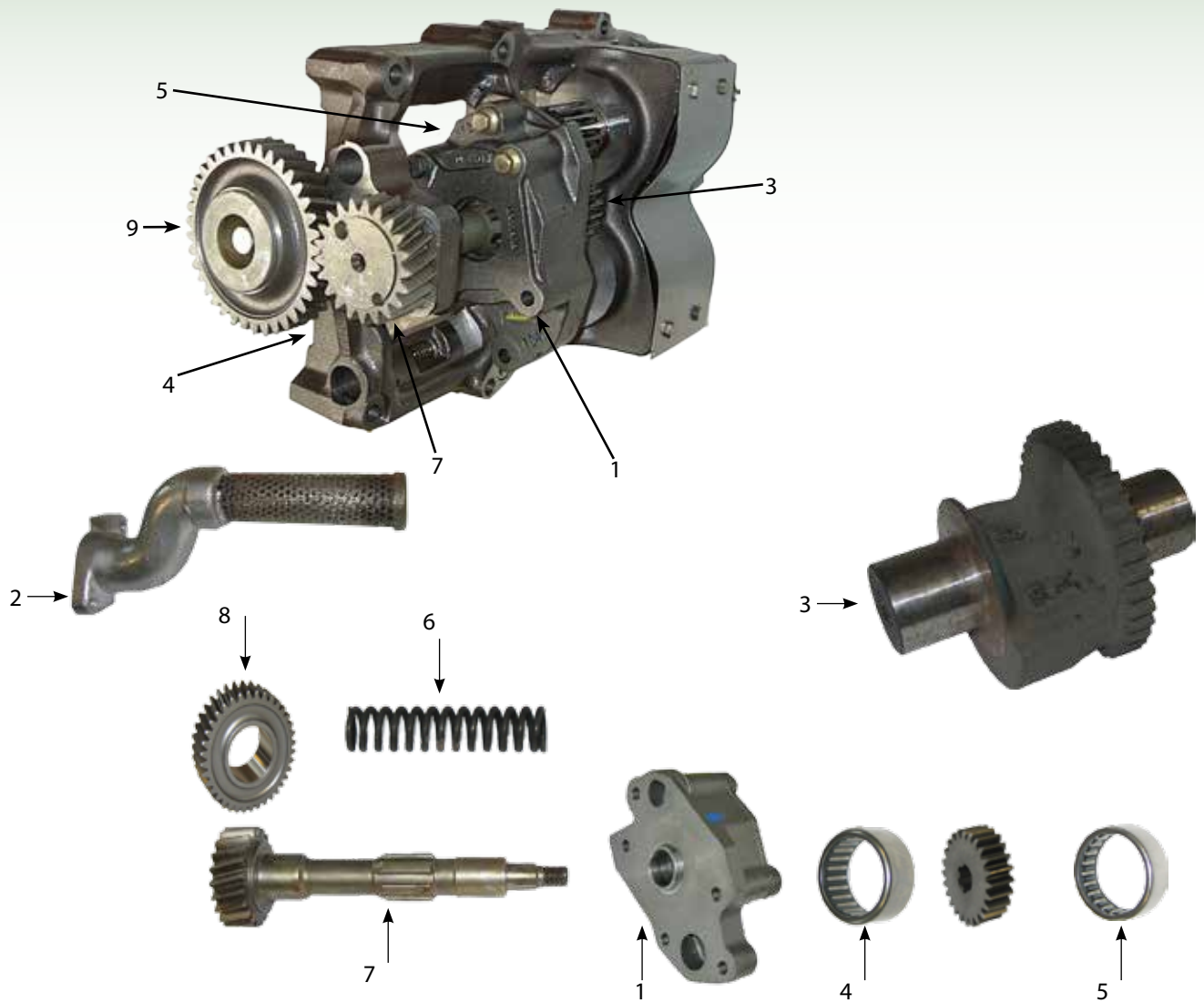

- 1. **4132F041** Oil Pump New Mid Mounted Balancer
- 2. **6923** Mid Mounted Balancer Screen
- 3. **3116K004** Weight New Type Balancer
- 4. **2551A014** Balancer Bearing Mid Mounted
- 5. **2551A009** Balancer Bearing 390 Mid Mounted
- 6. **3174D005** Balancer Spring T4236 Mid Mounted
- 7. **3117V003** Balancer Shaft
- 8. **3117C071** Balancer Gear 265 285

Fuel Tank Parts

6946



Fuel Tank 135 13"
Sender Unit=897403
Cap=8002

61517



Fuel Tank 240
Cap=1876534

62619



Fuel Tank 35 35X

160486

Fuel Tank Stud Set
135 240



62978

Fuel Tank Cap With Lock
To Suit 6946T Only



61985



Fuel Tank 188
Cap=8002
Sender Unit=897389
Tank Mounting=883622/3
Fuel Tap=898580

62017



Fuel Tank 165 168
Fuel Cap=8002

62557

Fuel Tank Support
Front



62556

Fuel Tank
Support Rear



883622

Fuel Tank Support
Rear WRM2188



62929

Tank Strap 165 Front



62930

Tank Strap 165 Rear

3166

Fuel Tank 265 275
285 290
Cap=1876534

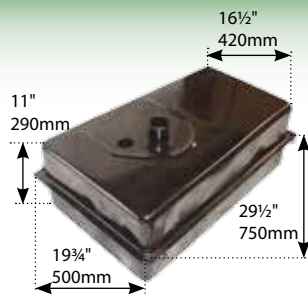

62555

Lock Fuel Tank 165 285 290



61411

Fuel Tank 20 TVO
Single c/o Cap
Petrol Only
Fuel Cap=61290



62415

Fuel Tank 20D



Fuel Cap=61290

61288

Fuel Tank 20 TVO - Double
Fuel Cap=61290



62129

Seal Kit For TE 20 Fuel Tap/
Glass Bowl

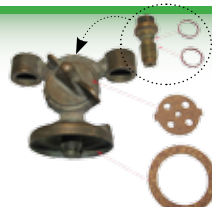

1850167

Fuel Assembly
Screw 20 TEF 35



Fuel Caps

61290



Fuel Tank Cap
20 TVO

8002



Fuel Tank Cap Metal
100 Series David
Brown

1876534



Fuel Tank Cap 500 690

61711



Fuel Tank Cap 300's
Lockable Diesel

6021G



Fuel Tank Cap 300S -
Non Lockable

59840



Fuel Tank Cap
43/54/64/74/84
Lockable

59436



Fuel Tank Cap
43/54/64/74/84
No Lock

62147



Fuel Tank Cap 4225 - 4270
8210 - 8260

61141



Fuel Tank Cap 3000 6100 8100

62470



Fuel Tank Cap Lockable
3000 3600 8120 - 60

600'S Fuel Tank Pipes

6198



Hose 698 698T 699
Tank to Tank RH

6173



Fuel Tank Hose
690 698 699 LH

6199



Hose 675 699
Tank Filler

6181



Fuel Tank Pipe 690
RH & LH

883623



Tank Mounting 165 168
185 188 265 290 -24.7mm

883622

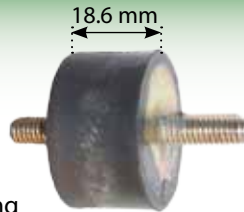

Tank Mounting
165 188 - 18.6mm

Fuel Tank Mounting

Fuel Gauges

894844



Gauge Fuel 165 168
175 178 185 188

6747



Gauge 300 Fuel &
Temperature

1877717



Gauge 200 & 500
Fuel

Fuel Taps

898580



Fuel Tap 165 188
Brass Tap

898580P



Fuel Tap 165 188
Plastic

1694985P



Fuel Tap 200 300
Plastic Fits 240 265
290 390 390T 398

1694985

Fuel Tap 200 300
Brass



6022



Suction Pipe
390 Fuel Tank

1851654

Fuel Tap Strainer



1851653

Fuel Tap 35 65 Brass

1851654

Fuel Tap Strainer



898540

Fuel Tap 135 Vertical

Fuel Senders

<p>897403 Fuel Sender 135 - Old Type</p> 	<p>1861789</p>  <p>Fuel Sender 135 148 (New Type)</p>	<p>897389</p>  <p>Fuel Sender Unit 165 188</p>	<p>61617</p>  <p>Fuel Sender Unit 240 5 Hole</p>	
<p>6376</p>  <p>Fuel Sender Unit 290</p>	<p>1613684</p>  <p>Fuel Sender 565</p>	<p>62160</p>  <p>Fuel Sender Unit 240 6 Hole</p>	<p>1613002</p>  <p>Fuel Sender Unit 575 590 592 595</p>	<p>1678518</p>  <p>Fuel Sender Unit 690</p>
<p>6023</p>  <p>Fuel Sender Unit 390's Side Entry Fuel Tap To Tank Pipe=6022</p>	<p>6494</p>  <p>Fuel Sender 399 New Type 30" Long</p>	<p>61463</p>  <p>Fuel Sender 390 New Type Low Profile 27" Long</p>	<p>61619</p>  <p>Fuel Sender Unit 3050</p>	

TEF20

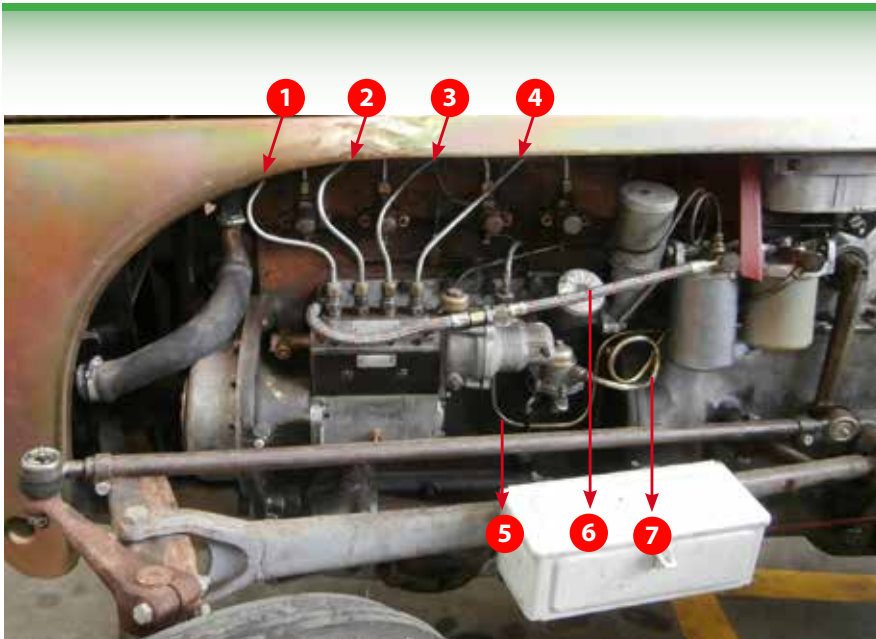

62835

Tank Kigass
TEF20



62974

Auxiliary
Tank 20



62970

Bracket for
Auxiliary
Tank 20



62420

Pipe TEF 20 Air Intake
to Injector Pump



62427

Pipe TEF 20 Leak off to Tank



62422

Pipe TE 20 Diesel Tank to Lift Pump
Also Filter to Lift Pump



42105

Fuel Pipe to
Carburetor
TED20 TVO
20 Petrol



1 62040



Injector Pipe
TEF20 No 1

2 62041



Injector Pipe
TEF20 No 2

3 62042



Injector Pipe
TEF20 No 3

4 62043



Injector Pipe
TEF20 No 4

5 62920



Pipe 20D
Tap to Fuel
Lift Pump
After '53 c/o
Fuel Pump

6 62423



Pipe 20D
Fuel Filter Head
c/o Banjo Bolt

7 62426



Pipe 20D
Auxiliary
to Main Tank

62849

Injector 20D - SET 4



TEF20

62421



Pipe 20D Leak Off

62425



Pipe 20D Kigass To Manifold Heater Plug

62921



Fuel Pipe 20D Filter to Injector Pump After '53 c/o Fuel Pump

62919



Fuel Pipe 20D Fuel Lift Pump to Filter After '53 c/o Fuel Pump

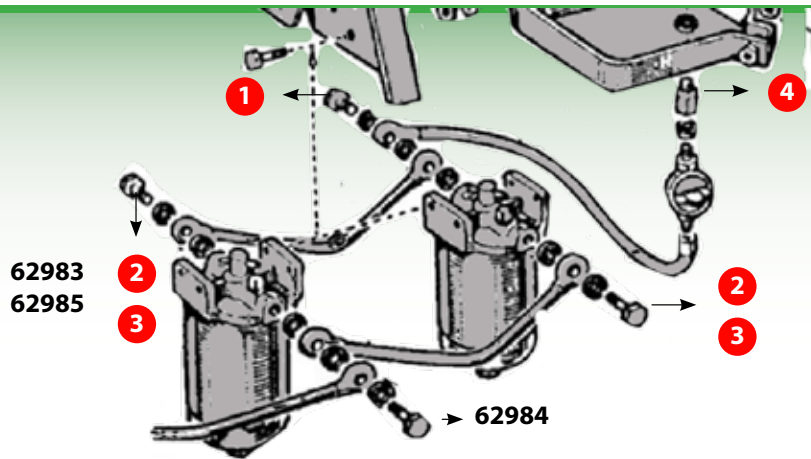

1 62984
Banjo Fitting 20D Fuel Filter Pre 53



3 62985
Banjo Fitting 20D Fuel Filter 2 pieces on Pre 57 4 pieces of Late Type



2 62983
Banjo Fitting 20D Fuel Filter 2 pieces on pre 57 4 pieces on Late Type



4 62966
Adaptor for Late Type Fuel Tap 20

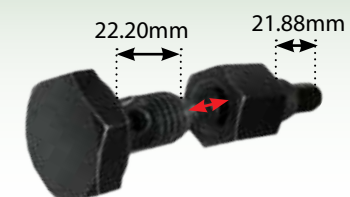
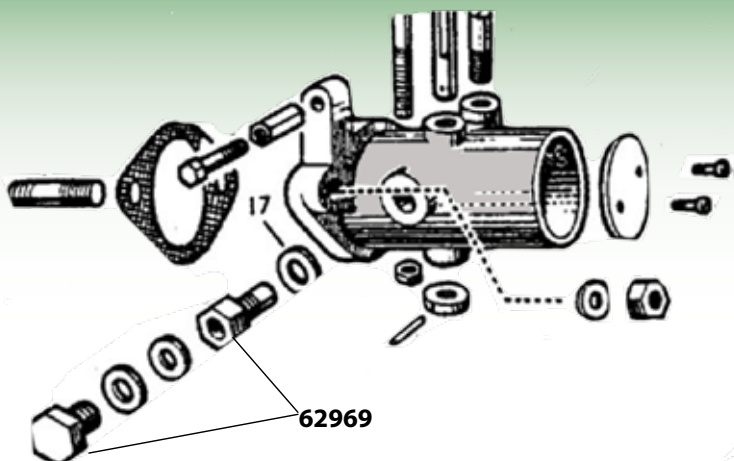

62969
Banjo and Adaptor from 20D Venturi Assy

35 Fuel Lines



- 1. **890971** Fuel Filter Assembly 35X Fordson Major Dexta
Fuel Filter=32327
- 2. **888484** Pipe 35 135 Filter to Filter
- 3. **991045** Fuel Filter Assembly Single
Fuel Filter=1782 / 1782B
- 4.61702 Fuel Filter Head Banjo Bolt

135 Fuel Lines

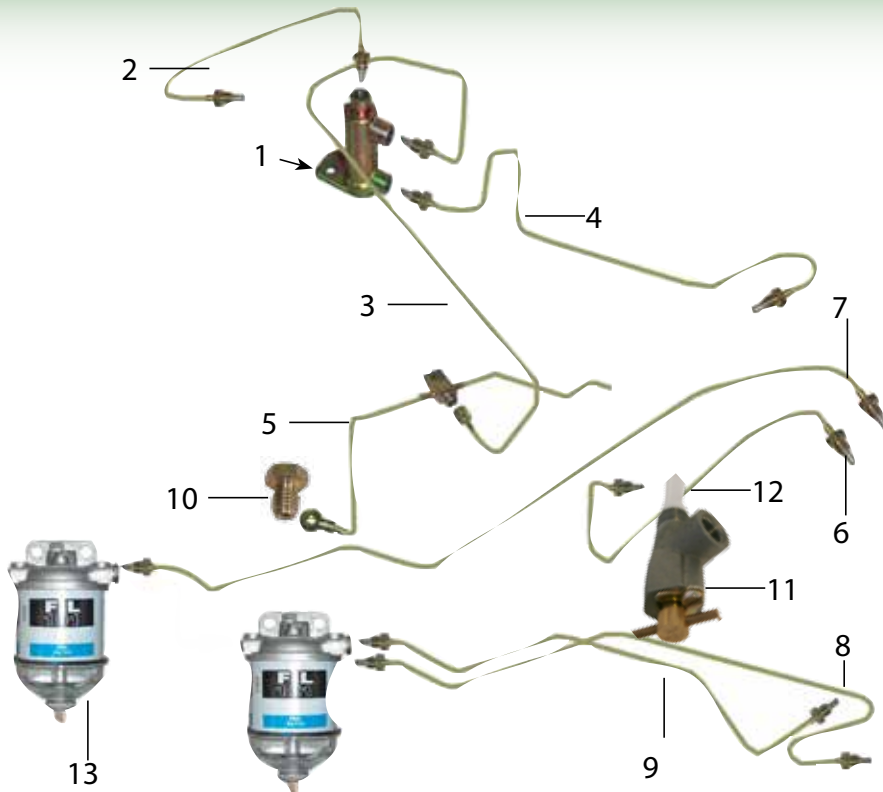

- 1. **891969** Auxiliary Tank 135 165 185 35 35X 65 Reservoir Tank Perkins A4.192 A4.203 AD4.203 A4.212 A4.236
- 2. **1831401** Pipe 135 Auxillary Tank to Tank
- 3. **1831404** Pipe 135 Auxillary Tank Leak Off
- 4. **1831405** Pipe 135 Auxillary Tank to Heater
- 5. **1831408** Pipe 135 Leak off to Injector
- 6. **883712** Fuel Pipe 135 148 152 240 265 Flexy Tank To Lift Pump
- 7. **1831403** Pipe 135 Lift Pump to Filter
- 8. **1831402** Pipe 135 Long Injector Pump to Filter
- 9. **1831406** Pipe 135 Filter to Injector Pump Short
- 10. **51224** Fuel Filter Bolt Plug
- 11. **898540** Fuel Tap 135 Vertical
- 12. **1851654** Fuel Tap Strainer
- 13. **991045** Fuel Filter Assembly Single Imperial **Fuel Filter=1782 / 1782B**

35/35X Up To Serial No

35/35X From Serial No

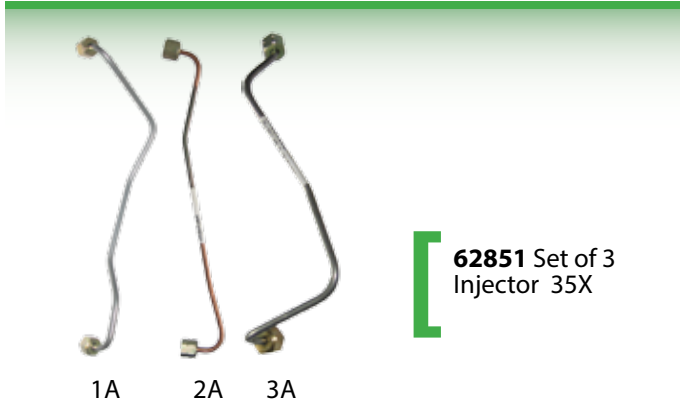

62851 Set of 3
Injector 35X

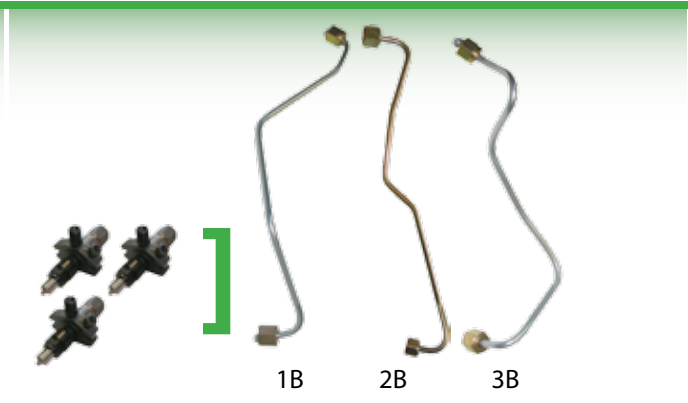

- 1A. **35354163** Injector Pipe 35 No 1 - up to Serial No
- 2A. **35354164** Injector Pipe 35 35X No 2 Up To Engine Number
- 3A. **35354165** Injector Pipe 35 35X No 3 Up To Engine No

- 1B. **35355265** Injector Pipe 35 35X No 1 From Engine No
- 2B. **35355266** Injector Pipe 35 35X No 2 From Engine No
- 3B. **35354237** Injector Pipe 35 35X No 3 From Engine No

35's 4 Cylinder

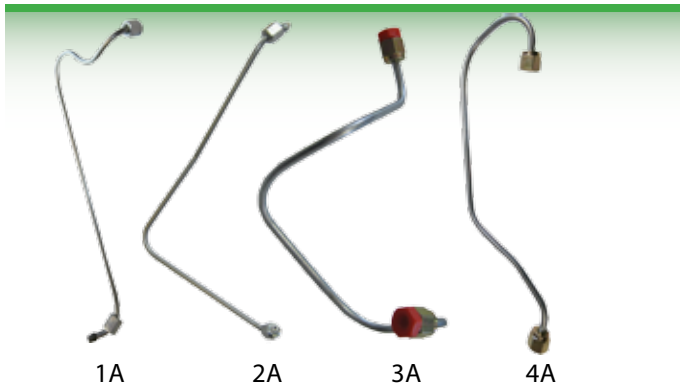

- 1A. **62915** Injector Pipe 1 35 4 Cylinder
- 2A. **62904** Injector Pipe 2 35 4 Cylinder
- 3A. **62917** Injector Pipe 3 35 4 Cylinder
- 4A. **62918** Injector Pipe 4 35 4 Cylinder

62850 Set of 4
Injector 35 4 Cylinder



827257



Leak off Pipe 35 4
Cylinder

62424



Pipe 35 4 Cylinder Filter to
Injector Pump

62914



Fuel Pipe 35 4 Cyl Leak Off Rail
to Fuel Tank

41262008



Pipe Assembly 35 - Leak Off Pipe
Fitting Kit is **62696**

62696



Fitting Kit Pipe Assembly
35 - Leak Off Pipe
For **41262008** Pipe

135 - Late Type

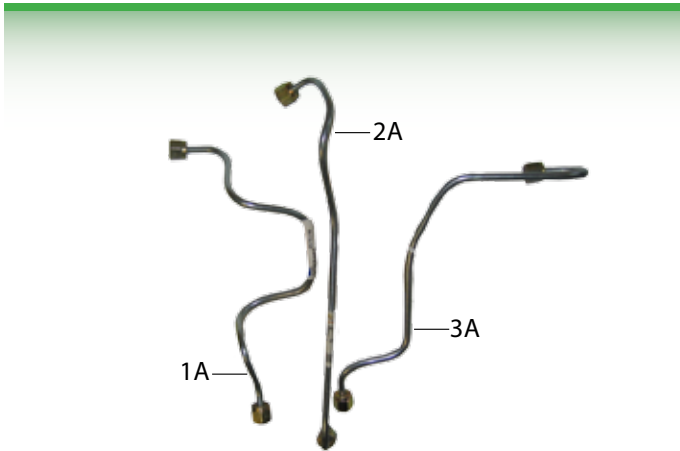

- 1A. **35342004** - Injector Pipe 135 No 1 Late Type
- 2A. **35342005** - Injector Pipe 135 No 2
- 3A. **35342006** - Injector Pipe 135 No 3

62450 Set of 3
Injector 135 AD3.152
Nozzle=62682

135 - Early Type

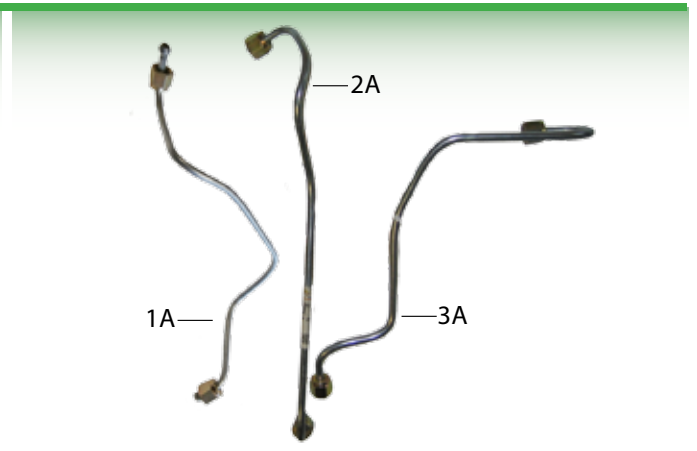

- 1A. **62922** - Injector Pipe 1 135 Early Type
- 2A. **35342005** - No. 2 135 Injector Pipe
- 3A. **35342006** - No. 3 135 Injector Pipe

230/240 -New type

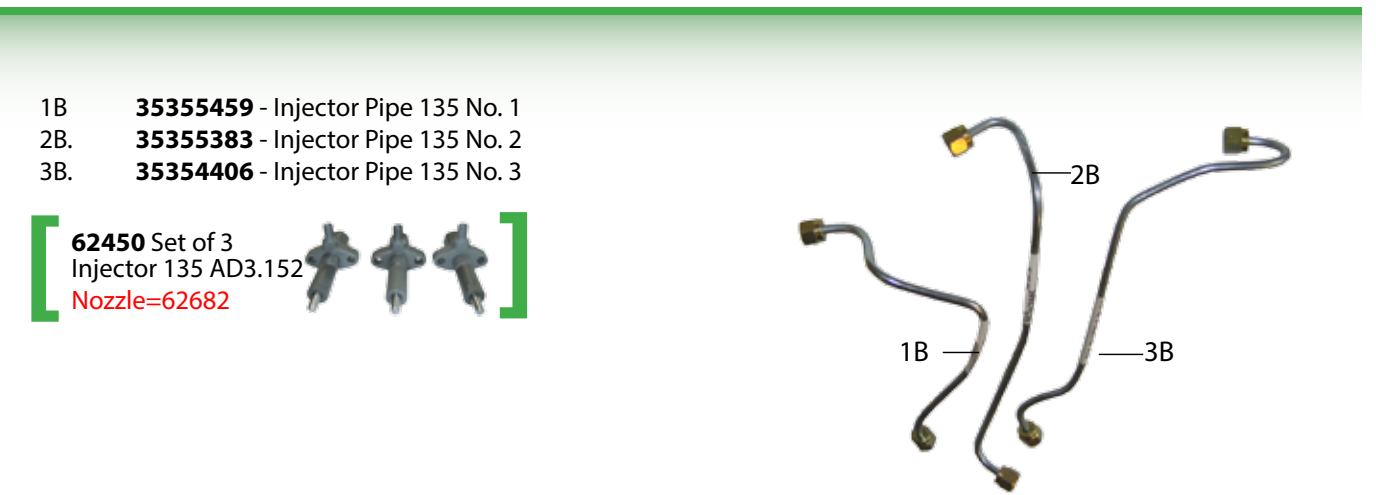

- 1B. **35355459** - Injector Pipe 135 No. 1
- 2B. **35355383** - Injector Pipe 135 No. 2
- 3B. **35354406** - Injector Pipe 135 No. 3

62450 Set of 3
Injector 135 AD3.152
Nozzle=62682

Leak Pipe

990727

Leak Off Pipe
135 Top





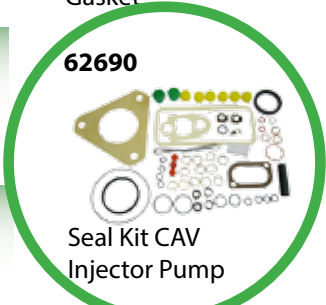
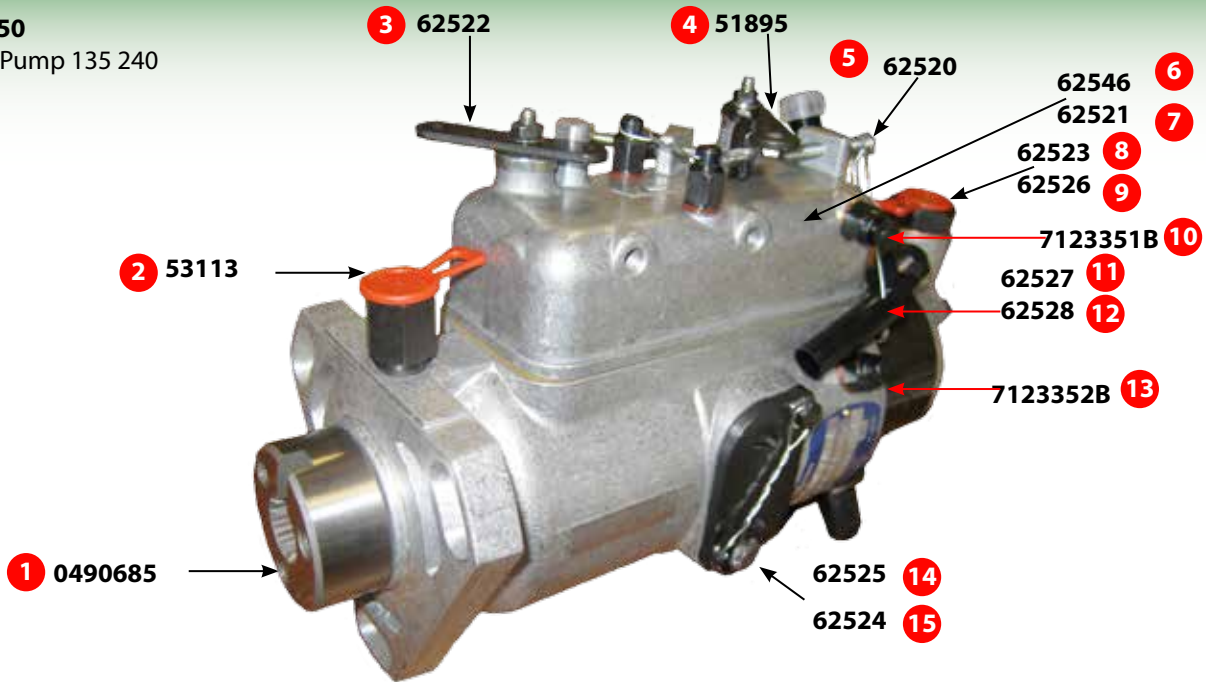

62450 Set of 3
Injector 135 AD3.152
Nozzle=62682

135 240 Injector Pump

3230F350
Injector Pump 135 240









Delphi Injector Pump Parts

<p>3240F011 Injector Pump FE35 23C</p> 	<p>3230F030 Injector Pump 35 - 3 Cylinder</p> 	<p>62354 Injector Pump 165 - 203 Engine (Old Engine)</p> 	<p>3241F360 Injector Pump 212 236 248 4 Cylinder</p> 
---	--	--	---



62690
Seal Kit CAV
Injector Pump

<p>62998 Injector Pump 390T 398 3065 3070</p> 	 <p>53267 53268 53266/ 53269</p>	<p>53267 Banjo Injector Pump Outlet</p>  <p>53266 Fuel Line Connector Injector Pump</p> 	<p>53268 Washer Injector Pump</p>  <p>53269 Fuel Line Connector Right Angle Injector</p> 
---	---	---	--

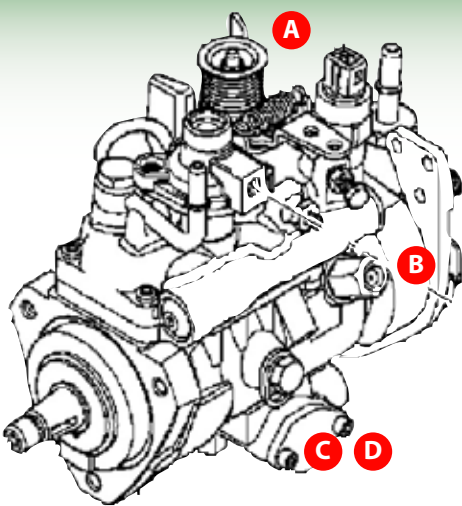

A



62727
Solenoid 12V
Diesel Stop
42s 54s Plug In
Type

B



62725
Valve for Delphi Injector
Pump 42s 54s

C



62726
Diaphragm Kit Delphi
Injector Pump 42s 54s

D



59333
Diaphragm Kit Delphi
Injector Pump 4200 5400

Solenoid Diesel Stops

<p>1976</p>  <p>Solenoid 12v Diesel Stop BOSCH</p>	<p>2038</p>  <p>Solenoid Diesel Stop 12V CAV</p>	<p>1992</p>  <p>Solenoid Diesel Stop 12V CAV Single Nut Connection</p>	<p>7778</p>  <p>** USE 1992 ** Solenoid Diesel Stop 12V CAV</p>	<p>62727</p>  <p>12V Solenoid Diesel Stop 42s 54s Plug In Type</p>
--	--	--	--	--

Fuel Injectors

3241F360

Fuel Injectors & Parts

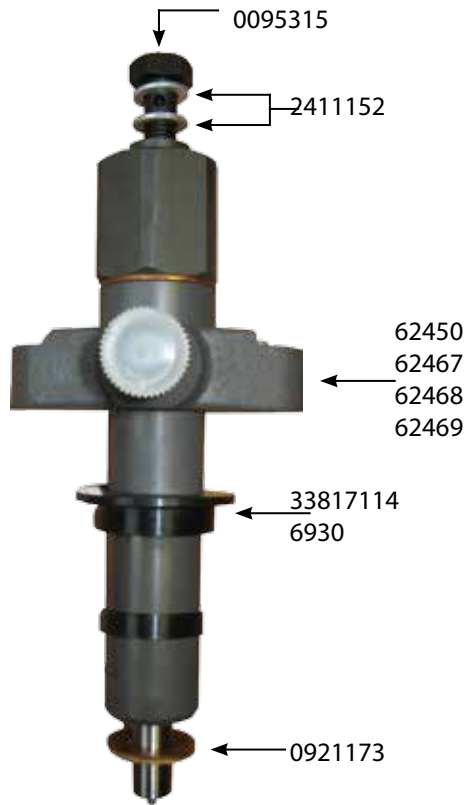

62450

Injector 135
AD3.152 SET 3
Nozzle=62682

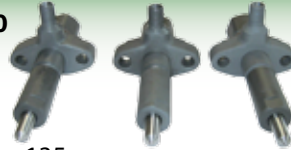

62809

Injector 65
AD4.203 Direct
- SET 4
Nozzle=62682



62467

Injector 165
4.212 - SET 4
Nozzle=62684



62468

Injector 168 4.236
- SET 4
Nozzle=62686



62469

Injector 4.248
290 390 - SET 4
Nozzle=62687



62849 Set of 4
62849S Single



Injector 20D

62850 Set of 4
62850S Single



Injector 35 4
Cylinder

62851 Set of 3
62851S Single



Injector 35X

0095315



Injector
Banjo Bolt

42137



Injector Banjo
Bolt Ford 10
100 1000
Series

33817114



Injector Dust
Seal

6930



Injector Dust Seal
New Type

0921173



Injector Washer
135

2411152



Washer
Injector Leak
Off Pipe PACK
OF 10

61716



Injector Washer
Kit 35 - Set of 3

Injector Nozzles

62680



Injector Nozzle FE35
Standard 23C 4 Cylinder

62681



Injector Nozzle A3.144
A3.152 A4.203 Indirect

62682



Injector Nozzle
AD3.152 AD4.203
Direct

62683



Injector Nozzle
AD3.152 AD4.203

62688



Injector Nozzle
A4.318

62684



Injector Nozzle
A4.212 Short Piston

62685



Injector Noz-
zle A4.248
BDLL150S6556 188

62686



Injector Nozzle
A4.236 Late Type

62687



Injector Nozzle
A4.248 290 390

165/188 Fuel Lines

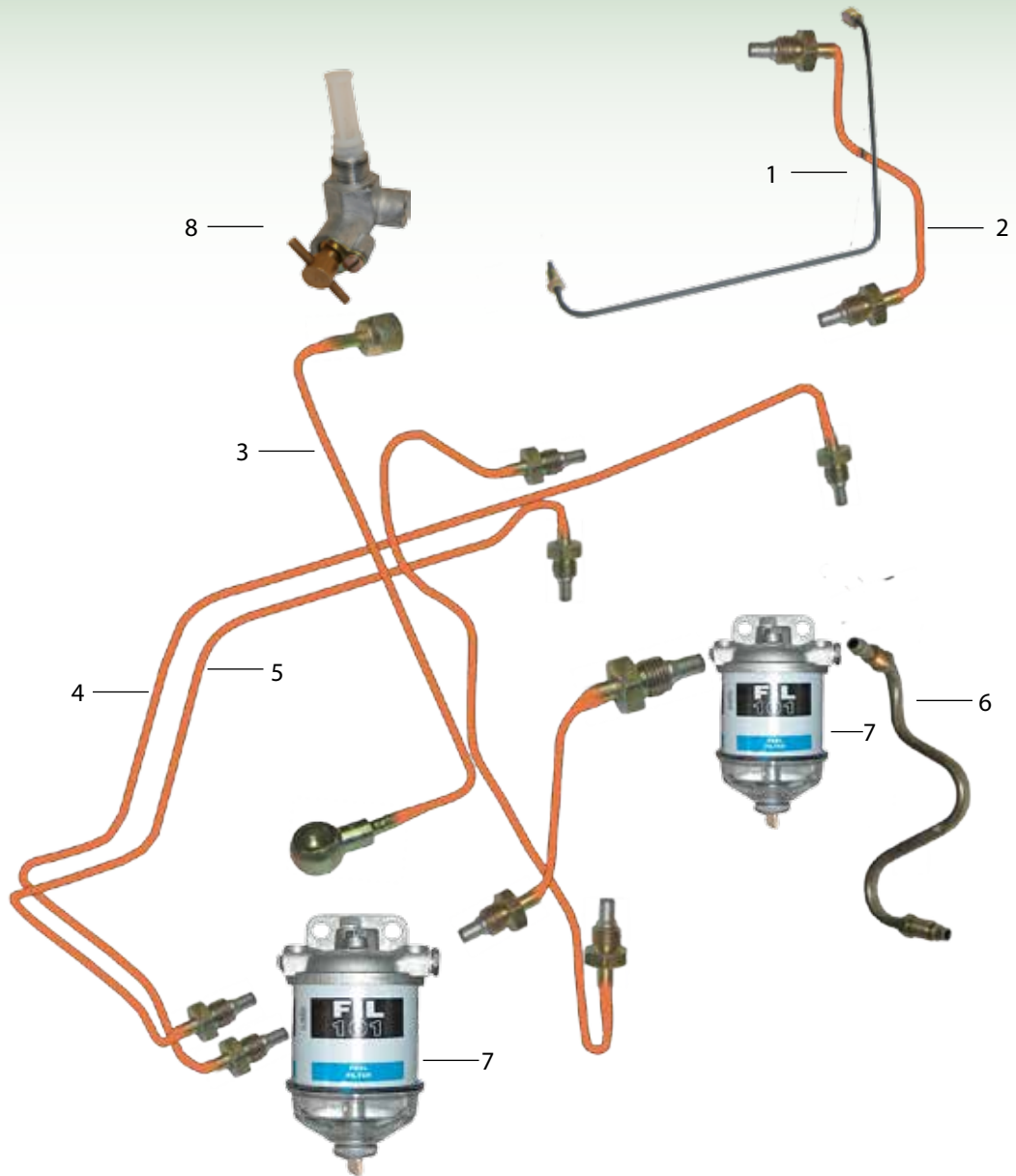

- | | | |
|----|----------------|---|
| 1. | 6604 | Pipe 165 185 Leak Off to Auxuillary Tank UpTo |
| 2. | 6587 | Pipe 165 185 Tank to Heater Plug |
| 2. | 1833917 | Pipe 165 2 Stud Lift Pump Tap to Pump |
| 3. | 1833916 | Pipe Injector Leak Off To Filter Head Pipe |
| 4. | 1833926 | Pipe 165 188 Filter to Injector Pump Long |
| 5. | 1833923 | Pipe 165 188 Filter to Injector Pump Short |
| 6. | 1832431 | Pipe 165 4 Stud Lift Pump to Filter (Tap to P |
| 7. | 991045 | Fuel Filter Assembly |
| 8. | 898580 | 165/188 Fuel Tap |

2/3/500's Fuel Lines

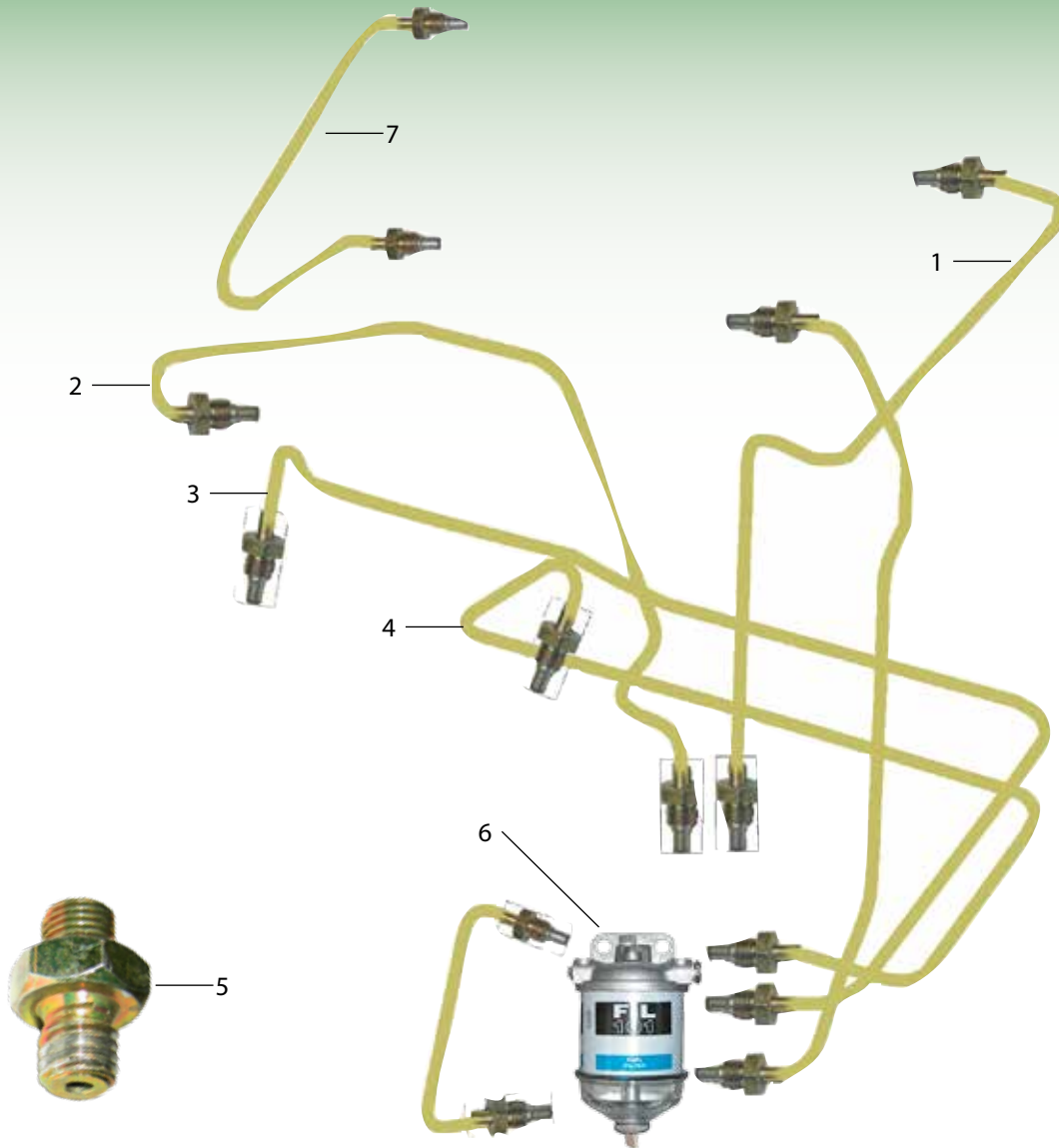

- | | | |
|----|----------------|--|
| 1. | 1876543 | Pipe 200's Leak off to Filter Head |
| 2. | 1876549 | Pipe Filter Head - Heater Plug 267 275 285 |
| 29 | | |
| 3. | 1876541 | Pipe 200 500s Injector Pump to Filter Head |
| 3. | 6584 | Pipe 675 690 Injector Pump to Fuel Filter |
| 4. | 1876539 | Pipe 200 500s Filter to Injector Pump |
| 4. | 6583 | Pipe 675 690 Injector Pump to Fuel Filter |
| 5. | 6251 | Valve 390 Non Return |
| 6. | 991045 | Single Fuel Filter Assembly |
| 7. | 1664232 | Tank Injector Leak off Pipe 265 275 |
| 7. | 6652 | Fuel Filter Pipe 290 |



62310



Clamp Fuel Pipe 100 200
300 500 600

3006



Bolt M6 x 25 Metric
Coarse Zinc & Yellow

62310K



Clamp Kit Fuel
Pipe 100 200
300 500 600

212/236/248 Injector Pipes

Injector =

- 62467 - 4.212 Set of 4
- 62468 - 4.236 Set of 4
- 62469 - 4.248 Set of 4
- 62728 - 4.248 Set of 4

5/5A —

6 —

3 — 4 —

1 — 2 —

1.	62428	Injector Pipe 390 No 1
2.	35354267	Injector Pipe 212 248 No 2
3.	35354293	Injector Pipe 212 248 No 3
4.	35355289	Injector Pipe 212 236 248 No 4
5.	0095315	Banjo Bolt
5A.	42137	Injector Banjo Bolt
6.	35587344	Leak Off Pipe

290/390 Fuel Lines

Injector = 62469 - 4.248 Set of 4

- | | | |
|----|--------------|-------------------------------|
| 1. | 62428 | Injector Pipe 390 No 1 |
| 2. | 62429 | Injector Pipe 390 No 2 |
| 3. | 62430 | Injector Pipe 390 No 3 |
| 4. | 62431 | Injector Pipe 390 No 4 |
| 5. | 62432 | Pipe 300 Series Leak Off Pipe |

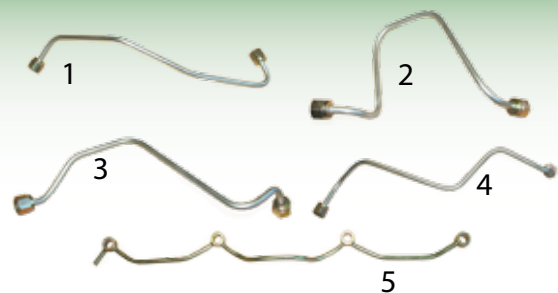

203 Leak Off Pipe

35587323



Leak Off Pipe 203

265 Fuel Pipe

62931

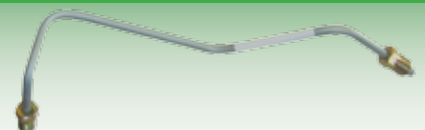





















Fuel Pipe 265 275 290 Short Injector Pump To Dual Fuel Filter Head

62559



Fuel Pipe 265 275 290 Long Injector Pump To Dual Fuel Filter Head

Fuel Lift Pumps

<p>61620</p>  <p>Fuel Lift Pump 20D 35 4 Cylinder Gasket=36862167</p>	<p>826154</p>  <p>Fuel Lift Pump 20D 35 - 4 Cylinder Gasket=36862167</p>	<p>2641406</p>  <p>Fuel Lift Pump 35 135 c/o Glass Bowl Gasket=36862167</p>	<p>2641311</p>  <p>Fuel Lift Pump 135 Gasket=36862167</p>	<p>2641712</p>  <p>Fuel Lift Pump 240 4 Stud Gasket=36851113</p>
<p>2641478</p>  <p>Fuel Lift Pump 165 188 Ford 2000 -7600 2 Stud Gasket=36862166</p>	<p>2641725</p>  <p>Fuel Lift Pump 165 188 290 4 Stud Gasket=36851113</p>	<p>26410070</p>  <p>Fuel Lift Pump Head 168 178 185 188</p>	<p>2641345</p>  <p>Fuel Lift Pump 203 65 595 c/o Glass Bowl Gasket=36862167</p>	<p>2641333</p>  <p>Fuel Lift Pump 203 595 w/o Glass Bowl Gasket=36862167</p>
<p>51484</p>  <p>Fuel Lift Pump Perkins 4/99 4.108 A4/107 Gasket=36862167</p>	<p>51566</p>  <p>Fuel Lift Pump JCB Fastrac</p>	<p>53131</p>  <p>Fuel Lift Pump Valmet Valtra Case CS</p>	<p>63028</p>  <p>Fuel Lift Pump 3445 3455 5445 5455 5460 6445</p>	
<p>2641A067</p> <p>Fuel Lift Pump Phaser 4 Cylinder 3075 4225 4235 4240 4245 4255 4265 6110 6130 6140 6150 6235 6245 6265 Gasket=36851113</p> 		<p>61998</p> <p>Fuel Lift Pump 4325 - 4355 Phaser Engine 4225 4235 4245 4255 4325 4335 4345 4355 6235 6245 6255</p> 		
<p>61999</p>  <p>Fuel Filter for Lift Pump 4325 - 4355 Phaser</p>	<p>2641729</p>  <p>Fuel Lift Pump 6354.4 Phaser 6 Cylinder</p>	<p>2641372</p>  <p>Fuel Lift Pump 6354 2 Stud</p>	<p>63167</p>  <p>Fuel Lift Pump To Suit 1000 Engine</p>	

Fuel Lift Pumps

Long

62363

Fuel Lift Pump
Electric 5400 &
Filter Housing



61491

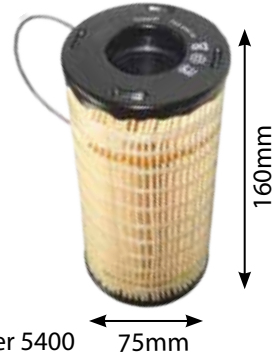

Fuel Filter 5400
6445 - 6470

62363G

Fuel Lift Pump Electric
5400 & Filter Housing
O Ring=62924

Short

62730



Fuel Lift Pump Elec-
tric McCormack V60
V65 V70
O Ring=62924
Filter=62729

62729



Fuel Filter
McCormack V60
V65 V70 V75 V80
O Ring=62924

2641A203



Fuel Lift Pump 3625
3635 3645 3655

41750



Filter Large Double In Line Type
- Pack of 2

41751



In Line
Filter-Gauze
Type - PAIR

1572



Fuel Filter In Line
Petrol

Nylon Fuel Pipe

- 3904** Fuel Line Pipe 1/4 - Sold per metre
- 3903** Fuel Line Pipe 5/16 (8mm) - Sold per Metre



Steel Fuel Pipe

- 1917** Brake Pipe 3/16" 10 Foot Length
- 1910** Fuel Pipe 1/4" Steel 10ft Length
- 1905** Pipe Fuel Line 5/16" 8mm Steel



Rubber Fuel Pipe

- 2604** Fuel Hose 3/16" - 10 Mtr. Roll
- 4525** ** USE 2604 **
- 2605** Fuel Hose 1/4" - 10 Mtr Roll
- 4526** Fuel Hose 1/4" - Per Mtr.
- 2606** Fuel Hose 5/16" - 10 Mtr. Roll
- 2607** Fuel Hose 3/8" - 10 Mtr Roll
- 4528** Fuel Hose 3/8" - Per Mtr.



S Type Fuel Pipe

Part No.	Length (cm)
890145	30
890137	50
890138	60
890140	70
890146	80
890141	90
890142	100

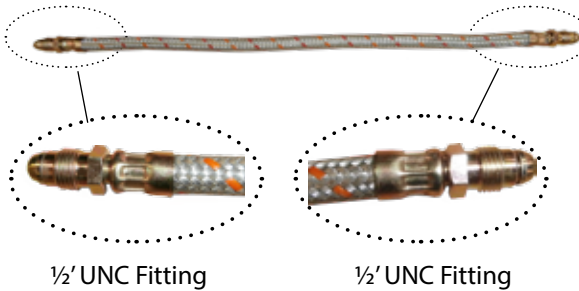

1/2' UNC Fitting

1/2' UNC Fitting

Spigot

62950

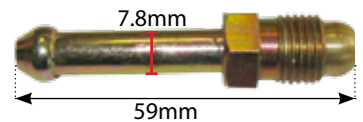

Joiner Fuel Pipe Brass Long

1924



Fuel Line Pipe Union 5/16" Male

1978



Fuel Line Pipe Union 1/4" Male

1974



3/16 Union Male Oil Pressure

1975



Heater Plug Pipe 3/16 Male

1973



Oil Pressure Pipe 3/16" Union F/M

Hose Clip

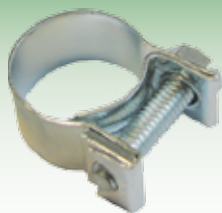

Part No.	Size mm
59659	11mm
59660	13mm
59658	14mm
59661	17mm

Fuel Pipe Joiner



Part No.	Size "
3970	3/16
3971	1/4
3972	5/16
3973	3/8

Barrel Olive



Part No.	Size "
1721	3/16
1296	1/4
1297	5/16
3430	3/8

Hand Primers

Fuel Filter Assembly

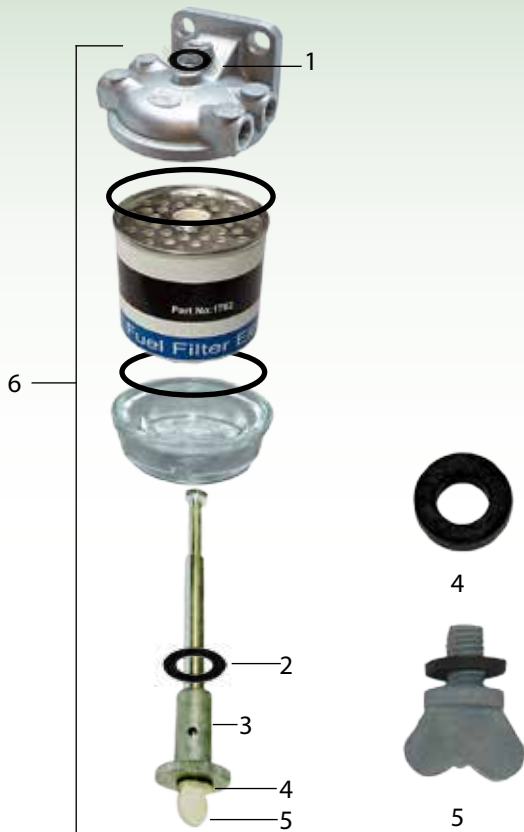

- 1. **1698** Fuel Stud Upper O Ring
- 2. **922165** Washer Under Glass Bowl
- 3. **1830702** Fuel Filter Stud Assembly
- 4. **3392** Washer for Bleed Screw
- 5. **922169** Fuel Filter Bleed Screw
- 6. **991045** Fuel Filter Assembly Single Imperial

Glass Bowls

7111429



CAV Glass Bowl *Shallow Large Hole*
Washer=922165

7111403



Deep Filter Glass Bowl
Large Hole

1049

Glass Bowl 9mm Bosch System



9mm Hole



Aluminium Bowls

1581



Filter Bowl
Aluminium Type

7111493



Fuel Filter Bowl -
Aluminium

62313











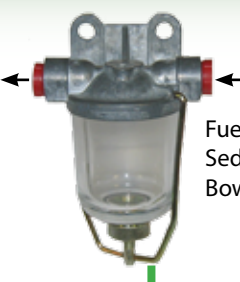
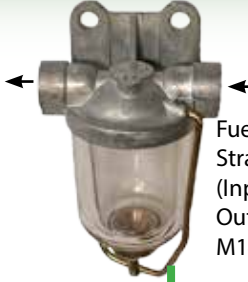











Fuel Filter Bowl Aluminium
c/o Stem & Tap

















Single Fuel Filters

Fuel Strainers

Fuel Separator

<p>51489</p>  <p>Fuel Strainer (Input/Output 1/2" - 20 UNF)</p>	<p>1028371</p>  <p>Fuel Line Sediment Bowl</p>	<p>51491</p>  <p>Fuel Strainer (Input/ Output M14 1.5)</p>	<p>3416</p>  <p>Fuel Separator Ford & Massey Ferguson</p>
<p>0490538 Seal 35 Glass Bowl</p> 		<p>0995260 Glass Bowl 35 for Lift Pump</p> 	
<p>3835 Fuel Filter Imperial Head 500's</p> 	<p>62348</p>  <p>Single Fuel Filter Assembly Complete</p>	<p>991045</p>  <p>Fuel Filter Assembly (Single) Imperial</p>	<p>43059</p>  <p>Fuel Strainer Ford 2N 8N 9N Jubilee NAA 35 35 Petrol 35X TEA20 TED20 788 Combine</p>
<p>61235 Fuel Filter Assembly 100 200 c/o Long Filter Also Fits 4200 4300 6200</p> 	<p>59062</p>  <p>Fuel Strainer TE20 TO20</p>		
<p>3760</p>  <p>Fuel Filter Assembly & Aluminium Bow</p>	<p>51492</p>  <p>Fuel Fil- ter Head & Base</p>	<p>33811114 Rubber Olive 5/16" 376524 Rubber Olive 3/16" 376525 1/4" Rubber Olive</p> 	<p>7111353</p>  <p>Imperial Head UNF</p>
<p>51224</p>  <p>Fuel Filter Bolt Plug</p>	<p>61709</p>  <p>Blanking Plug Kit For Fuel Filter Head</p>	<p>61348</p>  <p>Fuel Filter Blanking Plug KIT</p>	<p>61707</p>  <p>Fuel Filter Head Blanking Plug All Models</p>
<p>61702</p>  <p>Fuel Filter Head Banjo Bolt</p>	<p>51487</p>  <p>Fuel Filter Dual - Inlet/ Outlet M14 x 1.5</p>	<p>51572</p>  <p>Fuel Filter Twin (Inlet/ Outlet 1/2"UNF - M20</p>	<p>2656818</p>  <p>Dual Filter Head - Imperial</p>
<p>3834</p>  <p>Dual Imperial U.N.F. Head</p>			

Throttle Parts

<p>61418</p> 	<p>61419</p> 	<p>828656</p> 	<p>62168</p> 
<p>Foot Throttle Kit 35 135 - Bent Axle</p>	<p>Foot Throttle Kit 135 240 Straight Axle</p>	<p>Foot Throttle Pedal Spring</p>	<p>Foot Throttle Kit 165 185 285</p>
<p>890278</p> 	<p>897467</p> 	<p>828019</p> 	<p>63203</p> 
<p>Hand & Foot Throttle Lever 35 35X 135 148</p>	<p>Hand Throttle Lever 135 148 240 & Foot Thrott</p>	<p>Hand & Foot Throttle Bracket 35 35X 65 135</p>	<p>Foot Throttle Lever Bracket 135 240</p>
<p>1866841</p> 	<p>897635</p> 	<p>63187</p> 	
<p>Foot Throttle Bracket 135 265 290</p>	<p>Foot Throttle Rod</p>	<p>Hand Throttle Rod 135 240</p>	
<p>897545</p> 	<p>1861633</p> 	<p>897535</p> 	
<p>Plunger Shaft</p>	<p>Throttle End 35 35X 65 165 168 175 265 Also fits 275 290 550 565 575</p>	<p>Rod Throttle</p>	

Throttle Parts

61726



Hand Throttle Lever 20
TVO

61724



Hand Throttle Lever TE
20 (P3)

61730



Hand Throttle Lever
20D

61725



Hand Throttle Lever 35
3 & 4 Cylinder

61727



Hand Throttle Lever 65

61835



Hand Throttle Lever
165 175 178 Old Type

61728



Hand Throttle Lever
135 148 Old Type

61729



Hand Throttle Lever
135 148 New Type

62923



Hand Throttle Lever
135 With Spring

899023



Throttle Control Stop Rod 135

898821

Stop Rod 265 275 290 375 390



63016



Stop Rod 165 175 185 188

922270



Stop Guide Clip

63201



Pull Stop Rod Bracket
135 240

894225



Clip 135 165 240
265 285 Throttle
Large Hole

922911



Stop Rod
Clamp 135
Small Hole

2/5/600's Throttle Parts

61419



Foot Throttle Kit 135 240
Straight Axle

1876338



Hand & Foot Throttle Cross
Shaft 265 275 Also Fits
285/290

1877395



Throttle Knob 200
500

61529



Throttle Plunger 275 285 290
& Nut

61608



Hand Throttle Lever 200

1861552



Hand Throttle Lever 240 /
250

6310



Foot Throttle Spring
600's

1676662



Throttle Linkage 275 285 290
(5 Piece)

300's Throttle Cables & Parts

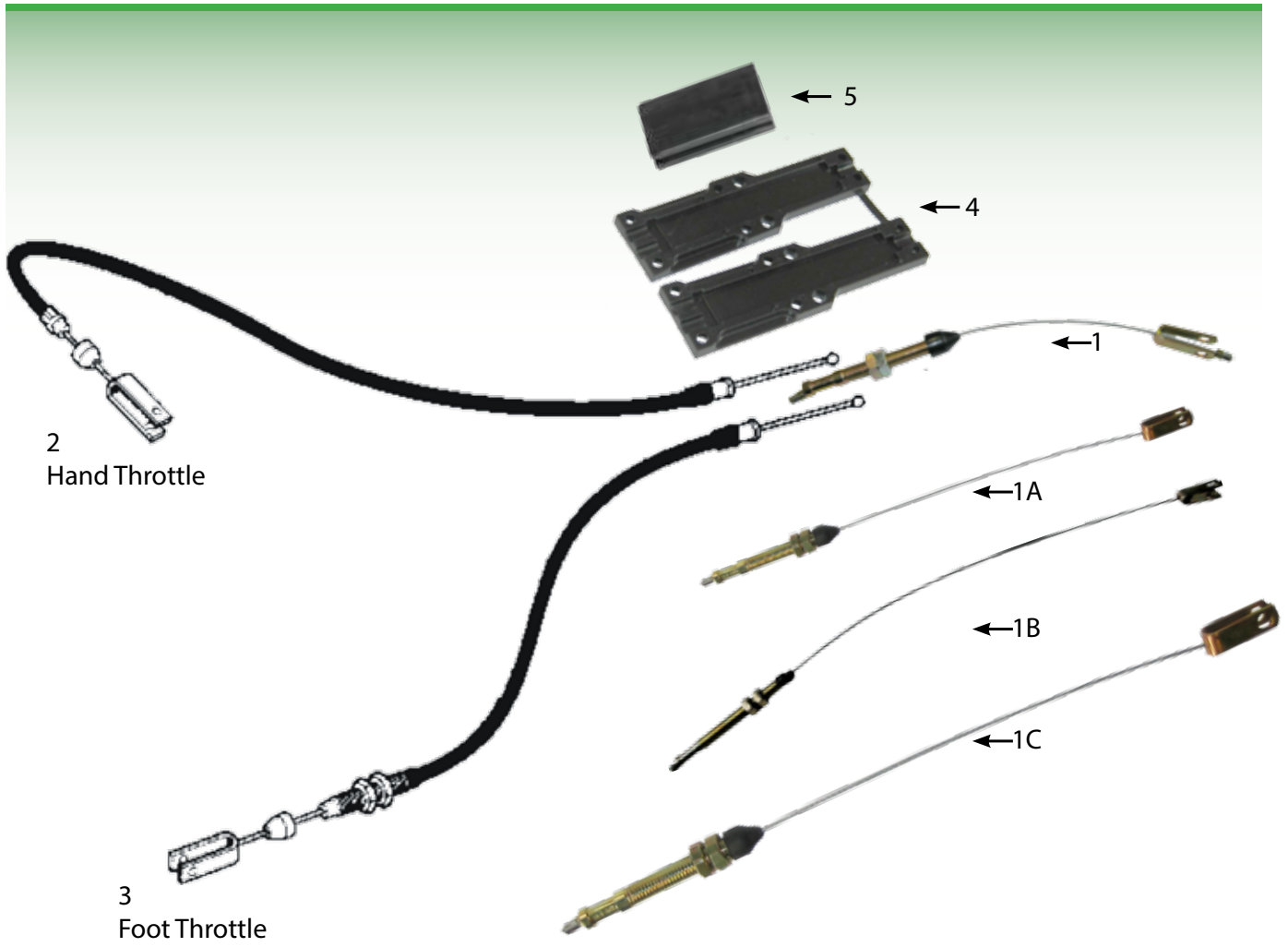

- 1. **6037** Throttle Cable 365 390 T 399 To Injector Pump **235mm**
- 1A. **6033** Throttle Cable 300 - To Injector Pump 270mm **270mm**
- 1B. **61490** Throttle Cable 399 Phaser Short 420mm long
- 1C. **6503** Throttle Cable 399 Front 6354 Engine **610mm**
- 2. **6032** Hand Throttle Cable 390 390T 399 1350mm Long **1350mm**
- 3. **6031** Foot Throttle Cable 390 390T 399 980mm Long **980mm**
- 3. **62995**Foot Throttle Cable 390 390T 399 1190mm Long **1190mm**
- 4. **6034** Housing 200 300 3000 3600 Throttle Cable
- 5. **6117** Throttle Cable Slider 300

6229
Hand Throttle Knob 300



6329
Injector Pump Throttle Return Spring



61172
Foot Throttle Spring 300



Cable End Clamps (Solderless Nipples)

51956
Cable End 1/4"
(6mm)



51957
Cable End 9/32"
(7mm)



51959
Cable End 11/32"
(9mm)



51958
Cable End Assortment
Pack of 25 1/4" x 3/8",
11/32" x 1/2", 9/32" x 1/2"



Throttle Cables

61886 Thread Ø= 8 mm
Overall length =940 mm
Outer cable=750 mm



Hand Throttle Cable
4200 4300

6564 Thread Ø= 12 mm
Overall length =780 mm
Outer cable=500 mm



Throttle Cable 2000

61217 Thread Ø= 5 mm
Overall length =720 mm
Outer cable=600 mm



Hand Throttle Cable 3000 3100 3600
For Side Mounted Hand Throttle Only
(not dash mounted)

6178 Thread Ø= 7 mm
Overall length =1110 mm
Outer cable=940 mm



Throttle Cable 690 698
698T

6311 Thread Ø= 9 mm
Overall length =1560 mm
Outer cable=1500 mm



Foot Throttle Control
Cable 699

61218 Overall length =710 mm



Throttle Cable 3000 3100
3600 Short 205mm

62739 Thread Ø= 8 mm
Overall length =730 mm
Outer cable=570 mm



Foot Throttle Cable 5400 6400
4 Cylinder

Throttle Cables

61717 Overall length =710 mm



Foot Throttle Cable 3050 3060 3065 3070
From Serial No S (Length 710mm)

61718 Overall length =710 mm



Foot Throttle Cable 3050 3070

429982 Thread Ø= 8 mm
Overall length =1270m
Outer cable=1110mm



Throttle Cable 4245 4255 4265
4300 1245mm 4 Cylinder

429981 Thread Ø= 8 mm
Overall length =1530 mm
Outer cable=1365 mm



Throttle Cable 4260 4270 & 4360
4370 - 1530mm

429980 Thread Ø= 8 mm
Overall length =1560 mm
Outer cable=1365 mm



Throttle Cable 4260
4270 4360 4370
1560mm

61944 Thread Ø= 5 mm
Overall length =845 mm
Outer cable=710 mm



Hand Throttle Cable 6100 6200 8100 8200 From

61931 Thread Ø= 5 mm
Overall length =800 mm
Outer cable=640 mm



Hand Throttle Cable 6120 -
6190

62740 Thread Ø= 12 mm
Overall length =1280 mm
Outer cable=1120 mm



Hand Throttle Cable 5400 6200
8200

62747 Thread Ø= 12 mm
Overall length =1500 mm
Outer cable=1230 mm

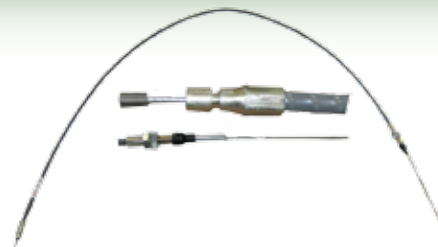

Hand Throttle Cable 5425 5435 5445 5455
5460 5465 6445 6455 6460 6470 6465
6475 6480 6485 6490 6495 6497 6499
7465 7475 7480 7485 7490

Pull To Stop Cables

6492

Thread Ø= 10mm
Overall length =970 mm



Stopper Cable 690 698T
965mm

6694

Thread Ø= 10 mm
Overall length =1120 mm



Stopper Cable 2000 1.15mtr - Screw In
End

6073

Thread Ø= 12mm
Overall length =1200 mm



Stopper Cable 390
1.2mtr

4344

Thread Ø= 12 mm
Overall length =1770 mm



Stopper Cable Ford 3 Cylinder 1.4mtr

1031R

Thread Ø= 9 mm
Overall length =1550 mm



Stopper Cable 1.5mtr -
Red Knob

1031

Thread Ø= 9 mm
Overall length =1560 mm



Stopper Cable Thread 10mm
Overall Length 1560m

4112

Thread Ø= 10mm
Overall length =1500 mm



Stopper Cable Ford 5000
7000 - 1.5mtr
Nut & Washer=41544

4806

Thread Ø= 9 mm
Overall length =1500 mm



Stopper Cable Red T Handle
1.5mtr

51212

Thread Ø= 10mm
Overall length =1200 mm

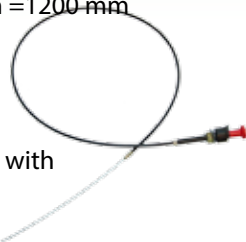

Stopper Cable with
Clamp 1.5mtr

4807

Thread Ø= 10 mm
Overall length =2200 mm



Stopper Cable Red T Handle
7Ft / 2mtr

2219

Thread Ø= 12 mm
Overall length =2100 mm



Stopper Cable
2100mm
Dexta/Super
Dexta

51577

Thread Ø= 10 mm
Overall length =3000 mm



Stopper Cable 3 mtr

1829571













































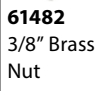









Stop Knob Black

1829570



Stop Knob Red

Exhaust Elbows & Manifolds



	Exhaust Manifold		Manifold Gasket	Exhaust Elbow		Elbow Gasket
TE20 TEA20	 63379 Oe Ref: 825458M1					
20d/35 4cyl	 62044	 62202 Exhaust Manifold Stud FE 35 3/8	 3217	 824245		 3064
35/35x3 cylinder	 37781251	 0826232 5/16 MANIFOLD to head STUD  61481 5/16 BRASS NUT	 0490481	 898011	 082075 Stud 1 21/32 x 3/8 UNF 62574 Bolt & Nut Assembly 3/8"  61482 3/8" Brass	 827877
TVO	 62044		 3217	 640010		 3064
65 MK1 192 eng	 61452		 0490481	 897913		 827877
65-203 enGine	 6663		 36862144	 897914		 827877
135 Old Type	 37781341	 0826232 5/16 Manifold To Head Stud  61481 5/16 Brass Nut	 36862143	 898011	 082075 Stud 1 21/32 x 3/8 UNF  61482 3/8" Brass Nut 62574 Bolt & Nut Assembly 3/8"	 827877
135 New Type	 37781571	 0826232 5/16 Manifold To Head Stud  61481 5/16 Brass Nut	 36862143	 1874025	 082075 3/8 Elbow To Manifold Stud  61482 3/8" Brass Nut	 827877
165 Old Type 203	 6663		 36862144	 897914		 194742
165/168/188/ 265/275/290/N/T	 37781781  62541	 082075 3/8 Elbow To Manifold Stud  61482 3/8" Brass Nut	 36862134	 1862807		 194742

Exhaust Elbows & Manifolds



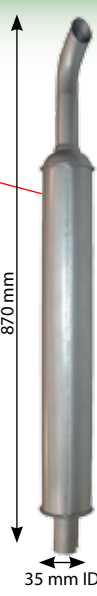

	Exhaust Manifold		Manifold Gasket	Exhaust Elbow		Elbow Gasket
165/168/188/ 265/275/290/m/t	<p>37781781 62541</p>	<p>082075 3/8 elbow to Manifold Stud 61482 3/8" BRASS NUT</p>	<p>36862134</p>	<p>1862807</p>		<p>194742</p>

	Exhaust Manifold	Manifold Gasket	Exhaust Elbow	Elbow Gasket
565/ 575 /590	<p>6615</p>	<p>36862134</p>	<p>1874771</p>	<p>1876671</p>
390/690	<p>61182</p>	<p>36862134</p>	<p>6143</p>	<p>194742</p>
698T				<p>61436 Exhaust Elbow Sleeve 698 698T</p>
698	<p>62328</p>			
3 cyl. perkins		<p>36862143</p>		
1000's		<p>3688C018</p>	<p>3347A013</p>	
100's		<p>62352</p>		

Exhausts

<p>62118</p>  <p>40 mm</p> <p>990 mm</p> <p>50 mm ID</p> <p>Exhaust 20D 35 Aluminium Metal Spray</p> <p>Clamp 62113</p>	<p>61328</p>  <p>Clamp 61298</p> <p>870 mm</p> <p>35 mm ID</p> <p>Exhaust 20D 20TVO Horizontal</p> <p>Clamp 180070</p>	<p>3237</p>  <p>40 mm</p> <p>1110 mm</p> <p>50 mm ID</p> <p>Exhaust 135 35 Black Enamel</p> <p>Clamp 1327</p>	 <p>1057</p> <p>40 mm</p> <p>1110 mm</p> <p>50 mm ID</p> <p>Exhaust 135 35 TE 20 Silver</p> <p>Clamp 1327</p>
---	--	---	--

<p>61299</p> <p>Exhaust 35 135 Extension Horizontal</p> <p>Gasket = 827877</p> 	<p>61479</p> <p>Exhaust 20 TVO Extension Horizontal (2 Hole)</p> <p>Gasket = 3064</p> 
---	--

<p>62156</p>  <p>35 mm</p> <p>1010 mm</p> <p>50mm ID</p> <p>Clamp 62113</p> <p>Exhaust 135 148 White Aluminium No Cab Short</p>	<p>3240A</p>  <p>40 mm</p> <p>1010 mm</p> <p>55mm ID</p> <p>Clamp 1326</p> <p>Exhaust 165 188 Black Enamel Also 50B</p>	<p>62067</p>  <p>35 mm</p> <p>1010 mm</p> <p>55mm ID</p> <p>Clamp 62121</p> <p>Exhaust 165 188 Aluminium Metal Spray</p>	<p>62769</p>  <p>1330 mm</p> <p>50mm ID</p> <p>Clamp 1327</p> <p>Exhaust Enamel 240 250 340 350 355 360</p>
---	---	---	---

Exhausts

3242

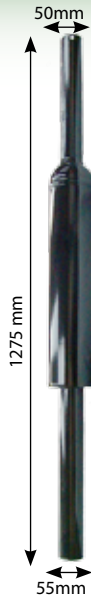

Exhaust
290 Long
Stem Black
Enamelled

Clamp
1326

1612260

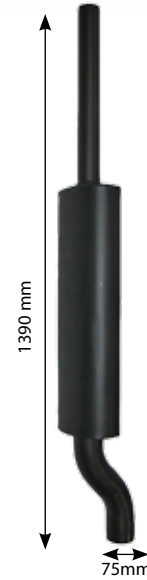

Exhaust
595 698
Black

Clamp
51201

3238



Exhaust 565 575
590 Black Enamel
265 290

Clamp
1326

3241E



Exhaust 600
Vitreous
Enamel

Clamp
1633

6324



Exhaust 699
Vitreous
Enamel

Clamp
1326

Exhausts

<p>6088</p>  <p>1090mm</p> <p>54mm</p> <p>Exhaust 375 390 Upper Enamel - High Cab</p> <p>Clamp 1326</p>	<p>6026</p>  <p>960mm</p> <p>54mm</p> <p>Exhaust 375 390 Upper Enamel 960mm</p> <p>Clamp 1326</p>	<p>6027</p>  <p>1010mm</p> <p>64mm</p> <p>Exhaust 390T 398 4200</p> <p>Clamp 1637</p>	<p>62471</p>  <p>1030mm</p> <p>70mm</p> <p>Exhaust Pipe 3120 4260 4270</p> <p>Clamp 51203</p>
<p>6016</p>  <p>420mm</p> <p>Exhaust Box 365 375 390</p> <p>Gasket = 194742 Pipe = 6026 or 6088</p>	<p>1600C</p>  <p>415mm</p> <p>Exhaust Box 390T 398</p> <p>Gasket = 6823 Pipe = 6027</p>	<p>6017</p>  <p>435mm</p> <p>Exhaust Box 399</p> <p>Gasket = 6249 Pipe = 6027</p>	
<p>6721</p>  <p>410mm</p> <p>Exhaust Box 3080 3085 3090 3095 3115 Oval</p> <p>Gasket = 6249 Pipe = 6027</p>	<p>61251</p>  <p>320mm</p> <p>Exhaust Box 3050 3060 6120 Round</p> <p>Gasket = 6249 Pipe = 6027</p>	<p>61277</p>  <p>245mm</p> <p>Exhaust Box 3065</p> <p>Pipe = 6027</p>	<p>6646</p>  <p>Exhaust Box 3070</p>

Exhausts

 <p>61934 1225 mm 130 mm</p>	 <p>6501 1190 mm 75 mm</p>	 <p>3041515 1200 mm 90 mm</p>	 <p>3322356 900 mm 100 mm</p>	 <p>62369 1690 mm 70 mm</p>	 <p>63266 1710 mm 1345 mm 180 mm</p>
<p>Exhaust 6190 6190 8120 8110 8130</p>	<p>Exhaust 298 699 Oval Clamp = 51201</p>	<p>Exhaust 2620 2625 2640 2645 Clamp = 51202</p>	<p>Exhaust 2680 2720</p>	<p>Exhaust Pipe 5425 5435 5445 5455 Clamp = 51203</p>	<p>Exhaust Stack Pipe 6465 6475 6480 **Early Type**Will Not Suit Tier 3**</p>

 <p>63241 Exhaust Box 6180 6190 8110 8120 OE Ref: 3714154M6</p>	 <p>6730 Exhaust Box 4200 4 Cylinder Turbo Gasket = 6249 Pipe = 6027</p>	 <p>62491 Exhaust Pipe Lower 5425 5435 5445 5455 4265 4365 4360 4370 6445 6455 Corner Post Type</p>
---	--	---

 <p>61481 5/16 Brass Nut</p>	 <p>086232 5/16 Manifold To Hend Stud</p>	 <p>63395 Stud Exhaust 4225 4235 4240 4260 4270 4265 4365 4325 4335 4360 4370 5425 5435 5445 5455 OE Ref: 4222341M1</p>	<h3>Exhaust Clamps</h3>  <table border="1"> <thead> <tr> <th>Part no</th> <th>Dimensions</th> <th>Diameter</th> </tr> </thead> <tbody> <tr> <td>3066</td> <td>38 mm</td> <td>8mm</td> </tr> <tr> <td>3283</td> <td>41 mm</td> <td>10mm</td> </tr> <tr> <td>3067</td> <td>45 mm</td> <td>10mm</td> </tr> <tr> <td>4137</td> <td>51 mm</td> <td>10mm</td> </tr> <tr> <td>1327</td> <td>54 mm</td> <td>10mm</td> </tr> <tr> <td>1326</td> <td>57 mm</td> <td>10mm</td> </tr> <tr> <td>1633</td> <td>64 mm</td> <td>10mm</td> </tr> <tr> <td>1637</td> <td>66 mm</td> <td>8mm</td> </tr> <tr> <td>51203</td> <td>70 mm</td> <td>10mm</td> </tr> <tr> <td>51201</td> <td>80 mm</td> <td>10mm</td> </tr> <tr> <td>51202</td> <td>92 mm</td> <td>10mm</td> </tr> </tbody> </table>	Part no	Dimensions	Diameter	3066	38 mm	8mm	3283	41 mm	10mm	3067	45 mm	10mm	4137	51 mm	10mm	1327	54 mm	10mm	1326	57 mm	10mm	1633	64 mm	10mm	1637	66 mm	8mm	51203	70 mm	10mm	51201	80 mm	10mm	51202	92 mm	10mm
Part no	Dimensions	Diameter																																					
3066	38 mm	8mm																																					
3283	41 mm	10mm																																					
3067	45 mm	10mm																																					
4137	51 mm	10mm																																					
1327	54 mm	10mm																																					
1326	57 mm	10mm																																					
1633	64 mm	10mm																																					
1637	66 mm	8mm																																					
51203	70 mm	10mm																																					
51201	80 mm	10mm																																					
51202	92 mm	10mm																																					
 <p>61482 3/8 Brass Nut</p>	 <p>082075 3/8 Elbow To Manifold Stud</p>	 <p>53431 Exhaust Manifold Stud Perkins 1000 AK</p>																																					
 <p>62298 Exhaust Manifold Stud Nut FE 35 3/8</p>	 <p>62202 Stud Exhaust Manifold 3/8 Fe 35</p>																																						

Exhausts - Clamps - Caps

Weathercaps



- 51807** 2" 51mm
- 51204** 2 1/4" 56mm
- 51199** 2 3/4" 70mm
- 51198** 2 5/8" 66mm

- 51196** 3 1/2" 89mm
- 51195** 3 1/4" 82mm



- 62801** 1 3/4" 45mm
- 59290** 3 3/4" 100mm



- 3415** 70mm 2 3/4"
- 3264** 82mm 3 1/4"



- 61579** 240 43mm
- 3169** 285 Rain Cap

Raincaps



- 62121**
- Exhaust Clamp
- 165 Lower - OE
- Type 59mm



- 61298**
- Exhaust Clamp 35 135
- Lower Horizontal



- 62105**
- Exhaust Clamp
- for Rear View
- Mirror 35 Exhaust



- 907155**
- Washer 100 200
- Exhaust Clamp Square



- 180070**
- Exhaust Clamp 20 TVO
- Heavy Duty

Stainless Steel Rain Caps



- 53350**
- 1 3/4"
- 44.45mm
- OD



- 53351**
- 2 1/4"
- 57.15mm
- OD



- 53352**
- 2 1/2"
- 63.5mm
- OD



- 53353**
- 2 3/4"
- 69.85mm
- OD



- 53354**
- 3"
- 76.2mm
- OD



- 53355**
- 3 1/2"
- 88.9mm
- OD



- 53356**
- 4"
- 101.6mm
- OD

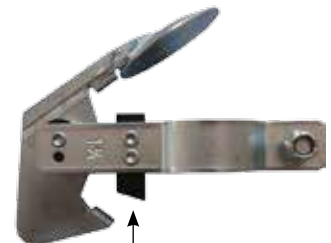

Nylon Buffer

Water Pumps

20D

62695



Water Pump Gasket 20D 35 4 Cylinder

1331



Water Pump 20D 35 4 Cylinder

825377



Water Pump Pulley Hub 20D

51404



Water Pump Key 20D 35 35X

825378



Water Pump Pulley 20D

41312784



Water Pump 35 c/w Pulley
Gasket = 0490484

3623H004



Water Pump Back Plate (Stainless Steel)

41312487



Water Pump 135 c/w Pulley
Gasket = 0490484

41312574P



Water Pump 203 192 c/w Pulley

37556123



Water Pump Plate Back 203

41312574



Water Pump Gasket=62979 203 192

61220

Water Pump 290 590 690 50HX c/w Pulley

Gasket = 36866721



U5MW0129R

Water Pump Claas Combine A6.354.4 Massey Ferguson 24 27 29 530 535 750 800 805 includes Gasket



Water Pumps

31146952



Water Pump
Pulley 212 248

41313201



Water Pump
165 - 290 212
236 248

Gasket = 36866721

41313201P

Water Pump 165 c/w
Pulley

Gasket = 36866721



41313227

Water Pump
698T 300 -
78mm Impeller

Gasket = 36866721
Repair Kit = U7LW0059

U7LW0059

Water Pump Repair Kit
698T 300

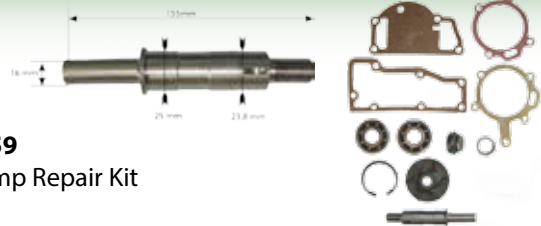

U5MW0014

Water Pump 595 698
1080 - 4.318

U7LW0055

Water Pump Repair Kit 4.318/4.318.2



41313045

Water Pump 6.354
T6.354 Massey
Ferguson Combine 500
510 515 520 525

U7LW0009

Water Pump Repair Kit T6.354



41313027

Water Pump 699 2640 2680
2720 - 399 6.354.4

Gasket = 62738

U7LW0016

Water Pump Kit T6354.4
Long Shaft

U7LW0015

Water Pump Repair Kit 2620 -
2720 6.354.4



Water Pumps

U5MW0206

Water Pump Phaser
1104C



62932
Water Pump Gasket
5400 6400

U5MW0196

Water Pump
1106C 5465
6465 6475
6480 7465



U5MW0192

Water Pump 1000's Green
Engine



62330
Gasket Phaser 4 & 6 Cylinder - Suits
U5MW019 Suits 62856

U5MW0144

Water Pump
1004.4 4
Cylinder - Non
+ Turbo 4245
4255 6130
6140 6150 Gear
Driven Only



U5MW0092

Water Pump 4360 4370 Non &
Turbo 1006.6 6 Cyl 4260 4270 from
Serial No K37008 4360 4370 3085
3095 3115 3120 3635 3655 399
6170



63421

Water Pump 5410 5420 McCormick Perkins Tier 3 Engine Suits: MF
5410 5420 (Tier 3) McCormick C-Max 100 105 80 90, CL65 75 80 ,CX100
105 110 90, MC105 110, McCormick Crawler & Orchard.
[OE Ref: 4226912M91](#)



63024

Water Pump
Conversion Perkins
P3



63022

Water Pump Perkins P6



Water Pump Components

<p>31146952</p>  <p>212/248 Water Pump Pulley</p>	<p>6043</p>  <p>Water Pump Pulley 300 3 Groove To Suit 24.6mm Shaft</p>	<p>6042</p>  <p>Water Pump Pulley 300 Single (to suit 24.6mm shaft)</p>	<p>62547</p>  <p>Water Pump Pulley 65</p>
---	---	--	---

<p>0500006</p>  <p>Water Pump Key 248</p>	<p>62553</p>  <p>Water Pump Plug 65 135 285</p>	<p>62552</p>  <p>Water Pump Plug 148 240</p>
---	--	--

<p>37711711</p>  <p>Water Pump Body 165 185 Gasket = 36866721</p>	<p>200781</p>  <p>Thermostat Housing 20 TVO</p>	<p>63264</p>  <p>Thermostat Housing TE20 TE20A TE20D Top</p>	<p>37736242</p>  <p>Water Elbow Connection 135 35</p>
--	--	--	--

<p>37733181</p>  <p>By Bass Hose Outlet for Water Pump 203 Gasket = 0490702</p>	<p>61841</p>  <p>Therm Housing TE20 / TEF20</p>
---	---

Unique Seal for Perkins Pumps. It is a problem solver seal where the shaft is damaged because there is rubber on both sides.

2418M004



Water Pump Seal 165 188 Old Type

63199



Seal 135 145 148 35 35X Water Pump 595 65 765 FE35 TEF20 165 240 285 298

Thermostats

<p>61501</p>  <p>Thermostat Massey Ferguson 781</p>	<p>2485666</p>  <p>82' Thermostat All Models Gasket=36866721</p>	<p>62110</p>  <p>Thermostat 203 Engine 7R1</p>	<p>61838</p>  <p>Radiator Cap Massey Ferguson 10 lb Long Reach</p>
---	--	---	--

Water Hoses

Model	Hose Kit	Top Hose	Bottom Hose	By Pass	By Pass
20D		 1568M (Hose Clip: 2426SS)	 2413M (Hose Clip: 2413SS)	 60682 (Hose Clip: 2393)	
35 4 CYL.		 827496 (Hose Clip: 2426SS)	 826988 (Hose Clip: 2413SS)	 826199 (Hose Clip: 2396)	
35/35X	4335 	 890195 (Hose Clip: 2426SS)	 186968 (Hose Clip: 2426SS)	 0202016 (Straight) (Hose Clip: 2397)	 34821422 (Bend) (Hose Clip: 2413SS)
65		 827930 (Hose Clip: 2426SS)	 828147 (Hose Clip: 2426SS)	 020080 (Straight) (Hose Clip: 2426SS)	 0201562 (Bend) (Hose Clip: 2426SS)
135 148	4336 	 897455 (Hose Clip: 2426SS)	 186968 (Hose Clip: 2426SS)	 0202016 (Straight) (Hose Clip: 2397)	 34821422 (Bend) (Hose Clip: 2413SS)
165 203		 898064 (Hose Clip: 2413SS)	 828147 (Hose Clip: 2413SS)	 020080 (Hose Clip: 2413SS)	 0201562 (Hose Clip: 2413SS)
240 250 550		 1869514 (Hose Clip: 2413SS)	 1662089 (Hose Clip: 2426SS)	 0202016 (Hose Clip: 2397)	 34821422 (Hose Clip: 2413SS)

Water Hoses

Model	Hose Kit	Top Hose	Bottom Hose	By Pass	By Pass
165/ 175/ 185/ 265/ 565	 4341	 899144 (Hose Clip: 2413SS)	 885563 (Hose Clip: 2413SS)		
168/ 185/ 188/ 575/ 590	 4337		 885563 (Hose Clip: 2413SS)		
675 690		 6179 (Hose Clip: 2413SS)	 885563 (Hose Clip: 2413SS)		
595 1080		 516546 (Hose Clip: 2426SS)	 520309 (Hose Clip: 2426SS)		
698 298		 6523	 6524 (Hose Clip: 2426SS)		
699		 6322 (Hose Clip: 2443)	 6323		



Water Hoses

Model	Hose Kit	Top Hose	Bottom Hose	By Pass	By Pass
698T		 6179 Hose Clip: 2426SS)	 885563 (Hose Clip: 2426SS)	 6062 (Hose Clip: 2396)	
375/ 390 390T /398	 4667			 6062 (Hose Clip: 2396)	
399 - 6354		 6965	 6676 (Hose Clip: 2426SS)		
399 PHASER		 6776 ( 62149		
2000/ 3610 3630/ 3650		 6599	 6598 (Hose Clip: 2443)		
3050/ 3060 3065/ 3080 3090		 62257	 62258		
6130/ 6140 6110/ 6120 6130/ 6140		 62262	 62261		
6190 8110 8120 8210 8220			 62253		 62254

Water Hoses

<p>6009 Hose Heater 300 Top - Up to Series</p>  <p>6617 Heater Hose Connection 300's</p>  <p>6008 Hose Heater 300 Bottom</p> 	<p>6469 Hose Heater 300 Top - From Series</p>  <p>6617 3Heater Hose Connection 300'S</p>  <p>6484 Hose Heater 300 Bottom</p> 	<p>6488 Hose Heater 300</p> 
<p>62266 Radiator Hose Top 4200 4300 6200 4225 - 4325 4245 - 6245 4255 - 6255</p> 	<p>62150 Radiator Hose 4200 6200 5365 Bottom</p> 	<p>62267 Hose Bypass 4225 - 4325 4335 - 6235 4245 4255</p> 
<p>62263 Hose Bypass 4245 4255 6130 6140 6150 4225 423</p> 	<p>62265 Hose Bottom 4245 4255 4225 4235 4240</p> 	<p>62264 Hose Top 4225-4325 4245- 6245 4255-6255</p> 
<p>4667 300'S Radiator Hose Kit</p> 	<p>62146 Hose Radiator 4260 4270 Top</p> 	<p>63181 Hose Radiator To Expansion Tank 6270 6280 6290</p> 

General Water Hoses & Clips

		
<p>90° Bend Hoses</p> <p>2596 1' (8' X 16')</p> <p>2597 1 1/4' 90° (8' X 16')</p> <p>2598 1 1/2' 90° (8' X 16')</p> <p>2599 1 3/4' 90° (8' X 16')</p> <p>2600 2' 90° (8' X 16')</p> <p>2601 2 1/4' 90° (8' X 16')</p> <p>2602 2 1/2' 90° (8' X 16')</p>	<p>Straight Hoses</p> <p>4530 1" X 3Ft</p> <p>4531 1 1/8" X 3Ft</p> <p>4532 1 1/4" X 3Ft</p> <p>4533 1 3/8" X 3Ft</p> <p>4534 1 1/2" X 3Ft</p> <p>4535 1 3/4" X 3Ft</p> <p>4536 2" X 3Ft</p>	<p>2603 Hose 1 1/4" x 17" Flexible - With Wire</p> <p>2609 Hose 1 1/2" x 19" Flexible With Wire</p> <p>2615 Hose 2" x 23" Flexible With Wire</p>

Hoses Clips

Original Type

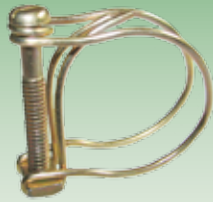

Part No	Diameter (""")	Diameter (mm)
50999	5/16" - 15/32"	8-12
50998	3/8" - 5/8"	10-16
50997	15/32" - 3/4"	12-20
50996	5/8" - 1"	16-25
50995	23/32" - 1"	18-26mm
50992	7/8" - 1 3/16"	23-36
50991	1 27/64" - 1 39/64"	36-41mm
50990	1 21/32" - 1 27/32"	42-47mm
50989	1 49/64" - 1 31/32"	45-50mm
50988	1 5/16" - 2 3/8"	40-60mm
50986	2 3/8" - 3 3/16"	60-80
50985	2 3/4" - 3 1/2"	70-90

Standard Type



Part No	Diameter (mm)	TYPE
2340SS	9.5-12	Stainless Steel
2345SS	11-15	Stainless Steel
2346SS	12-20	Stainless Steel
2357	16-25	
2357SS	16-22	Stainless Steel
2364SS	18 - 25	Stainless Steel
2394	23-35	
2394SS	25- 35	Stainless Steel
2396	28-48	
2397SS	30 40	Stainless Steel
2413SS	35-50	Stainless Steel
2426SS	45-60	Stainless Steel
2440	50-70	
2440SS	55-70	Stainless Steel
2441SS	60-80	Stainless Steel
2443	70-90	
2443SS	70-90	Stainless Steel

Small Hose Clips

Part No	Diameter (mm)
59659	11
59660	13
59658	14
59661	17



Heavy Duty Clamp

Part No	Diameter (mm)
51934	122 - 130
51933	113 - 121



Radiators

61961



Radiator 20D
Cap = 41228

61700



Radiator TVO 20

61649



Radiator 35 4 Cylinder

4820



Radiator 35

4821



Radiator 135

4823



Radiator 240 250

62122



Radiator 550
Tractor

62499



Radiator 65

4824



Radiator 265 275 290 30
D 50 E 50 EX 675 690 4
Row 82mm wide* Filler
neck is below the bonnet

63184



Radiator Frame 265 285
290 ID 80mm

61818



Radiator 575

4822



Radiator 165 188 - 4 Row
73mm

63189



Radiator 340 342 350
352 355 360 362

6200



Radiator 375 390 399 Early
Type Short Engine 6354 **
6892 is Late Type **

6892



Radiator 399 Phaser
1006.6 Eng

63130



Radiator 4245
4255 4265

Radiators

62735



Radiator 698
698T 699

62294



Radiator 3050 - 3065 &
6120 - 6140

63259



Radiator 3050 3060
3065 Early

62205



Radiator 3070 3075 3085
3095 LATE 3115 3120 6150
6160 6170 6180

62268



Radiator 3125
From Serial No. B249038->

62295



Radiator 6190 8110-8130
3635-55 3635 > B249038
3645 > B249040 3655 >
B284013

62333



Radiator Massey Ferguson
6265 - 6290

63176



Rubber Pad Radiator Pack of
2 133 135 140 145 148 152
230 231 235 240 245 250 255
260 263 550 560 592

Radiator Cowls

62372



Radiator Cowl 20D
** Radiator 61961 **

62001



Radiator Cowl 35 35X
Steel

897766



Radiator Cowl 135

1829475



Radiator Cowl 165 188

62625



Radiator Cowl 230 240 253 263 550

62664



Radiator Cowl 285

62975

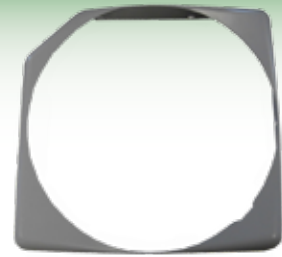

Radiator Cowl FE35

Radiator Taps

62707

Radiator
Tap 398 399
3000 4200



1851095

Radiator Tap
- Massey
Ferguson
Ford



63020

Tap Block 20D
Brass



63405

Drain Tap 1/4
BSP TE20 TEA20
TED20 TEF20



1874445

Radiator Cap 200 500



2083

Radiator Cap Massey
Ferguson & Ford 10 Lb



Fanblades

<p>3278 Fanblade 35 35X - 4 Blade</p> 	<p>3277 Fanblade 135 148 - 15.5" 4 Blade</p> 	<p>1761 Fanblade 165 590 16" 6 Blade Hole Diam- eter 40mm</p> 	<p>62530 Fanblade 20 TVO</p> 
<p>61577 Fanblade 398T 6 Blade 6110 - 6140</p> 	<p>1930 Fanblade 17" - 6 blade (With Pilot Hole)</p> 	<p>1932 Fanblade 18" - 6 Blade (With Pilot Hole)</p> 	
<p>63314 Fanblade Massey Ferguson 5465 6465 6475 6480 7465 7475 7480 OE Ref: 4282823M1</p> 	<p>63313 Fanblade Massey Ferguson 6465 6475 6480 6485 6490 6495 7465 7475 7480 7485 7490 7495 ** 63312 is Viscous Fan ** OE Ref: 3786157M1</p> 	<p>63318 Fanblade Massey Ferguson 5460 5465 5470 6280 6290 6460 6470 8210 8220 ** 63315 is Viscous Fan ** OE Ref: 3781005M91</p> 	
<p>63312 Viscous Fan Massey Ferguson 6480 6485 6490 6495 7480 7485 7490 7495 ** 63313 is Fanblade ** OE Ref: 3789256M1</p> 	<p>63315 Viscous Fan Massey Ferguson 6280 6290 6460 6470 8210</p> 		
<p>63319 Viscous Fan Massey Ferguson 3075 3085 3095 3115 3120 3125 3635 3645 3655 5425 5435 5445 5455 6150 6160 6170 6180 6235 6245 6255 6260</p> 	<p>63311 Viscous Fan Massey Ferguson 6497 6499 OE Ref: 4281538M1</p> 		
<p>63317 Viscous Fan Massey Ferguson 8150 8160</p> 	<p>63316 Viscous Fan Massey Ferguson 5425 5435 5445 5455 6235 6245 6255</p> 		
<p>1884738 Fanblade 135 240 550 350 Outer 395mm 40mm</p> 	<p>1884777 Fanblade 135 240 550 350 Inner 395mm 40mm</p> 		
<p>1885172 Fanblade 165 Outer 410mm 41mm</p> 	<p>1885173 Fanblade 165 Inner 410mm 41mm</p> 		

Fan Belts



Part No	Models	OE Ref	Size
62141	Fan Belt 20D 35 Narrow		20 x 985
V771	Fan Belt 20D/35 4 Cylinder	826960M1	20 x 985
2235	Fan Belt 35 3 Cylinder	828729M1	13 x 1175
2240	Fan Belt 135 / 7600 Double Pulley	890982M1	13x 1225
2255	Fan Belt 165/188	1447317M1	13x1275
4379	Fan Belt 365 375 390	1693745M1	13 x 1490
6964	Fan Belt 399 Phaser Pair	3614706M92	13 x 1520
6765	Fan Belt 399 A6.354.4 Pair	3595070M91	13 x 1440
3790	Fan Belt 200 500	81822583	13 x 1400
2260	Fan Belt 240	3637306M9	13 x 1300
4380	Fan Belt 698		13 x 1500
1244	Fan Belt 698T Pair	1687610	10 x 1500
4381	Fan Belt 699 Pair	1688216M91	13 x 1445
2300	Fan Belt 2640 2680 Pair	3045111M91	13 x 1500
6766	Fan Belt 2640 3080 3090 Pair	3381364M91	13 x 1515
6898	Fan Belt 3125 3635 3645 6190 8110 Pair	3582953 M91	13 x 1575
429968	Fan Belt 42's With Air Conditioning Pair	3817582M1	13 x 1400
429969	Fan Belt 42's High Visibility Tractor	3815256M1	13 x 1295
429970	Fan Belt 42's High Visibility With Air Conditioning	3815257M1	13 x 1295
62545	Fan Belt 5445 5455 5460 c/w Air Conditioning	3389525M1	13 x 1100
62534	Fan Belt 5445 5455 5460 c/w Hi Vis	3780604M91	13 x 1295
429973	Fan Belt 4215 4220 Pair	3637598M91	13 x 1275
61379	Fan Belt 6235/6255 & 6465/6480 Pair (1455mm Long 7465/7480)	3780608M91	13 x 1455
61380	Fan Belt 6245/6255 & 6260/6290 Pair 4260/4270 - 1405mm Long	3780606M91	13 x 1405
62538	Fan Belt 6260 6270 6280	3780138M91	13 x 1390
62539	Fan Belt 6260 6270 6280 c/w Air Conditioning	3386214M1	13 xx 1150
62536	Fan Belt 6460 6470	4274692M91	13 x 1420
62532	Fan Belt 6460 6470 c/w Air Conditioning	4275784M1	20 x 1060
62533	Fan Belt 6475 6480	3779379M91	13 x 1425
63230	Fan Belt 4225 4235 4240 4245	3810420M1	10 x 1275

Air Conditioning

62843

Compressor Air Conditioning
4200 5300 5400 Also fits 6200
8100 8200
OE Ref: 3782613M2



62845

Filter Drier Air
Conditioning
4200 4300
OE Ref:
3712495M1



62844

Valve
Expansion Air
Conditioning
4200 4300
OE Ref:
3904313M1



63294

Compressor Air
Conditioning 5400
6400 7400 8400
OE Ref: 3789035M1



63295

Compressor Air
Conditioning 300 4200
4300 5400 6100 6200
Series Landini 1000 1000s
12500 1300 14500 16500
OE Ref: 1077956M91

62581

Belt Air Conditioning
Compressor
OE Ref: 3809174M1



62841

Belt Air Con Compressor Hi Vis
Tractor
OE Ref: 3614715M2



63296

Control Switch Temperature 3050 3060 3065 3070
3080 5445 5455 5465 6180 6255 6270 6290

53109

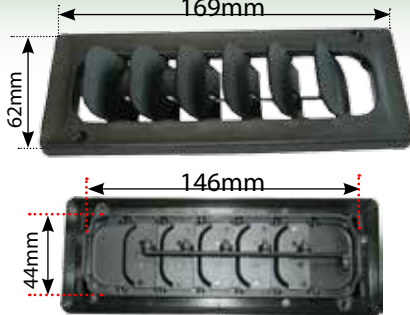

Air Vent 169 x 62 x 12mm

42190

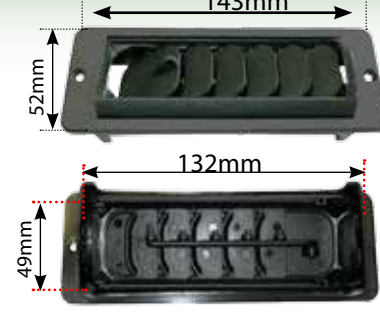

Air Vent CNH JCB 143
x 52 x 27mm Cut Out
132 x 49mm

62846

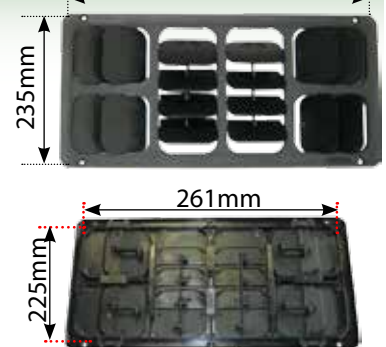

Air Vent 280 x 235mm
Cut Out 261 x 225mm
CX & Massey Ferguson

62847

Air Vent 390 162 x 35 x 20mm
Cut Out 150 x 32mm

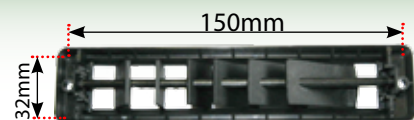
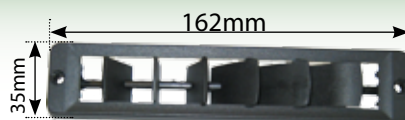

53110

Air Vent Round 100mm No
Spigots Outer Diameter
100mm Cut Out 76.5mm

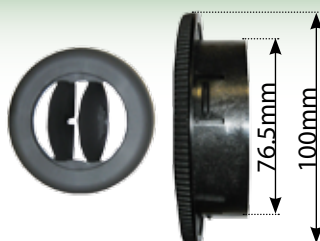

53111

Air Vent Round 100mm c/o 65mm Spigot
Outer Diameter 100mm Cut Out 76.5mm

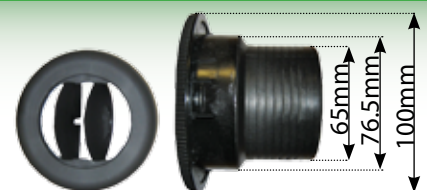

Temperature Gauges and Senders

62059



Gauge 135 178 188 Temperature
Smith Type

51213



Gauge Temperature c/o 2.5
mtr Flex

1877719



Gauge 200 500 Water
Temperature

2514



Volt Meter for Alternator
230 240 250

6747



300's Fuel & Temperature
Gauge

3417



Gauge Water Temperature
Electric Calibra

1877731



Temperature Sender 200 300
500 600 2640 31

3456



Temperature Sender
5/8" 18 UNI - 42mm

3437



Temperature Sender CASE
IH 4210/20/30/40 485,
XL/584/685/695,XL/784/785,X-
L/885,XL/895, Thread 1/2" x 14
NPFT

Silicone & Gasket Sealer



1861108
Silicone Sealer - 80ml



1861117
Gasket Sealer - 100g



1475
Silicone Sealer 300ml



1478
Gasket Sealer 350g

Gasket Paper

Plain

Sold Per Metre

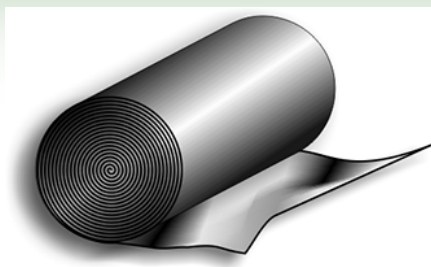

3167 - 0.80 Mm Paper
3168 - 1.00 Paper

Plain

Sold Per Metre

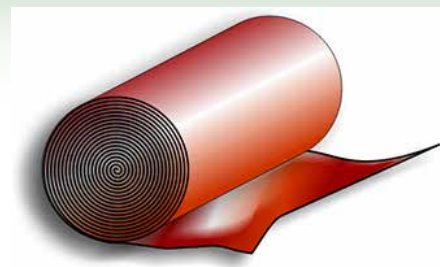

3171 - 3 Mm Cork

3 Cylinder

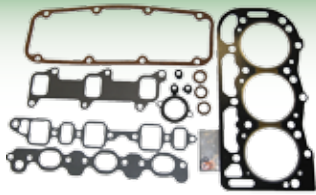

2055
Head Gasket Set Ford 3610 4110 4600
4610 c/w Genuine Head Gasket
** 2055R is Replacement Type **

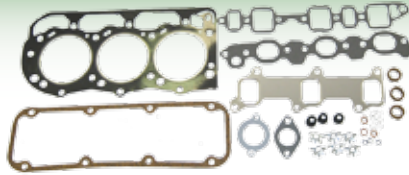

2055R
Head Gasket Set Ford 3610 4110
4600 4610



3741
Sump Gasket Set Ford 2000 3000
4000 4600

4 Cylinder

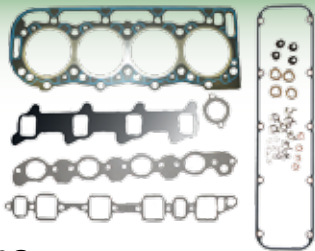

42230G
Head Gasket Set Ford 10 4 Cylinder c/o
Genuine Head & Rocker Cover Gaskets
** 3375 is Replacement Type **

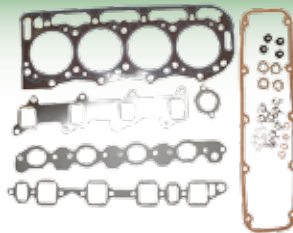

3375
Head Gasket Set Ford 5610 6610
7610 5600 7600 4 Cylinder 10s **
Kit 42230G has Genuine Head &
Rocker Gaske



3740
Sump Gasket Set Ford 5000 7600
5610 6610 6710 7710 5610 6610
6710 7710

42232G
Head Gasket
Set Ford 40
4 Cylinder
c/o Genuine
Head & Rocker
Cover Gaskets
** 42232 is
Replacement
Type **

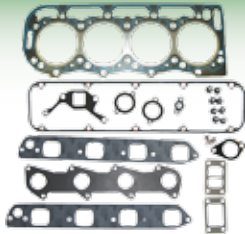

42232
Head
Gasket Set
Ford 40 4
Cylinder **
42232G has
Genuine
Head &
Rocker
Gasket **

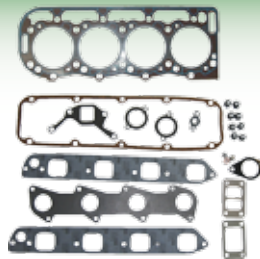

Q2830920
Gasket Cylinder Head
1.15mm 4 Cylinder NEF
[OE Ref: 2830920](#)



4188
Sump Gasket Set Ford 5640-7740



6 Cylinder

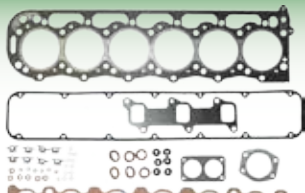

42231G
Head Gasket Set Ford 10 6 Cylinder
c/o Genuine Head & Rocker Cover
Gaskets ** 1957 is Replacement
Type **

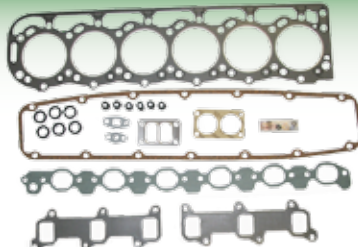

1957
Head Gasket Set Ford 7810 8210 TW
** Kit 42231G has Genuine Head &
Rocker Gaske



2909
Sump Gasket Set Ford TW 10 30

42233G
Head Gasket Set
Ford 40 6 Cylinder
c/o Genuine Head
& Rocker Cover
Gaskets ** 42233
is Replacement
Type **

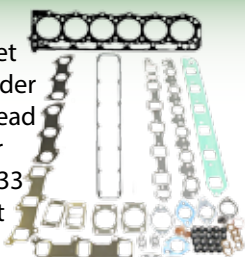

42233
Head Gasket
Set Ford 40
6 Cylinder
** 42233G
has Genuine
Head & Rocker
Gasket **

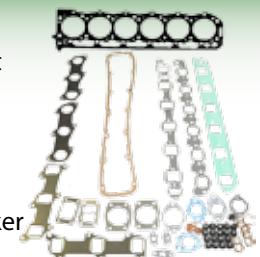

4198
Sump Gasket Set Ford 7840

Head Gaskets

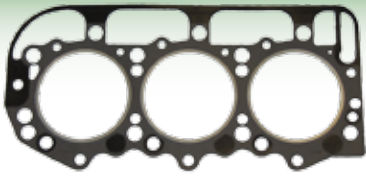

1279
Head Gasket Ford 2000 3000



1213
Head Gasket Ford 4000 4600 Genuine
** 1213R is Replacement Type **

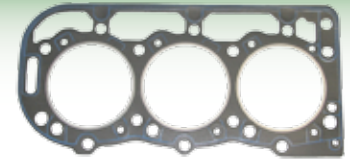

1213R
Head Gasket Ford 4000 4600
** Genuine is 1213 **



43007
Head Gasket Ford 4000
1.40mm Thick ** 1213R is
1.60mm Thick **



1214G
Head Gasket Ford 6600 7600
4 Cylinder 10s 4 Cylinder 40S
** Kits 42230G 42232G **



1214E
Head Gasket Ford 6600 7600 7610
** Kit 42232 **

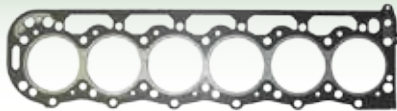

1949G
Head Gasket Ford
TW 7810 7910 8210
Genuine ** Kit
42231G ** 1949I is
Replacement Type **

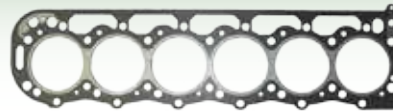

1949I
Head Gasket Ford TW
7810 7910 8210 **
1949G is Genuine **



401961G
Head Gasket Ford
7840 8240 TS115
Genuine ** Kit
42233G **



401961
Head Gasket Ford
7840 8240 TS115 **
401961G is Genuine
** ** Kit 42233 **



41878
Head Gasket Ford TM120 - TM190
G170 - G240 & 70 Series Genuine

Rocker Cover Gaskets



2065
Rocker Cover Gasket Ford 4000
After 1965



2066
Rocker Cover Gasket Ford 5610
7710



409736
Rocker Cover Gasket Ford 10 4
Cylinder Genuin 5610 6410 6610
6710 6810 7410 7610 7710 ** Kits
42230G 42232G **



41016
Rocker Cover Gasket 6
Cylinder Ford



409917
Rocker Cover Gasket Ford 6 Cylinder
Genuine 7810 7910 8210 TW 8530
8630 8730 8830 41016 is replacement



42250
Gasket Ford Intake
Manifold TM TS

N Gaskets



48811
Valve Cover Gasket Fordson
8N 9N

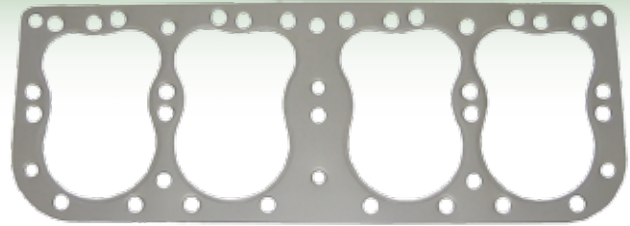

48810
Head Gasket Fordson 8N 9N
Metal



48809
Exhaust Manifold Gasket
Fordson 8N 9N KIT



48831
Governor Housing Gasket Fordson 2N
8N 9N



48800
Carburettor Repair Kit Fordson 2N
8N 9N



48833
Oil Pump Cover Inlet Gasket
Fordson N's 600/700/800/900



48840
Gasket Fordson N Carburetor to
Manifold 2N 8N 9N NAA 600 700



48827
Oil Relief Valve Gasket Fordson
2N/8N/9N

N Gaskets



48828
Front Cover Gasket Fordson 8N <263843 Serial



48829
Front Cover Gasket Fordson 8N >263843 Serial

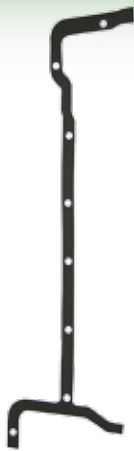

48835
Oil Pump Gasket Fordson
8N 9N RH



48812
Gasket Fordson N
Carburettor Bowl to Body
801/901



48841
Gasket Fordson N's
Carburettor Bowl to Bod
NAA/2N/600/700/8N/800/9N/900



48838
Air Cleaner Gasket Fordson
NAA 600 8N



U5LT0012
Head Gasket Set 35 35X Copper Fordson Dexta



41625
Engine Set Dexta & TE20
(P3 Engine)



41624
Sump Gasket Set P3 Dexta
** 41962 is for Dexta &
Super Dexta **



41962
Sump Gasket Set Dexta Super
Dexta ** 41624 is for P3 **

Major & Super Major Gaskets



1094
Head Gasket Fordson Major Standard**
Heavy Copper Type Gasket is 48853 **



1095
Major Rocker Cover Gasket



41459
Super Major Engine Side Cover Gasket

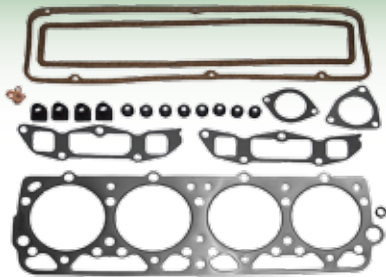

3056
Head Gasket Set Major



43147
Rope Seal For Crankshaft
Major Super Major



41475
Timing Cover
Gasket Super Major
- Front

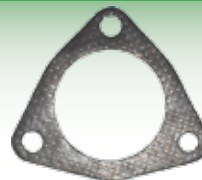

41469
Exhaust Elbow Gasket
Super Major



41219
Air Intake Manifold
Gasket Set Super
Major



41300
Timing Cover Gasket
Major

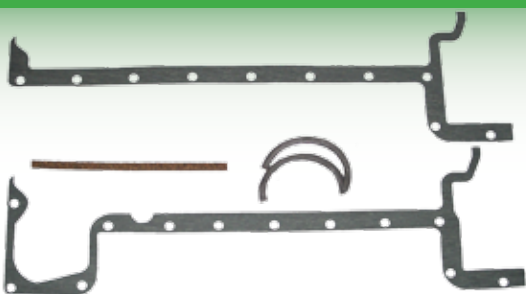

1096
Sump Gasket Set Major Super Major



43147
Rope Seal For
Crankshaft Major
Super Major



881991
Seal 65 Half Shaft
Inner Timing Cover
Seal Super Major

3 Cylinder Individual Gaskets



2069
Sump Gasket Ford 2610 4610

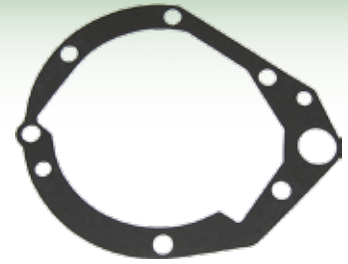

2384
Hydraulic Pump Gasket Ford
4600

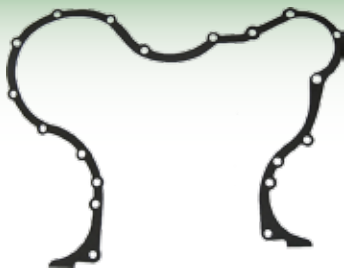

2070
Timing Cover Gasket Ford

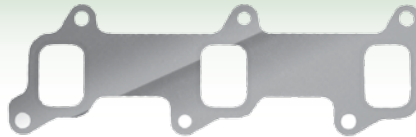

1173
Exhaust Manifold Gasket
Ford 4000 4600

1173S
Exhaust Manifold Gasket
Ford 3 Cylinder Steel



1398
Water Pump Gasket Ford
Dexta 2000 5000



1402
Water Pump Gasket
Ford Inside



1171
Gasket Crankshaft Seal Ford Rear
**Seal & Gasket kit - 2269 **



3863
Thermostat Gasket Ford -
All Models



3240
Hydraulic Pump Gasket Ford 6600
7610 Engine Mounted



4156
Exhaust Elbow Gasket
Ford



3675
Oil Pump Gasket Ford



2071
Air Intake Manifold Gasket Ford 3 Cylinder



3927
Air Intake Manifold Gasket Ford 3610

4 Cylinder Individual Gaskets



1929
Crankshaft Gasket Ford 7610 Rear



1171
Rear Crankshaft Seal Gasket

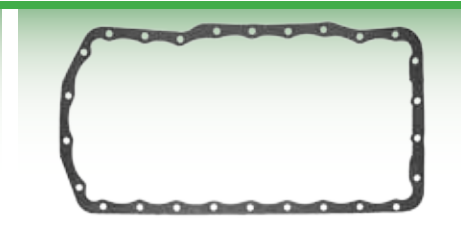

2006
Sump Gasket Ford 5000



1398
Water Pump Gasket



1402
Inside Water Pump Gasket



3863
Thermostat Gasket



3674
Inner Timing Cover Gasket



2070
Timing Cover Gasket



1172
Air Intake Manifold Gasket
Ford 5000 Square



1174
Exhaust Manifold Gasket Ford 5000

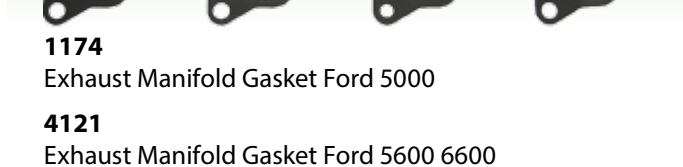

4121
Exhaust Manifold Gasket Ford 5600 6600



1379
Air Intake Manifold Gasket Ford Round

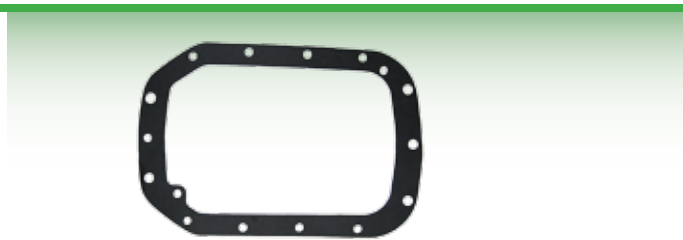

1176
Centre Housing Gasket Ford 5000 40s

Assorted Gaskets

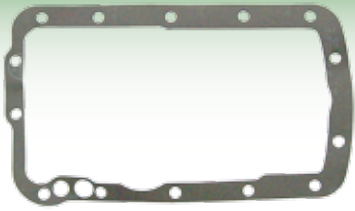

1196
Lift Cover Gasket Ford 4000

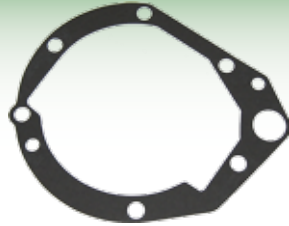

2384
4/4600 Hyd. Pump Gasket



3388
Hydraulic Pump Gasket Ford 5000

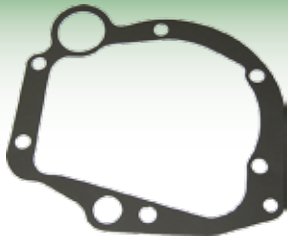

3862
Hydraulic Pump Gasket Ford 40 7610
** Kit is 404605 **

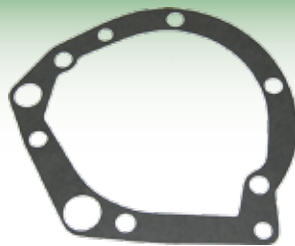

3861
Hydraulic Pump Gasket
Ford 6600 7600



3245
Gearbox Lid Gasket Ford 5000



1523
Trumpet Housing Gasket Ford

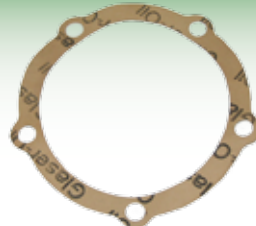

1524
Input Housing Gasket Ford



1177
Lift Cover Gasket Ford



1406
Gear Box Lid
Gasket Ford
4000 4600



41015
Sump Gasket Ford 7840 - 8340
TM120 - 190 TS115 TW10 - TW30
8530 - 8830 7810 - 8210



4757
Lift Cover Gasket
Ford TW15 20 Hyd.



41555
Exhaust Manifold Gasket
Ford 7840 8340



4758
Hydraulic Pump
Housing Gasket
Ford TW15 20



409734R
Gasket Exhaust Manifold Ford
New Type **Made of Thick Gasket
paper**

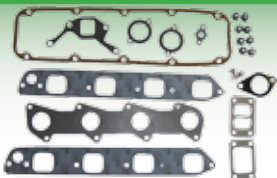

4194
Head Gasket Set Ford 5640 - 7740 No
Head Gasket

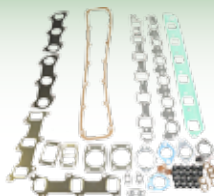

42186
Head Gasket
Set Ford 7840
6 Cylinder no
Head



409734
Ford Exhaust Manifold Gasket
(New Type) 3 & 6 Cylinder

Fuel System Parts



Nylon Fuel Pipe

- 3904** 1/4" Nylon Pipe (30 Meters)
- 3903** 5/16" Nylon Pipe (30 Meters)

Steel Fuel Pipe

- 1917** 3/16" Steel Pipe (10 Ft)
- 1910** 1/4" Steel Pipe (10 Ft)
- 1905** 5/16" Steel Pipe (10 Ft)

Rubber Fuel Pipe

- 2604** 3/16" Fuel Hose (10 Mtr)
- 4525** 3/16" Fuel Hose (Per Mtr)
- 2605** 1/4" Fuel Hose (10 Mtr)
- 4526** 1/4" Fuel Hose (Per Mtr)
- 2606** 5/16" Fuel Hose (10 Mtr)
- 2607** 3/8" Fuel Hose (10 Mtr)
- 4528** 3/8" Fuel Hose (Per Mtr)



61348
Fuel Filter Blanking
Plug KIT

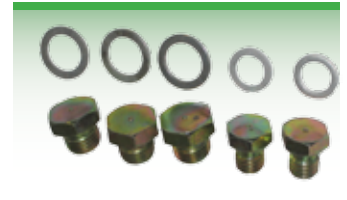

61709
Blanking Plug Kit For Fuel
Filter Head



1721 3/16" Barrel Olive
1296 1/4" Barrel Olive
1297 5/16" Barrel Olive
3430 3/8" Barrel Olive



61702
Fuel Filter Head Banjo
Bolt



61707
Fuel Filter Head
Blanking Plug All
Models



1850167
Fuel Assembly Screw
20 TEF 35



Part No.	I.D.
3970	3/16"
3971	1/4"
3972	5/16"
3973	3/8"



41568
Fuel Tap Brass 2000 3000 4000 5000 7000
Fits 2636/46/56/66/7600 3900 ** Gauze
1426 * 4100 57/6700 5900 7600 7700
Fordson Major



1978
Fuel Line Pipe Union 1/4'
Male



1924
Fuel Line Pipe Union
5/16" Male



62950
Joiner Fuel Pipe Brass
Long



1974
3/16 Union Male Oil Pressure



1975
Heater Plug Pipe 3/16 Male



1973
Oil Pressure Pipe 3/16' Union
F/M

Fuel System Parts



51489
Fuel Strainer (Input/Output 1/2"
- 20 UNF)



51483
Hand Primer for Bosch Type
Fuel Pump M16 x 1.5



3416
Fuel Separator Ford
& Massey Ferguson



61235
Fuel Filter Assembly
100 200 c/o Long
Filter Also Fits 4200
4300 6200



51482
Hand Primer for Z Type
Fuel Pump M25 x 1.5



51492
Fuel Filter Head & Base



51491
Fuel Strainer (Input/
Output M14 1.5)



51487
Fuel Filter Dual - Inlet/
Outlet M14 x 1.5



41874
Fuel Filter Assembly Ford
TM120 - TM155 **T6010 -
T6080 & T7030 - T7060**

Fuel Tank Senders



41872
Fuel Sender Ford TM120 - TM155
up to **Up to Serial No C5132**

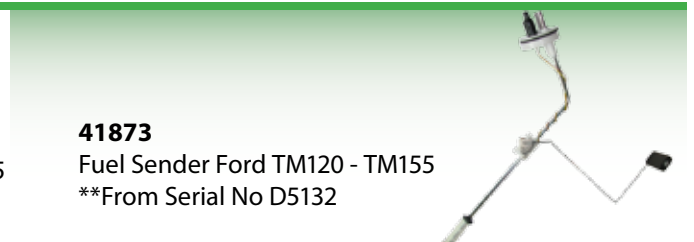

41873
Fuel Sender Ford TM120 - TM155
**From Serial No D5132

Super Q Cabs



4224
Fuel Sender Manual Dash - 1985 -1987



4191
Fuel Sender Ford 7610
Electronic Dash (1985)

Q Cab



4170
Fuel Sender Ford
7610 Auxillary

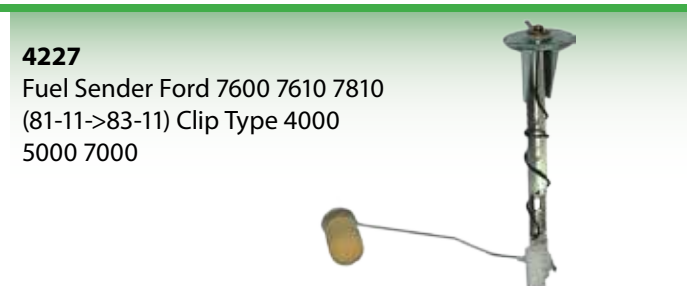

4227
Fuel Sender Ford 7600 7610 7810
(81-11->83-11) Clip Type 4000
5000 7000

AP Cab

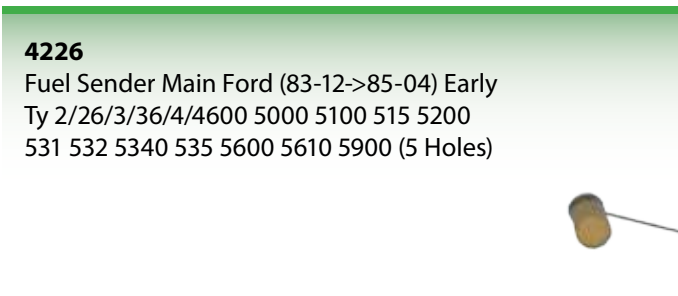

4226
Fuel Sender Main Ford (83-12->85-04) Early
Ty 2/26/3/36/4/4600 5000 5100 515 5200
531 532 5340 535 5600 5610 5900 (5 Holes)



40's Cab



409720
Fuel Sender Ford 40 Auxiliary
Fuel Tank 5640 6640 7740
7840 8240 8340



409721
Fuel Sender Ford 40 Main Fuel Tank
5640 6640 7740 7840 8240 8340
With Auxillary

New Holland



42898
Fuel Sender
New Holland
TD65 75 85 95

Injector Pipes



41159
Injector Pipe Ford No 1
(Simms Pump)

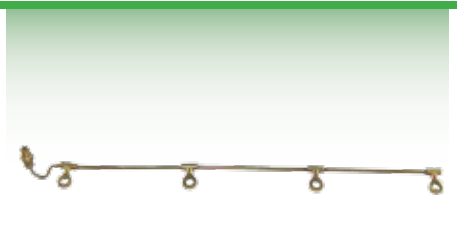

41460
Leak Off Pipe Major

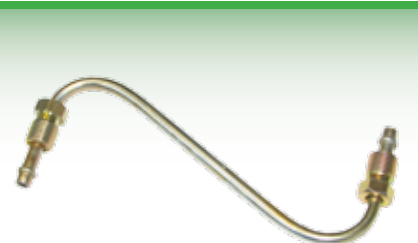

41642
Pipe Filter To Injector Pump
Fordson Major

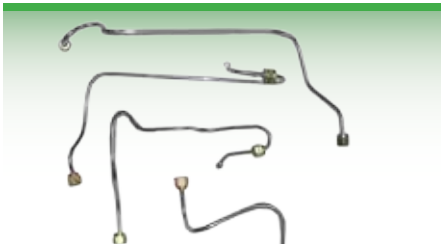

41210
Injector Pipe Set Ford 6610 - SET 4
for Sims Pump (Set of 4)

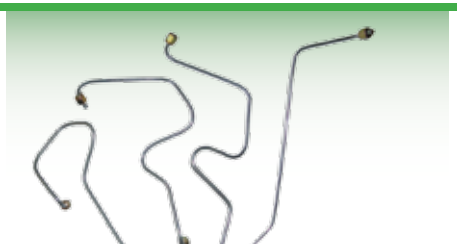

41208
Injector Pipe Set Ford 5000 - SET 4
for Bosch Pump (Set of 4)



41484
Injector Pipe Set Super Major

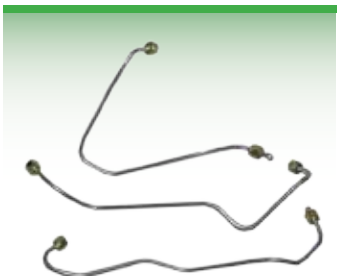

41211
Injector Pipe Set Ford
2000 3000 3600 - SET 3
And fits 3610 for Bosch
Pump (Set of 3)



41209
Injector Pipe Set Ford
5000 - SET 4 for Sims
Pump (Set of 4)



4688
Leak Off Pipe Ford 5640
6640 7740

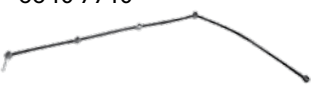

43302
Fuel Pipe Leak Off Ford
5110 5610 6610 6710
6810 7410 7610 7710 6600 7600
OE Ref: 83925431

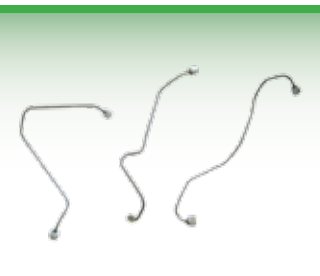

42134
Injector Pipe Set Ford 4000 -
Set 3 3 Cylinder



3084
Injector Pipe Ford
6600 6610 No 1



3083
Injector Pipe Ford
6600 6610 No 2

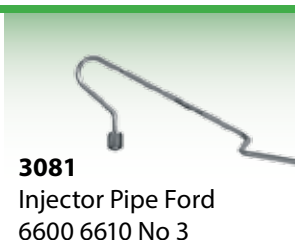

3081
Injector Pipe Ford
6600 6610 No 3

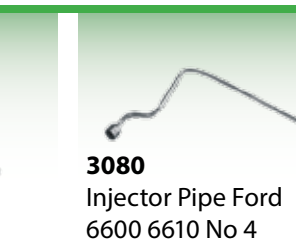

3080
Injector Pipe Ford
6600 6610 No 4



4350
Injector Pipe Ford
5000 - 7000 No 1

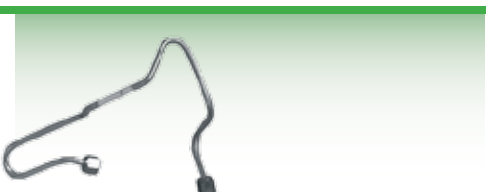

4351
Injector Pipe Ford
5000 - 7000 No 2

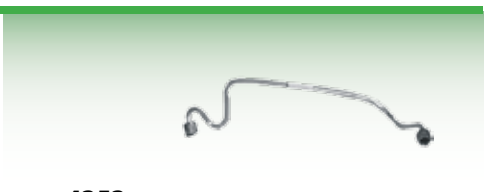

4353
Injector Pipe Ford
5000 7000 No 4

Fordson Dexta Fuel System

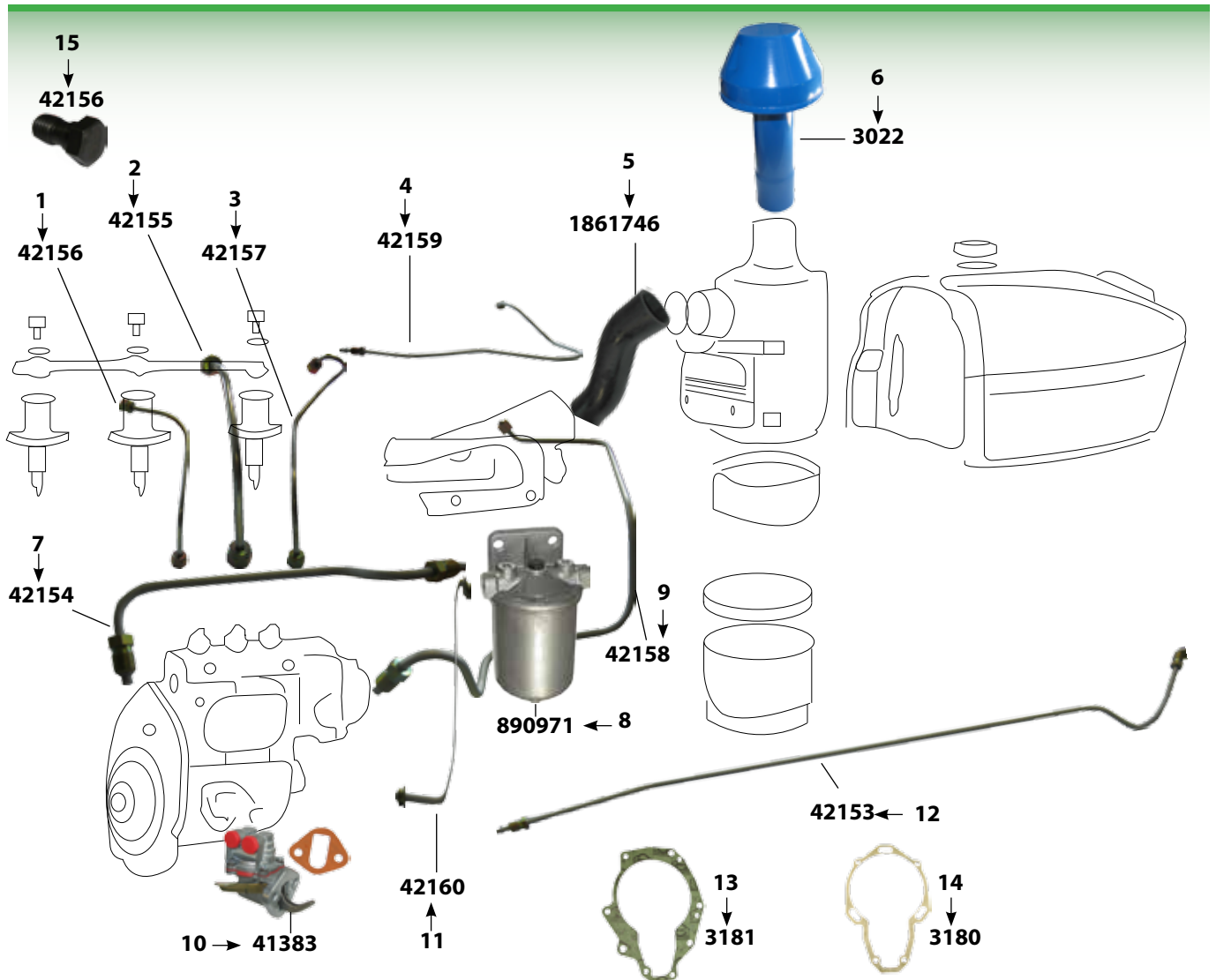

1 42156
Injector Pipe Dexta - No 2
1957 - 1962

2 42155
Injector Pipe Dexta - No. 1
1957 - 1962

3 42157
Injector Pipe Dexta Rear -
No. 3 1957 - 1962

4 42159
Fuel Pipe Dexta Leak Off
Rail to Tank 1957 - 1962

5 1861746
Air Cleaning Hose 135 Dry
1438 Dexta Super Dexta

6 3022
Air Filter Hat Ford 2000
3000 - 54 x 7" Pipe
54mm diameter Pre
Cleaner

7 42154
Fuel Pipe Dexta Filter
to Injection Pump Oute
1957 - 1962

8 890971
Fuel Filter Assembly 35X
Fordson Major Dexta

9 42158
Fuel Pipe Dexta Injection
Pump to Inlet Manif

10 41383
Fuel Lift Pump Dexta

11 42160
Fuel Pipe Dexta Filter
to Injection Pump Inne
Inner 1957 - 1962





12 42153
Pipe Dexta Tank To Pump
Year 57 - 62

13 3181
Fuel Pump Gasket Simms

14 3180
Fuel Pump Gasket Simms

15 42943
Injector Banjo Bolt Dexta



Injector Pumps

 <p>3233F380 Injector Pump Ford 3000 3600</p>	 <p>3233F661 Injector Pump Ford 2000 2310 2610 2810 2910</p>	 <p>3233F390 Injector Pump Ford 4000 4600</p>	 <p>3249F951 Injector Pump Ford 5000 6600 6700</p>
---	--	--	--

 <p>43036 Flange Injector Pump Ford</p>	 <p>42243 Injector Ford TS80 5610 5640 6640</p>	<p>43233 Diaphragm Injector Pump Major Power Major Sup Major OE Ref: 81714474</p> 
---	---	---

 <p>INJECTORS 2000, 3000, 4000, 5000,7000 SERIES</p>	<table border="1"> <tr> <td>43262</td> <td>4000 Series</td> <td>C5NE9F593C</td> </tr> <tr> <td>43263</td> <td>5600 5700 3610 3910</td> <td>D9NN9F593BA</td> </tr> <tr> <td>43264</td> <td>2000 3000 5000</td> <td>D0NN9F593A</td> </tr> <tr> <td>43265</td> <td>7600 7700</td> <td>D4NN9F593C</td> </tr> </table>	43262	4000 Series	C5NE9F593C	43263	5600 5700 3610 3910	D9NN9F593BA	43264	2000 3000 5000	D0NN9F593A	43265	7600 7700	D4NN9F593C
43262	4000 Series	C5NE9F593C											
43263	5600 5700 3610 3910	D9NN9F593BA											
43264	2000 3000 5000	D0NN9F593A											
43265	7600 7700	D4NN9F593C											

Fuel Filter Assembly & Parts

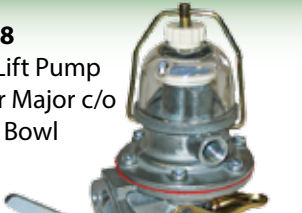
 <p>41752 Buffer Injector Pump Major / Super Major</p>	 <p>41533 Rubber Gasket for Glass Bowl</p>	 <p>41528 Glass Bowl for Lift Pump Fordson Major</p>	 <p>41458 Fuel Lift Pump Super Major c/o Glass Bowl</p>
---	--	---	---

 <p>3044 Hand Primer Pump Ford</p>	 <p>41383 Fuel Lift Pump Dexta</p>
--	--

 <p>4659 Fuel Lift Pump Major</p>	 <p>43204 Fuel Lift Pump Ford D Series Fordson Major & Combines</p>	 <p>2641478 Fuel Lift Pump 165 188 Ford 2000 -7600 2 Stud **Simm's Pump***</p>	 <p>7571 Fuel Lift Pump Fiat 55 to 80- 90 480 - 780 L60-L95 JX60- JX95 3435 - 7635 ** Not for TL100 **</p>
---	---	---	--

 <p>41875 Fuel Tank Strap Ford TM120 - TM155 716mm</p>	 <p>41920 Fuel Pipe Olive Ford 2600-7810 40's TW TS90-TS115 8360-8560</p>
--	--

Fuel Filter Assembly & Parts

 <p>409660 Fuel Tank Cap Ford 40 Auxillary (91-98)</p>	 <p>2775 Fuel Tank Cap Ford 7610</p>	 <p>59840 Fuel Tank Cap John Deere 00 10 20 Lockable JCB Fasttrac Teleporter Case MX & MXM Series</p>	 <p>59436 Fuel Tank Cap John Deere 00 10 20 No Lock JCB Fasttrac Telehandler Claas Axion Celtis Massey 43 54 64 74 84 Series Case MX & MXM</p>
 <p>4079 Fuel Tank Cap Ford - All Models</p>	 <p>41473 Fuel Tank Cap Super Major</p>	 <p>42240 Fuel Tank / Radiator Cap Dexta, Major</p>	 <p>41925 Seal Fuel Sender Ford 40 Series</p>
 <p>41924 Locking Ring Tank Ford</p>	 <p>1183 Fuel Tank Connection Ford 10 40 With Auxillary</p>	 <p>41568 Fuel Tap Brass 2/3/4/5/7000 Fits 2636/46/56/66/ 7600 3900 4100 57/6700 5900 7600 7700 Dexta Major</p>	 <p>1426 Fuel Tap Gauze Ford Push On Type ** Suits 41568 ** Screw Type is 43025 **</p>  <p>43025 Fuel Tap Gauze Screw In Type Ford ** Push in Type is 1426 **</p>
 <p>41050 Fuel Tank Ford 2000 3000 3600 3610</p>	 <p>41319 Fuel Tank Ford 4000</p>	 <p>4726 Fuel Tank Ford 5000 6600 6610 ** Wont Fit Q Cab **</p>	
 <p>43014 Fuel Pipe Tank To Tank Ford TM115 TM190</p>	 <p>41691 Foot Throttle Kit Ford 5000 Also fits Ford 6600 6610</p>	 <p>41690 Foot Throttle Kit 2000 - 3610 4000</p>	

TS/TM/M Fuel Pumps



409709
Fuel Lift Pump Electric Ford TS TM M c/w Filtr MXM **
Glass Bowl Assy is 409704 **



409790
Fuel Lift Pump Electric Ford TS/TM/M Case
MXM LB90 LB110 LB115 555E 655E 675E



409704
Fuel Filter Glass Bowl Ford All Models
8160 8560 M TM ** Complete Pump is
409709 **



409790R
Fuel Lift Pump Electric Ford
TS/TM/M Case MXM



409789
Seal Kit Ford
TS TM M For
Under Pump



409700
Fuel Filter
Pump Loom
Ford - New
Type



42067
Fuel Lift Pump Ford T4 T5 T6 TLA
TSA Case JXU



404676
Hand Primer Pump
Ford 40 **sell kit
41789**



41789
Fuel Filter Assembly Ford 40 c/o
Hand Primer KIT - Made from 1 x
404676 & 1 x 3082

41613R
Fuel Lift Pump Ford 60 M
TM110-140 Electronic



42995
Adaptor Pack
To Suit 41613R



41613
Fuel Lift Pump Ford 60
M TM110-140 Electronic

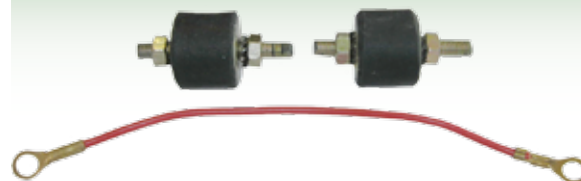

53133
Mounting Kit Fuel Lift Pump TM110 - 1140
** Suits 41613 & 41613R **

Pull To Stop Cables

Thread Ø= 9.15 mm
Overall length =1105 mm
Outer cable=895 mm

6492
Stopper Cable 690 698T 965mm



Thread Ø= 11 mm
Overall length =1600 mm
Outer cable=1315 mm

6694
Stopper Cable 2000 1.15mtr - Screw In End
2620 2625 2640 2645 2680

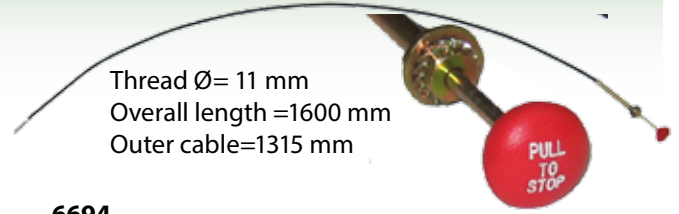

Thread Ø= 15.5 mm
Overall length =1440 mm
Outer cable=1230 mm

6073
Stopper Cable 390 1.2mtr



Thread Ø= 15 mm
Overall length =1590 mm
Outer cable=1390 mm

4112
Stopper Cable Ford 5000
7000 - 1.5mtr 4 Cylinder
Nut & Washer=41544



Thread Ø= 12 mm
Overall length =1400 mm
Outer cable=1130 mm

4344
Stopper Cable Ford 3 Cylinder
1.4mtr

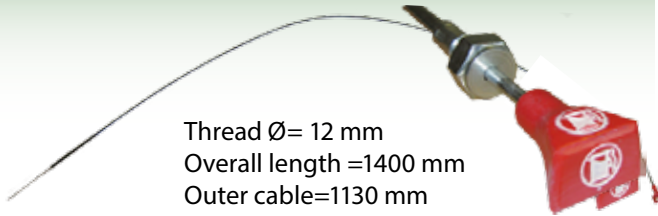

Thread Ø= 9.70 mm
Overall length =1550 mm
Outer cable=1260 mm

1031R
Stopper Cable 1.5mtr - Red Knob



Thread Ø= 15 mm
Overall length =1560 mm
Outer cable=1260 mm

1031
Stopper Cable Thread 10mm
Overall Length1560m



Thread Ø= 11 mm
Overall length =1700 mm
Outer cable=1400 mm

4806
Stopper Cable Red T Handle 1.5mtr



Pull To Stop Cables



51212
Stopper Cable with Clamp 1.5mtr

Thread Ø= 12 mm
Overall length =2270 mm
Outer cable=2240 mm

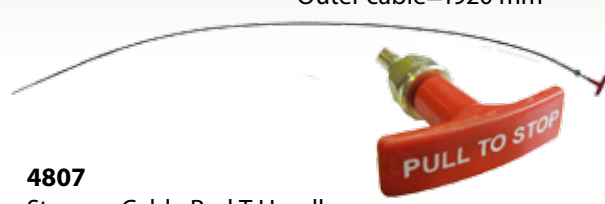

4807
Stopper Cable Red T Handle
7Ft / 2mtr

Thread Ø= 10 mm
Overall length =2220 mm
Outer cable=1920 mm



2219
Stopper Cable 2100mm
Dexta/Super Dexta



51577
Stopper Cable 3 mtr

Thread Ø= 12 mm
Overall length =3060 mm
Outer cable=2870 mm



1829571
Stop Knob Black



1829570
Stop Knob Red

Cable End Clamps



51956
Cable End
1/4" (6mm)



51957
Cable End
9/32" (7mm)



51959
Cable End
11/32" (9mm)



51958
Cable End Assortment
Pack of 25
1/4" x 3/8", 11/32" x 1/2",
9/32" x 1/2"



41544
Nut & washer Stop Cable Ford
5000 6600 6610



51957
51956
51959

Cables

Rev Counter

Overall length =1110 mm
Outer cable=1020 mm



4211
Rev Counter Cable Ford 7610 Super Q 5110 5610 6410 6610 6710 6810 7610 7710

Overall length =1250mm



3212
Rev Counter Cable Ford 3000 4000 1250mm Also fits 5000 6000 7600 4610 5610 6610 7610 Q Cab



42229
Rev Counter Cable Ford 7810 - 8210 TW 30s Super Q Cab

Overall length =110 mm



3361
Rev Counter & Speedo Extension Ford

Throttle Cable

Thread Ø= 7 mm
Overall length =600 mm
Outer cable=530 mm



4360
Throttle Cable Ford 3 4 Cyl AP Q Cab Short Short 600mm

Thread Ø= 10 mm
Overall length =850 mm
Outer cable=700 mm



409803
Foot Throttle Cable Ford 5640 - 7740ng

Thread Ø= 10 mm
Overall length =1490 mm
Outer cable=1380 mm



42039
Hand Throttle Cable Ford 60 M TM

Thread Ø= 8 mm
Overall length =1774 mm



404991
Hand Throttle Cable Ford TS90 100 110 115 1774mm

Thread Ø= 19 mm
Overall length =1050 mm



404992
Foot Throttle Cable Ford TS90 100 110 -m

Overall length =560mm



41825
Hand Throttle Lever Ford Chrome **All 1000 Series**2000 3000 4000 5000 7000



43281
Throttle Cable Ford New Holland T6000 T6030 -T6070 TS100A TS115A TSA Delta TS115A TS110A TS130A

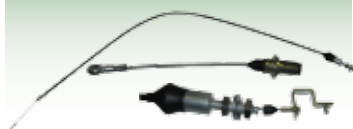

42230
Foot Throttle Cable Ford 60 M TM Series

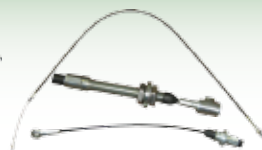

42133
Foot Throttle Cable Ford TS115 ***Overall Length 1300mm***

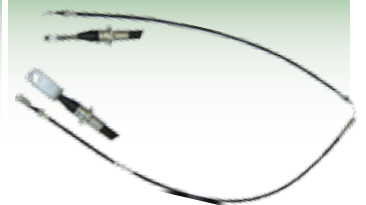

42132
Foot Throttle Cable Ford TS115 Early

Overall length =1470mm



4268
Throttle Cable Foot & Hand Ford 10 Super Q 5110 5610 6410 6610 6710 7610 7710 7810 7910 8210 8530 8630 8730 8830 TW15 TW25

Overall length =1790mm



409804
Hand Throttle Cable Ford 5640 - 7740 1790mm

404855

Ford 40's Foot Throttle Cable 990mm Long



404856

Hand Throttle Cable Ford 40 -1940mm **Suits 16 x 16 transmission**

Engine Parts

43313

Oil Sump Ford 5640 6640 7740
7630
OE Ref: 81866343



43314

Oil Sump Ford
5610 6410 6610 6710 6810 7410
7610 7710 5600 5700 5900 6600
6700 7600 7700 4000 5000 7000
7100 7200 5030 OE Ref: 83936297



3858

Balancer Unit Ford 10's
(Gear Ref D8NN6B302AB)

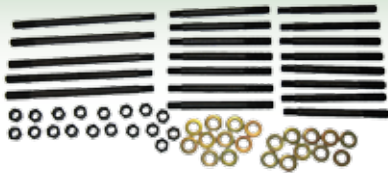

1937

Head Stud Kit
Ford 6610 7610

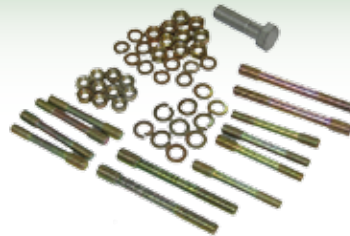

2091

Timing Cover Bolt
Kit Ford 6610 7610



2498

Engine Block Plug 4
Cylinder



3326

Timing Cover Seal
Ford 7610 7840 60.3
x 82.7 x 12



2302

Idler Gear Hub to
suit New Block
Ford



4080

Oil Filler Cap
Ford Engine/
Transmission



43311

Oil Filler Cap Ford 5640
6640 7740 7840 8240
8260 8360 8560 Case

2283

Seal & Gasket Kit Rear
Crankshaft Ford 7610
7840



2269

Seal & Gasket Kit
Rear Crankshaft
Ford

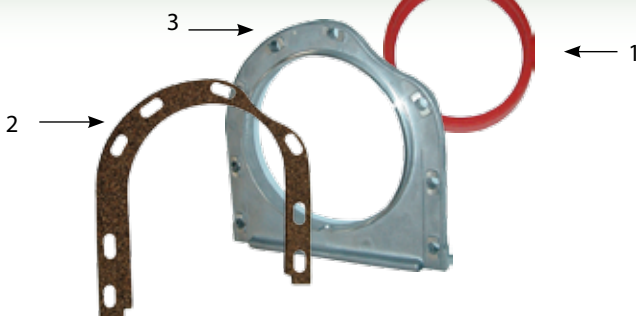

1. **2074** 56/6600 Rear C/S Oil Seal
- 1A. **2074G** Gen 56/6600 Rear C/S Oil Seal
2. **1929** 7610 Rear Crankshaft Gasket
3. **2301** 10'S Rear Oil Seal Retainer Plate

Engine Parts & Frost Plugs



41468
Inlet Valve Seal Super Major



41461
Injector Seal Super Major



41535
Seal Major for Injection Pump

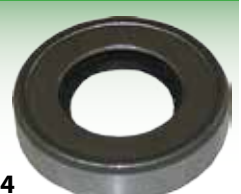

41464
Auxiliary Drive Seal Major 18 X 37

48804
Fordson N's 6 Volt Coil
2N/8N/9N/ Front
Mounted Distributor



- 4280** 21mm Frost Plug
- 4083** 22mm Frost Plug
- 3959** 29mm Frost Plug
- 4084** 38mm Frost Plug
- 4085** 40mm Frost Plug
- 4086F** 44mm Frost Plug (Long Type)
- 41692** 41.27mm Frost Plug



53654
Frost Plug Kit 7/8" 1 1/2" 1 9/16"
1 3/4"



48802
Tuning Kit Fordson N's (Front Mnted Dist)
2N/8N/9N (Front Mounted Distributor)



41524
Front Crank Seal Ford
Dexta Super Dexta



4799
Valve Cotter (Ford all
models) QTY 12



41439
Valve Tappet Major



41225
Engine Oil Filler Cap Dexta
/ Super Major Dexta/Super
Dexta/Fordson/ Fordson
SuperMajor



31134151
Bush 35 65 135
165 203 Small
End Conrod Bush
Dexta Super Dexta



41463
Cylinder Head To
Block Seal Major

Pistons & Rings

<p>41023 Liner Major Engine 100mm (1961- 1965) Double Groove</p> 	<p>41113 Liner Seal Super Major (5mm)</p> 	<p>41110 Liner Major Super Major - 100mm Bore (1957-1961) Single Groove</p> 	<p>41112 Liner Seal Major for 41110 Liner (5mm)</p> 	<p>41576 Liner Seal Major Super Major (2.9mm)</p> 
<p>61899 Liner Dexta P3-144 Perkins Engine</p> 	<p>41024 Liner Ford Semi Finished 4.4</p> 	<p>41060 Piston & Pin Power/Super Major (100mm) Major 1957- 1965</p> 		
<p>41322 Piston Ring Major Standard 100mm</p> 	<p>41322 Piston Ring Major Standard 100mm</p> 	<p>41622 Piston Rings Dexta (3.5 ")</p> 		
<p>4090 Ring Ford 4000 5000 6600 Standard Set of 3 Rings per Piston</p> 	<p>3554 Ring Kit Ford 7600 (Genuine) wont fit 6610</p> 	<p>42963 Ring Set Ford 3000 5000 (-> 3/68) 3100 3300 3600 3900 5100 (-> 3/68) 5200 5600 (->9/80) 5700 (->9/80)</p> 	<p>42951 Piston c/o Rings Ford 3000 5000 (-> 3/68) 3100 3300 3600 3900 5100 (-> 3/68) 5200 5600 (->9/80) 5700 (->9/80)</p> 	
<p>41081 Piston Kit Early 7000 (4 per Kit) ** 17mm to top of first ring** 41080 is late</p> 	<p>41250 Piston & Ring Assembly Ford 6600 (Singles)</p> 	<p>41251 Piston & Ring Assembly Ford 6610 (Singles)</p> 	<p>42954 Piston c/o Rings Ford 5000 (4/68->) 5100 (4/68 ->) 5200 (4/68 ->) 5600 (10/80 - 5900 (-> 7/87) 6600 (->9/80) 6700 (->9/80)</p> 	

Engine Kits

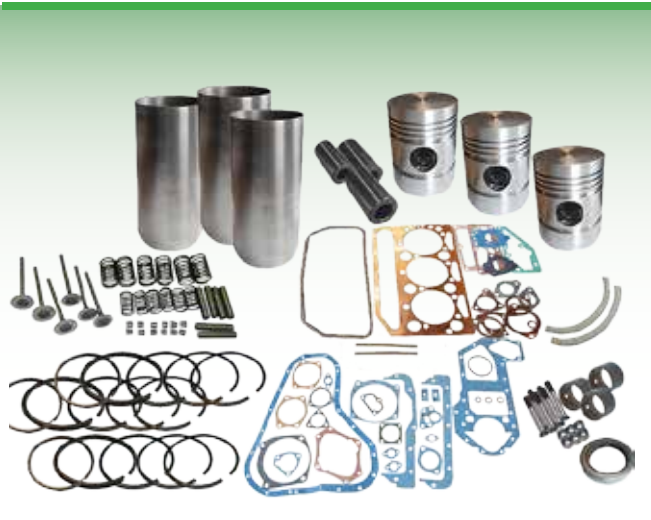

43219
Engine Kit Fordson Dextra



43220
Engine Kit Fordson Super Dextra

COMPONENTS - FORDSON DEXTA, SUPER DEXTA

43208

Piston Fordson Dextra



50044

43209

Ring Set Fordson Dextra

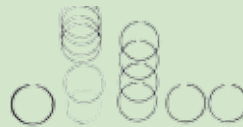

745823M91

43210

Liner Fordson Dextra



81803819

43214

Liner Fordson Super Dextra Unfinished



81803820

Engine Parts

ENGINE KITS - FORDSON MAJOR, POWER MAJOR, SUPER MAJOR



43221 Engine Kit **Fordson Major**



43222
Engine Kit **Fordson Power Major**

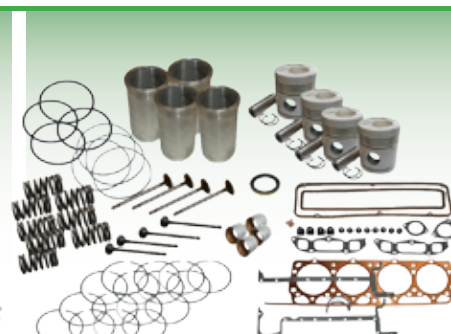

43223
Engine Kit **Fordson Super Major**

COMPONENTS - MAJOR, POWER MAJOR, SUPER MAJOR

43215 Conrod Bush Fordson Major Power Major Super



E1ADKN6207B

43216 Valve Spring Fordson Major Power Major Super



E1ADDN6513

43217 Exhaust Valve Fordson Major Power Major Super



723F6505ABA

43218 Inlet Valve Fordson Major Power Major Super



E1ADDN6507

41060 Piston & Pin Power/Super Major (100mm)



81710338

41107 Piston & Pin Fordson Major 100mm 1952-1956



E1ADDN6110J

43289 Big End Bearings Ford Major Power Major Super Major



81854542 x 4

Engine Parts

41217

Ring Gear Dexta / Super
Dexta A3.144 A3.152



41476

Ring Gear Fordson Major
Flywheel



42247

Crankshaft Major Super
Major c/o Bearings

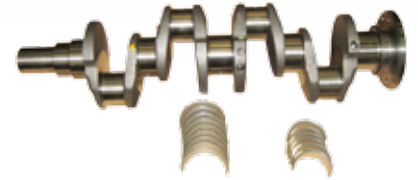

42893

Crankshaft Super Dexta 2000
3000 4.2" Stroke



42894

Crankshaft Ford 4000 4600
4610 4.4" Stroke



42895

Crankshaft 5000 5600 5610 6600
7000 7600 7700 7610 7710 78 Teeth
Gear 4.2" Stroke



42897

Crankshaft 6600 6700 7600 7700 7610 7710
5600 5610 78 Teeth Gear 4.4" Stroke



42896

Crankshaft 5610 6610
6710 7410 7610 7710 76
Teeth Gear 4.4" stroke



Big End Bearings 000/00/10 Series

Early Type (36mm)

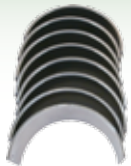

42924	Standard
42925	10 Thou
42926	20 Thou
42927	30 Thou

Late Type (32mm)



42932	Standard
42933	10 Thou
42934	20 Thou
42935	30 Thou

Main Bearing Kit 000/00/10 Series



42928	Standard
42929	10 Thou
42930	20 Thou
42931	30 Thou

Main End Bearings Major

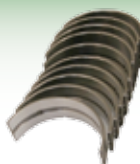





42920	Standard
42921	10 Thou
42922	20 Thou
42923	30 Thou

Engine Parts

 <p>42953 Piston c/o Rings Ford 2000 5000 7000 2100 2300 3100 3300 3600 4100 4200 4400 4600 5100 5200 5600 5700 6600 6700 7100 7200</p>	 <p>42956 Piston c/o Rings Ford 3100 3300 3600 3900 5100 (3/68 >) 5200 (3/68>) 5600 (9/80>) 3000 5000 (3/68>) 3310 3150 5700 (9/80>) 3190 5190 (3/68>)</p>	 <p>42962 Piston c/o Rings Ford 5610 6610 6810 7010 (850179M>) 7610 5640 6640 7740 8160 8260 8360 Turbo 8560 Turbo TS100 TS110 TS80 T</p>
---	---	--

 <p>42957 Piston c/o Rings Ford 6610 (7/87>) 6710 7810 7910 (4/86>) 8210 (4/86>) TW5 (4/86>) 4600 (Non Headland) 6600 (10/80>) 6700</p>	 <p>42958 Piston c/o Rings Ford 6410 6610 (8/87>) 6710 (8/87>)</p>	 <p>42959 Piston c/o Rings Ford 6810 7410 7610 (8/87>) 7710 (8/87>)</p>
---	--	---

 <p>42960 Piston c/o Rings Ford 7010 7610S 7740 8340 Turbo</p>	 <p>42952 Ring Set Ford 2000 5000 7000 2100 2300 3100 3300 3600 4100 4200 4400 4600 5100 5200 5600 5700 6600 6700 7100 7200</p>	 <p>42955 Ring Set Ford 3100 3300 3600 3900 5100 (3/68>) 5200 (3/68>) 5600 (9/80>) 3000 5000 (3/68>) 3310 3150 5700 (9/80>)</p>
--	---	--



42961
Ring Set Ford 5610S 6610S 6810S 7010 (850179M>)
7610S 5640 6640 7740 8160 8260 8360Turbo
8560Turbo TS100 TS110 TS80 TS9



42966
Ring Set Ford 6810 7410 7610 (8/87>) 7710 (8/87 >)



Q4897480
Oil Pump NEF Case New
Holland T6000 C190 L190
LM Maxxum 100 110 **4
Cyl Only**



Q4897481
Oil Pump NEF Case New
Holland T6000 CR5080
CR5090 Maxxum 115
125 140 **6 Cyl Only**



Q2830559
Gasket Oil Cooler NEF Ford
TN85A T7030 T6030 T6050
TS115A TS130A TN95A
TL100A, T6040, T6020,
TS110A TL80A T6010 T705



Q2852743
Gasket Exhaust Manifold
NEF Ford TN85A T6030
T6050 TS115A TS130A
TN95A TL100A T6020
TS110A TL80A T6010 T6070

Engine Parts



Q87317238
Piston Assy Non Turbo
Standard NEF Iveco
Engine Case New
Holland TL80A TL70A
C190 LT190 LS180



Q87316211
Ring Set Non Turbo
Standard NEF Iveco
Engine Case New
Holland TL70A TL80A
C190 L180 LT190B
L5180B



Q87317243
Piston Assy Non Turbo
0.40mm NEF Iveco
Engine Case New Holland
C190 L190 ** Rings are
Q87316213 **



Q87316213
Ring Set Non Turbo
0.40mm NEF Iveco
Engine Case New Holland
C190 L190 ** Piston is
Q87317243 **



Q8094740
Piston Assy Turbo
Standard NEF Iveco
Engine Case New Holland
TSA T4000 T5000 T6000



Q8094845
Ring Set Turbo Standard
NEF Iveco Engine Case
New Holland T4000
T5000 T6000 T9000 **
Piston is Q8094740 **



Q87317252
Piston Assy Turbo
0.40mm NEF Iveco
Engine Case New Holland
T6000 C185 LT185 L185
** Rings are Q87316944
**



Q87316944
Ring Set Turbo 0.40mm
NEF Iveco Engine Case
New Holland T6000 C185
LT185 L185 LS185B **
Piston is Q87317252 **



Q2995787
Main Bearing Standard
NEF Iveco Case New
Holland T6000 T7000
C190 L190



Q2995788
Main Bearing 0.254 NEF
Iveco Engine Case New
Holland T6000 T7000

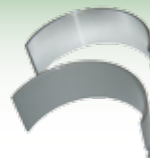

Q8093882
Rod Bearing Standard NEF
Iveco Engine Case New
Holland T4000 T5000 T6000
T7000 TLA TSA LM

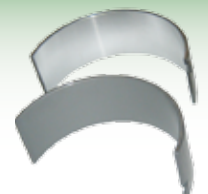

Q8094960
Rod Bearing 0.254mm
NEF Iveco Engine Case
New Holland T4000 T5000
T6000 T7000 TLA TSA LM



Q2995784
Thrust Bearing Standard
NEF Iveco Engine Case
New Holland T6000
T7000



Q2995785
Thrust Bearing 0.254mm
NEF Iveco Engine Case
New Holland T6000
T7000 TM7000



Q4890832
Seal Front NEF Iveco
Engine Case New Holland
T4000 T5000 T6000
T7000 LM TLA TSA TD TN



Q4890833
Seal Rear NEF Iveco
Engine Case New Holland
T4000 T5000 T6000 T7000
LM TSA TD TN

Engine Parts



2094
Gasket Ford
7610 Turbo



2106
Gasket Ford 7610
Turbo



2105
Gasket Ford
7610 Turbo



1981
Exhaust
Clamp
Ford 7610
Elbow to
Turbo



2565
Clamp Ford 7840
8360 Turbo TW15
TW20 TW25
TW30 TW35 8730
8830



41883
Gasket Turbo Ford TM120
- TM190



7805
Dipstick Fiat L95



4119
Dipstick Ford 2600 - 7600 Engine



3331
Dipstick Short 2000 3000 4000 5000
Engine



4173
Dipstick Ford 5000 7000
Short (Engine)

Engine Parts

51970

Conrod Bush Tapered Ford
7610 7810 TW 5110 5610 6410
6610 6710 7410 7610 7710
7810 7910 8210 8530 8630
8730 8830 5640 6640



3127

Conrod Bush
Ford Non Turbo



409872

Conrod Ford
6610



42085

Conrod Ford M TM
40 60



4809

Short Block Front Pulley
Spacer Ford 7610



2938

Flywheel Ford 7600 7610
13"



3325

Ring Gear Ford 2000 - 7600 - 128
Teeth 7610 - 8210 40 Series TS TM



4159

Flywheel Bolt Ford
(all models)

4810

Short Block Front Pulley
Key Ford 7610



3061

Valve Steam Seal
Ford 4 Cylinder



4139

Sump Plug 'O'
Ring / Washer
Ford 3/4" ID

4174

Sump Plug Ford &
135 (3/4'-16 Thr) Fits
Ford 7610 8210 TM
TS TW & CASE MXM

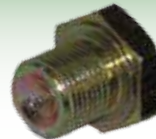

4808

Short Block Front
Pulley Seal Ford 7610



41134

Camshaft Push
Rod Ford 10 L
TW



42212

Valve Tappet Ford
TM TS



43156

Valve Exhaust Ford 7740
8340 8360 8560 8670 8770
8870 TS100 TS110 7630 Case
MXM120 MXM130 MXM135
MXM140 MXM150 Fiat G170
G190 G210
OE Ref: 81865088



43157

Valve Inlet Ford 7740
8770 8870 8970
TS100 TS110
OE Ref: 81865095

Oil Pumps & Parts

 <p>3327 Oil Pump Ford 2000 3000 4000 5000</p>	 <p>3328 Oil Pump Ford 7000 7600</p>	 <p>42883 Oil Pump Ford 30 35 L TD TN TL Series Fiat 40 50 80 90 94 L Series</p>		
 <p>3483 Oil Pump Super Major</p>	 <p>42244 Tab Washer Rear And Intermediate Cap Crankshaft Major Super Major</p>			
 <p>3329 Oil Pump Shaft & Gear Assembly 7810 Major Ford 7810/8/8600</p>	 <p>3738 Oil Pump Ford 8210 TW 10 20 25</p>	 <p>3739 Oil Pump Ford 7810 8000 8600</p>	 <p>42964 Oil Pump Ford 800 8600 9000 9200 9260</p>	
 <p>42941 Engine Oil Pump Ford 8010 7840 8240 8340 8160 8260 8360 8560 8670 8770 8870 8970 TM115 125 135 150 165 TS115 7630 Fiat G170 G190 G210</p>	 <p>42965 Oil Pump Ford 9600 9700 8630 8730 8830 TW15 TW20 TW25 TW30 TW35 7810</p>	 <p>409626 Switch Engine Oil Pressure Ford TM 135 - 180</p>	 <p>4024 Oil Pressure Switch Ford - All Models 2-8830 TW TM TS's ** 409655 is genuine **</p>	 <p>42033 Thrust Washer Set Major Power & Super Standar</p>
 <p>41224 Oil Pump Shaft Fordson / Super Major</p>	 <p>3330 Oil Pump Shaft Ford - All Models Pencil Drive</p>	 <p>409655 Oil Pressure Switch Ford Also fits TS90-115 & TS100A-135A</p>	 <p>3675 Ford Oil Pump Gasket</p>	

Exhausts

43205
Exhaust Ebro
Super 55



1415
Exhaust Dexta & Super
Dexta Silver

Clamp =3283



41729
Exhaust Ford Pre Force - 2 Piece

Cap =51807
Clamp =3067

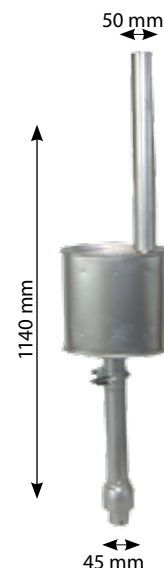

41056
Exhaust Ford Major Silver
**Universal White/Oliver
Fiat 450 - 640** Also
Super Major Power Major



3244
Exhaust Ford 2000 3000
4000 5000 Black Enamel

Cap =51807
Clamp =4137

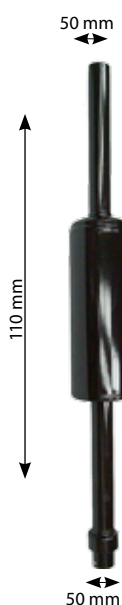

3248
Exhaust Ford 2000 3000
4000 5000 Silver Heat
Resistant

Clamp =3067

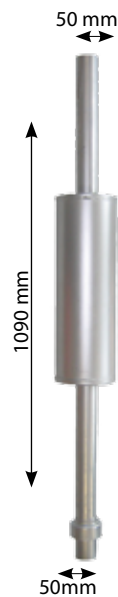

3245B
Exhaust Ford 4600 - Black
Paint Bottom Pipe 46mm
diameter 2600 2610 3600
3610 4600 4610

Clamp =1633

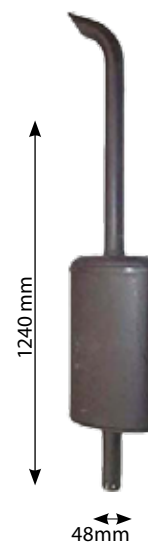

Exhausts

3246C

Exhaust Ford 6600 Swan Neck
Heat Resistant Black Paint

Clamp = 4137



3247B

Exhaust Ford 7000 7600 5610 6610
7610 7710 7810 County ** with Bent
Pipe ** Also 8210 from 82 to 85 OE Ref:
87704570



3247E

Exhaust Ford 7000 7600 5610 6610
7610 7710 7810 County ** with Bent
Pipe ** Also 8210 from 82 to 85

Clamp = 1633

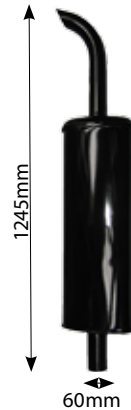

2954

Exhaust Ford TW15 8630 **2956
is for bigger TW & 30 Series**
Start year 01/01/1983



2956

Exhaust Ford TW25 TW35 & 8730
8830 **2954 is for TW15 & 8630**

Clamp =
51202

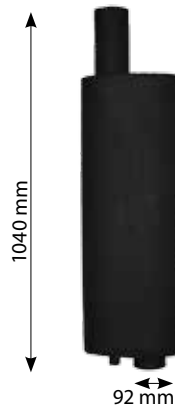

409866

Exhaust Ford 7740 7840 8240
8340 Pipe Top Enamel Also Fits
TS90 - 120 (70mm id)

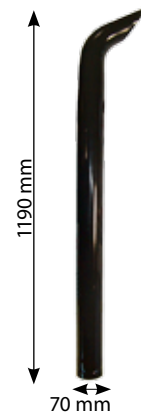

Clamp = 51203

43463

Exhaust Ford 7000 Turbo
OE Ref: D9NN5230FA



41114

Exhaust Ford 8360 8560 TM125
TM135 TM150 Fiat M135 M160
New Holland TM165 **41833 is for
Newer TM models - it has brack



Clamp = 51202

42109

Stack Pipe Ford TSA 115
T6020 4 Cylinder with
Venturi Cab



Exhausts

41558

Exhaust Box Ford 8360 - 8560 TM125 TM160 ** 42185 is TM140 Exhaust Box **



41022

Exhaust Box Ford 8160 8260 M100 M115 TM115 TM 125

Gasket = 2094



41868

Exhaust Manifold Stud Ford TM115 TM190



41556

Exhaust Screw Ford 7840



Suitable For Use On 403998, 407118, 41724, 4414

43006

Exhaust New Holland TD60 65B 70 80 90 95 Tier III TD5040 5050 TD55D 60D 65D 70D 75D 80D 85D 90D 95D TK65F 65V 75V 75M 75V 76 76M 85 85M



403998

Exhaust Box Ford 7840 Turbo 8340 Turbo

Pipe = 409866

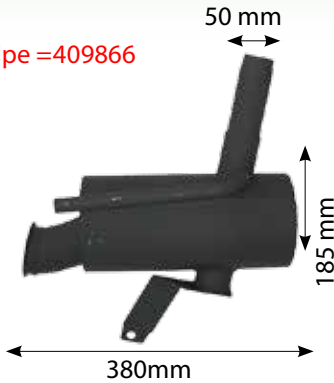

407118

Exhaust Box Ford 5640 6640 TS80 TS90 TS115 Non Turbo

Gasket = 2094
Pipe = 409866



41724

Exhaust Box Ford 5640 - 6640 Year 91-98 **Non Turbo**

Gasket = 2094
Pipe = 409866



402334

Exhaust Box Ford 7740 TS90 - 110 From 1997

Pipe = 409866

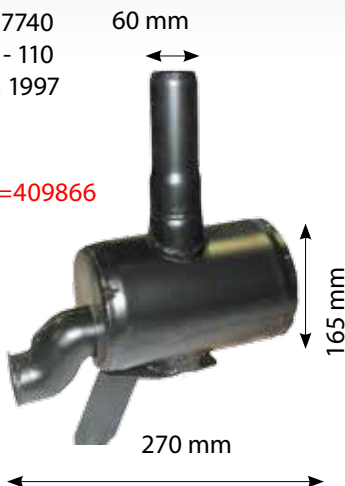

402333

Exhaust Box Ford 7740 TS90 100 110 To Year 1996

Pipe = 409866



403990

Exhaust Box Ford 7840 Non Turbo ** 403998 is Turbo Exhaust **

Gasket = 2094
Pipe = 409866

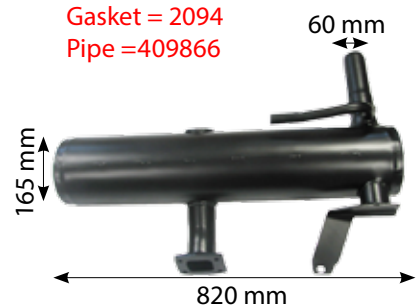

42004
Exhaust Box Ford
TS115 Non Turbo For
Corner Post Only

Pipe =41809



42185
Exhaust Box
Ford TM140



41833
Exhaust Ford
TM120 130 140 155
**This has no heat
shield**



41809
Exhaust Ford New
Holland TS115
Stack pipe only

409735
Exhaust Manifold
Stud Ford



42083
Exhaust Box Ford TSA MXU Clip Type
T6030 T6050 T6070 TS115A TS125A
TS130A TS135A



42003
Exhaust Box Ford
TS115 Turbo ***
For Corner Post
Only ***



42086
Exhaust Ford TSA
MXU Flat Flange
T6010 T6020 T6040
T6060 TS100A
TS110A



Exhaust Elbows



4414
Exhaust Elbow
Ford 4600 6600

Gasket=4156



4201
Exhaust Elbow Ford
6610

Gasket=2094

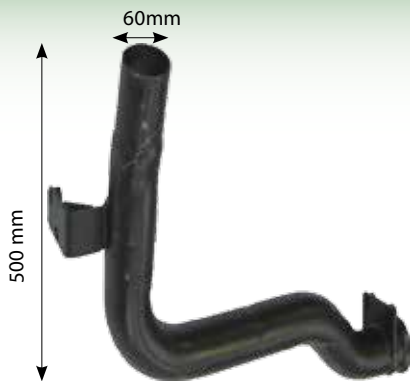

4164
Exhaust Elbow Ford
7710



4413
Exhaust Elbow Ford 7610 -
Tapered Face



2354
Exhaust Elbow Ford TW 15 20 25
30 8630 8730 8830 01/03/1990 to
01/12/1993

Exhaust Clamps & Caps

Weathercaps

- 51807** 2" 51mm
- 51204** 2 1/4" 56mm
- 51198** 2 5/8" 66mm
- 51199** 2 3/4" 70mm
- 3 1/4" 82mm
- 3 1/2" 89mm
- 4" 101mm

- 62801** 1 3/4" 45mm
- 59290** 3 3/4" 100mm

- 3415** 70mm 2 3/4"
- 3264** 82mm 3 1/4"

Raincaps

- 61579** 240 Rain Cap 43mm
- 3169** 285 Rain Cap 60mm

Stainless Steel Rain Caps

- 53350** 1 3/4" 44.45mm OD
 - 53351** 2 1/4" 57.15mm OD
 - 53352** 2 1/2" 63.5mm OD
 - 53353** 2 3/4" 69.85mm OD
 - 53354** 3" 76.2mm OD
 - 53355** 3 1/2" 88.9mm OD
 - 53356** 4" 101.6mm OD
- Nylon Buffer**

- 62121** Exhaust Clamp 165 Lower - OE Type 59mm
- 62113** Exhaust Clamp 135 135 20D 148 Lower White Aluminium
- 61298** Exhaust Clamp 35 135 Lower Horizontal
- 62105** Exhaust Clamp for Rear View Mirror 35 Exhaust
- 907155** Washer 100 200 Exhaust Clamp Square
- 180070** Exhaust Clamp 20 TVO Heavy Duty

Exhaust Clamps

- 61481** 5/16 Brass Nut
- 0826232** Exhaust Manifold Stud 135 1 1/2" x 5/16" Also Elbow Stud
- 61482** 3/8" Brass Nut
- 082075** Exhaust Manifold Stud 1 21/32 x 3/8 UNF Also Elbow Stud ** 62574 is Stud & Nut **
- 62298** Nut Exhaust Manifold FE 35 3/8 Brass
- 62202** Exhaust Manifold Stud 35 FE 3/8 UNC

Part no	Dimensions	Diameter
3066	38 mm	8mm
3283	41 mm	10mm
3067	45 mm	10mm
4137	51 mm	10mm
1327	54 mm	10mm
1326	57 mm	10mm
1633	64 mm	10mm
1637	66 mm	8mm
51203	70 mm	10mm
51201	80 mm	10mm
51202	92 mm	10mm

















- 61479** Exhaust 20 TVO Extension Horizontal (2 Hole)

Gasket = 3064

- 61299** Exhaust 35 135 Extension Horizontal

Gasket = 827877

Exhaust Manifolds

 <p>4687 Exhaust Manifold Ford Dexta Gasket=0490481</p>	 <p>0490481 Dexta Exhaust Manifold Gasket</p>	 <p>41335 Exhaust Manifold Ford Major (Year 4/57-1964) (Staggered Holes) Gasket=41219 Bolt=62202 Nut=62298</p>  <p>41219 Fordson/Super Major Inlet Manifold Gasket Set</p>
 <p>41233 Exhaust Manifold Ford Major - In Line Holes Gasket=42072 Bolt=62202 Nut=62298</p>	 <p>42072 Exhaust Manifold Gasket Ford Major</p>	 <p>41057 Exhaust Elbow Major Gasket=41469</p>  <p>41469 Exhaust Elbow Gasket Super Major</p>  <p>41218 Air Inlet Manifold Gasket 35 Dexta / Super De</p>
 <p>2149 Exhaust Manifold Ford 3000 4000 Gasket=1173 & 1173S</p>	 <p>1173 3 Cylinder Exhaust Manifold Gasket</p>  <p>1173S STEEL 3 Cylinder Exhaust Manifold Gasket</p>	 <p>2933 Exhaust Manifold Ford 4610 Gasket=1173 & 1173S</p>
 <p>41357 Exhaust Manifold Ford 6600 6610 Gasket=1174 & 4121</p>	 <p>1174 4 Cylinder Exhaust Manifold Gasket</p>  <p>4121 STEEL Exhaust Manifold Gasket Ford 5600 6600</p>	 <p>2150 Exhaust Manifold Ford 5000 Gasket=1174 & 4121</p>

Exhaust Manifolds



Gasket
41555



43191
Exhaust Manifold Kit Ford 7840
** Short and Long Side ** TS115 6 Cylinder 8240 8340



409734 STEEL Exhaust Manifold Gasket Ford New Type 3 & 6 Cylinder



409734R
Exhaust Manifold Gasket

1030
Exhaust Manifold Ford TW 10 60
Rear TW10 20 30 From '76 TW5
15 25 35 From '83
Gasket=1173 & 1173S



2365
Gasket Ford 7810 Exhaust Manifold Turbo
Also fits TW 8210 Front+



2353
Exhaust Manifold Ford 7810 8210 TW Turbo TW10
TW20 TW30 From 76 TW5 15 25 35 From '83
Gasket=2365

1173 / 1173S
3 Cylinder Exhaust Manifold Gasket



43151
Gasket Exhaust Manifold New Holland T6020 - T6080 [OE Ref: 2853800](#)

43272
Exhaust Manifold Ford New Holland 4230 4835 5635 L65 L75
TL100 TL70 TL80 TL90 Fiat 65-66 70-66 80-66 80-76 65-93
72-93 82-93 550 600
[OE Ref: 04606570](#)



Cooling System Pumps



48823
Water Pump Ford 2N 8N 9N
c/w Pulley



41226
Water Pump Ford Dexta &
Super Dexta



3227
Water Pump Major



41477
Water Pump Pulley Super
Major



4057
Water Pump Ford 6600 7600 Double
Pulley Includes the Gaskets
** for Tractors WITHOUT Viscous Fan
**



2830
Water Pump Ford 10s
** for Tractors with Viscous Fan **
** 4057 is for Tractors WITHOUT
Viscous Fan *

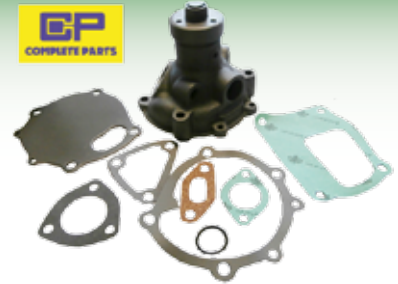

42911
Water Pump Ford 35 Series L
TL TN

42916
Water Pump Ford
1720 1920 3415
LS150 LS160 LS170
LX465 LX565
LX665 TC30D
TC33D TC35D
TC40D TC45D
TC48TD TC55D



42913
Water Pump Ford
1910 2110 2120



42914
Water Pump
Ford 1500
1700 1900



1922
Water Pump Ford 2000 3000
4000 Single Pulley 5000 6600



2449
Water
Pump
Ford 7810
Only



42915
Water Pump Ford 1710



1402
Water Pump Gasket Ford (Inside)



1398
Water Pump Gasket Ford
Dexta/2-5000



Cooling System Pumps



403540
Water Pump Ford 7840 - 8340
Side Stud 7740 7840 8240
8340 ts90-120 Genesis Pump

Gasket=1402



403539
Water Pump Ford 7840 -
8340 TS - Front Stud

Gasket=1402



41032
Water Pump New
Holland Combine
8060 8055

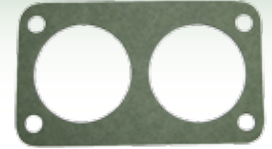

41871
Thermostat Gasket Ford
TM TW G 70 Series



409675
Water Pump Ford TM 115
- TM165 8160 - 8560 UP
06/2002 - 117mm Impeller
**Note has Small Impeller **



41029
Water Pump Case Maxxum
MX Cummins Engine New
Holland TSA / T Series
148mm Centre Hole 78mm
Impeller



41697
Water Pump Ford TM120 -
TM190 New Type 127mm
Impeller c/o O Ring -
From 06/02



4728
Water Pump Ford 8210
TW10 TW15 TW20 TW30
145mm Pulley



41869
Pulley Ford TM115 - TM190 Fan Belt
Tensioner 8160 - 8560 M100 - M160
** Tensioner is 404858 **



409673
Water Pump Plug Ford
TM115 - TM165



4922
Water Pump
Gasket Ford 40's

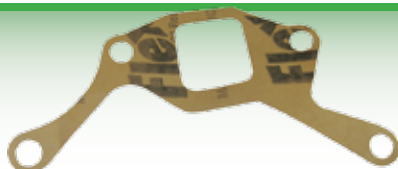

42251
Gasket Ford 5640 6640 7740 7840
Water Pump 8240 8340 TS100 TS110
TS80 TS90



409674
Water Pump Cover Gasket
Ford TM 115-165



3486
Hydraulic Pump O
Ring Large



409661
Water Pump Gasket Ford 40
TM TS90 - TS115

41049
Water Pump Back
Housing Ford 40
60 M TM TS ** Kit
43189 **



4923
Water Pump Gasket
Ford 40's

Cooling System

Fan Belts & Parts

Part No.	Models	Description	Dimensions
1936	Dexta & Major	Cogged	12.5 X 1125
2275	2000 3000 4000 5000		13 X 1375
3790	200 500 10's 100's		13 X 1400
2240	7600	Double Pulley	13 X 1225
3370	66/76	Alternator Belt Double Pulley	13 X 765
4423	76/7610	Double Pulley Main Belt	
4456	76/7610/7810	Short	13x800
4254	7810 Late	Long	13 X 1150
4794	8210 TW5 10 15 20		13 X 1470



40's/TS

Part No.	Models	Description
402914G	40 TS 110 TS115 6PK2217	w/o Air Con Original
402915G	40 TS110 TS115 6PK2554	c/w Air Con Original
404857	TS 80 90 100	w/o Air Con 6PK2228
404857G	TS 80 90 100	w/o Air Con 6PK2225

TM

Part No.	Models	Description
404859G	8100 8200 8300 8560	8PK1475
41051G	8160 8260 8560 M	8PK1951
43207	Fan Belt Ford TM120 130 140 155 175 190	8PK2030

TSA

Part No.	Models	Description
41635	TSA 100-135 T6000	8PK1551
41635G	TSA 100-135 T600	8PK1551
41636	TSA 100-135 & T6000	c/w Air Con

TL

Part No.	Models	Description
43128	TLA T4 T5	8PK1381

Cooling System

Pulleys



3323
Idler Pulley Assembly Ford 7610
7810 7610 4 Cyl 1981-91, 7810 6
Cyl 1988-91



42092
Pulley Idler Pulley Ford 7610
7810 7610 4cyl
Part Of 3323



41157
Bearing to suit 42092 &
2953 Pulley



42093
Back Plate Idler Pulley
Ford 7610 7810 7610
Part Of 3323



42090
End Cap Idler Pulley Ford 7610
7810 7610 4cyl
Part Of 3323



42089
Ring Clip Idler Pulley Ford
7610 7810 7610
Part Of 3323



4895
Pulley Bearing Assembly
Ford TW



2953
Pulley Ford 7600 Idler Pulley
Assembly 7600 7700 6600 from
1975-81 3 Cylinder



42091
Snap Ring Idler Pulley
Ford 7610 7810 7610
Part Of 3323



4145
Thermostat Housing Ford 2 - 7610
2000 3000 4000 5000 6000 70002600
3600 4600 5600 6600 7600



3863
Thermostat Gasket Ford - All
Models



43245
Thermostat Air Conditioning
Switch Ford NewHolland T6010 -
T6080 T7030 - T7060 TS100A TS110A
TS115A TS125A Case Maxxum 100 -
140OE Ref:84240633

Gasket = 3863

Cooling System

Air Conditioning Ford TM



42187
Compressor Ford TM Air Conditioning 8160 8260 8560 M100 M115 M135 M160 TM115 TM120 TM125 TM130 TM135 TM140 TM150 TM1
OE Ref: 87709786

43033
Compressor Ford 4340 5340 5640 6640 7740 7840 8240 8340 TS100 TS110 TS115 TS90 8340 Turbo



43158

Compressor Air Conditioning Ford 40 Series
OE Ref: 82001879



43161

Compressor Air Conditioning Ford 35 Series TD Series TL Series Case IH JX Series Fiat 86 Series 94 Series L Series
OE Ref: 5165549



52232

Compressor Case IH 140 Maxxum 100 MXU100 MXU110 MXU115 MXU125 MXU130 MXU135 Maxxum140Ford TS100A TS110A TS115A TS125A TS130A



43159
Receiver Dryer Ford 40s 60s TMs TSs Fiat M Series
OE Ref: 82007131



42189
Filter Drier Ford TM Air Conditioning
OE Ref: 82023593



43160
Blower Motor Assembly Ford 35 Series TL Series Fiat L Series
OE Ref: 82002761



43162
Blower Motor Ford 10 Series 100 Series 5610 6610 7610 7710 7810 8210 3600 4600 5600 6600 6700 7600 7700
OE Ref: 86010530



43163
Blower Switch Ford 10s 3600 4600 - 7700 8530 - 8830 5640 - 8340 8160 TL100 TL80 TL90 TMs TS100 TS110 TS115 TS90 TWs Deutz Agrotion
OE Ref: 83907434



43040
Blower Switch Ford 40 Series 60 Series TD Series TM Series TS Series Fiat M Series Case



43039
Thermostatic Switch Ford 40 Series 60 Series TM Series TS Series Fiat M 100 115 135 160

42188
Valve Expansion Air Conditioning Ford TM Also fits Ford 40 60 TS
OE Ref: 82000932



43035
Valve Expansion Ford 4635 4835 5635 6635 7635 TL TLA TN TSA Series Fiat F Series Case JX70U JX80U JX90U 3050 3060 3065 5445 5455 5465



53109
Air Vent 169 x 62 x 12mm
Cut Out 146 x 44mm



42190
Air Vent CNH JCB 143 x 52 x 27mm
Cut Out 132 x 49mm



62846
Air Vent 280 x 235mm
Cut Out 261 x 225mm
CX & Massey Ferguson



62847
Air Vent 390 162 x 35 x 20mm
Cut Out 150 x 32mm



53110
Air Vent Round 100mm No Spigots
Outer Diameter 100mm
Cut Out 100mm
76.5mm



53111
Air Vent Round 100mm c/o 65mm Spigot
Outer Diameter 100mm
Cut Out 76.5mm

Cooling System

Radiator Cowls



41593
Radiator Cowl Ford
3000 3610 2000
3000 4000



41594
Radiator Cowl Ford
5000 6600 16"



41595
Radiator Cowl Ford
6610 1981 - 1991
No Air/Con



41851
Radiator Cowl Ford
6610 7610 17" blade



3905
Fanblade 200 300 3600
500 Plastic 8 Blade



2256
Fanblade Ford 5600 - 7600
7700 6 Blade 6410 - 6610



4358
Fanblade Ford 7610 7
Blade 17" - Early



1320
Fanblade Ford
TW15 - 6 Blade



1306
Fanblade Ford
TW20 30 & Old
97s 22"

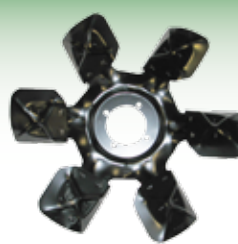

41894
Fanblade Ford 40
TS115 4 Cylinder



42136
Fanblade Ford TM 120 130
140 20 x 16 Mechanical
Transmission



42147
Fanblade
Ford TM



409711
Water Pump
Spacer Ford
7600 - 1922
Water Pump
To replace
Viscous



404891
Water Pump
Spacer Ford
5610 6610 **
1922 is Pump

Cooling System Parts

Viscous Fans



2608
Viscous Fan
Unit Ford 7610



41117
Viscous Fan
Ford 7840



41118
Viscous Fan
Ford 8340 -
Clutch Type



Front



Back

42167
Viscous Fan Ford
TM140



43188
Viscous Fan Ford TM150
TM165 8560 CCLS TV140
Fiat M160 CCLS



43187
Viscous Fan Ford 8160 8260
8360 8560 TM115 TM125
TM135
Fiat M100 M115 M135
M160

Radiators



41501
Radiator Fordson
Dexta Standard



41559
Radiator Fordson
Super Dexta



4825
Radiator Ford 2000
3000 4000 - 4 Row



4826
Radiator Ford 5000 6600
- 4 Row



43017
Radiator Fixing Bolt Ford 3600 4600 5610 6610 7610 7710

Cooling System Parts

Radiators



41427
Radiator Major Standard & Power Core 435mm wide x 470mm high



41560
Radiator Super Fordson Major



4276R
Radiator Ford c/o Oil Cooler 6610 7600 7610



41627
Radiator Ford c/o Oil Cooler 7810 & Late 7610 7610 from 01/06/89 c/w A/C & Viscous Fan



43129
*** USE 43011 ***
Radiator Ford 8160 8260 8360 8560 M100 M160



43011
Radiator Ford 8160 8260 TM110 TM120 TM130 Fiat M100 M115 Includes Oil Cooler



41887
Radiator Ford 5640 6640 7740 - 4 Cylinder **Also early TS90 TS100**



41928
Radiator Ford 7840 - 8340 (6 Cylinder) **Also early type TS110 TS115**



1851095
Radiator Tap



41931
Radiator Ford TM140 TM155 Case MXM140 MXM 155 Cap = 42029



43013
Radiator TM150 TM165 Full Powershift Transmission 18x6 40KPH 4WD & 17x6 30KPH 2WD



41886
Radiator Ford TM175 TM190 Case MXM190



43001
Radiator Ford New Holland 5635 6635 7635 TK Series Crawlers TK100A TL Series TL100 TL80 TL90 TK90 Fiat L75 85 95 Case JX100 JX80U



43131
Radiator Ford T6010 T6020 T6030 TS100A TS135A
[OE Ref: 87306757](#)

Cooling System Parts

Thermostats



4398
Thermostat Ford 82 $\frac{1}{2}$ c/o Pin Case
CX70 80 90 3000 Series John Deere
40 Ford 40 60 M TM TS



4058
Thermostat Ford
78 $\frac{1}{2}$



3868
74°
Thermostat



48837
Thermostat
Fordson 2N
8N 9N 180 $\frac{1}{2}$

41216
Thermostat
Housing Fordson
Super Major
Gasket = 3863



Radiator Caps

4023
Radiator Cap
Ford 7lb



2083
Radiator Cap
Massey Ferguson &
Ford 10 Lb



4717
Radiator Cap
Ford 13 Lb

41805
Radiator Cap Fordson



48808
Radiator Cap Fordson N's
2N/8N/9N (1943-1952)



41228
Radiator Cap Fordson
Super Major



41877
Radiator Cap Ford TM120
- TM190



42029
Radiator Cap TM MXM **To Suit
Clancy Rads 41931 & 41886**



40's Cooling System

Fanbelt Less Air Conditioning

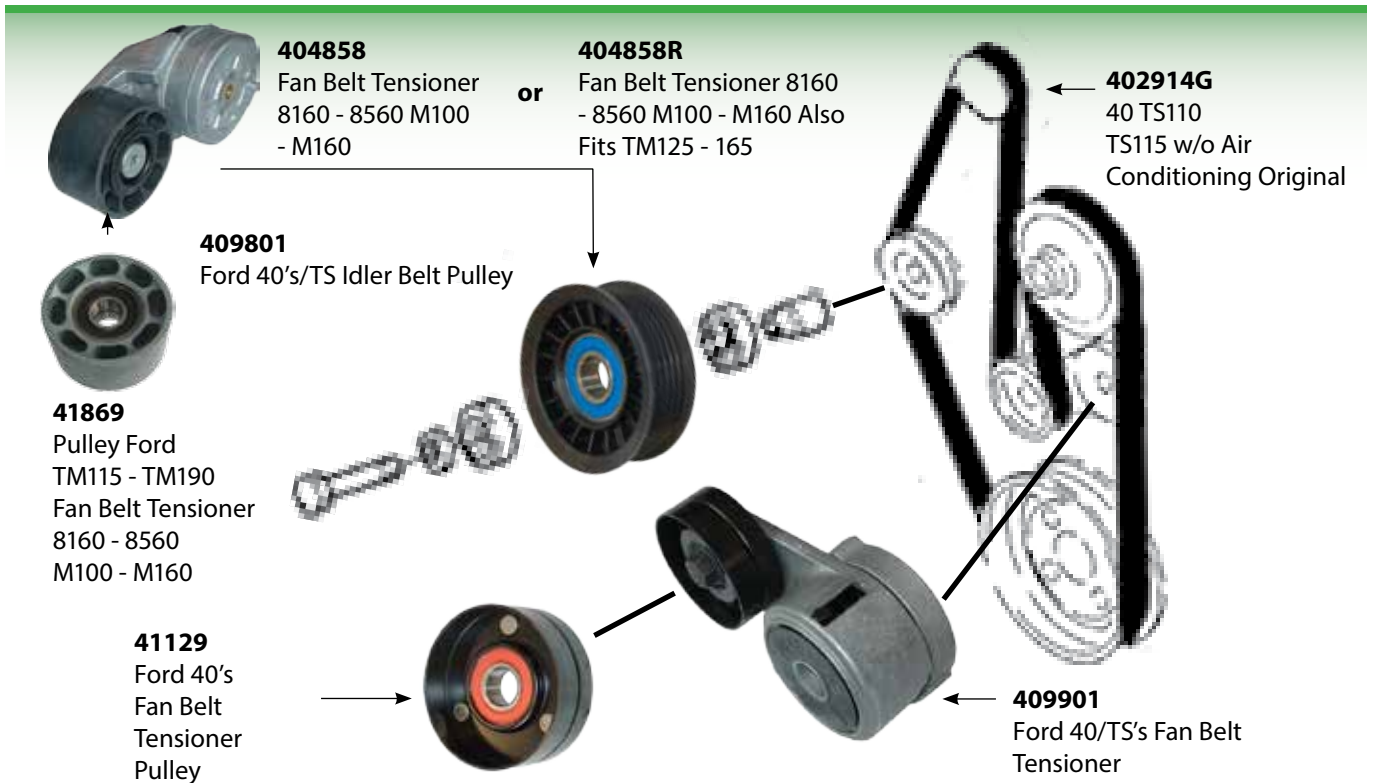

Fanbelt With Air Conditioning

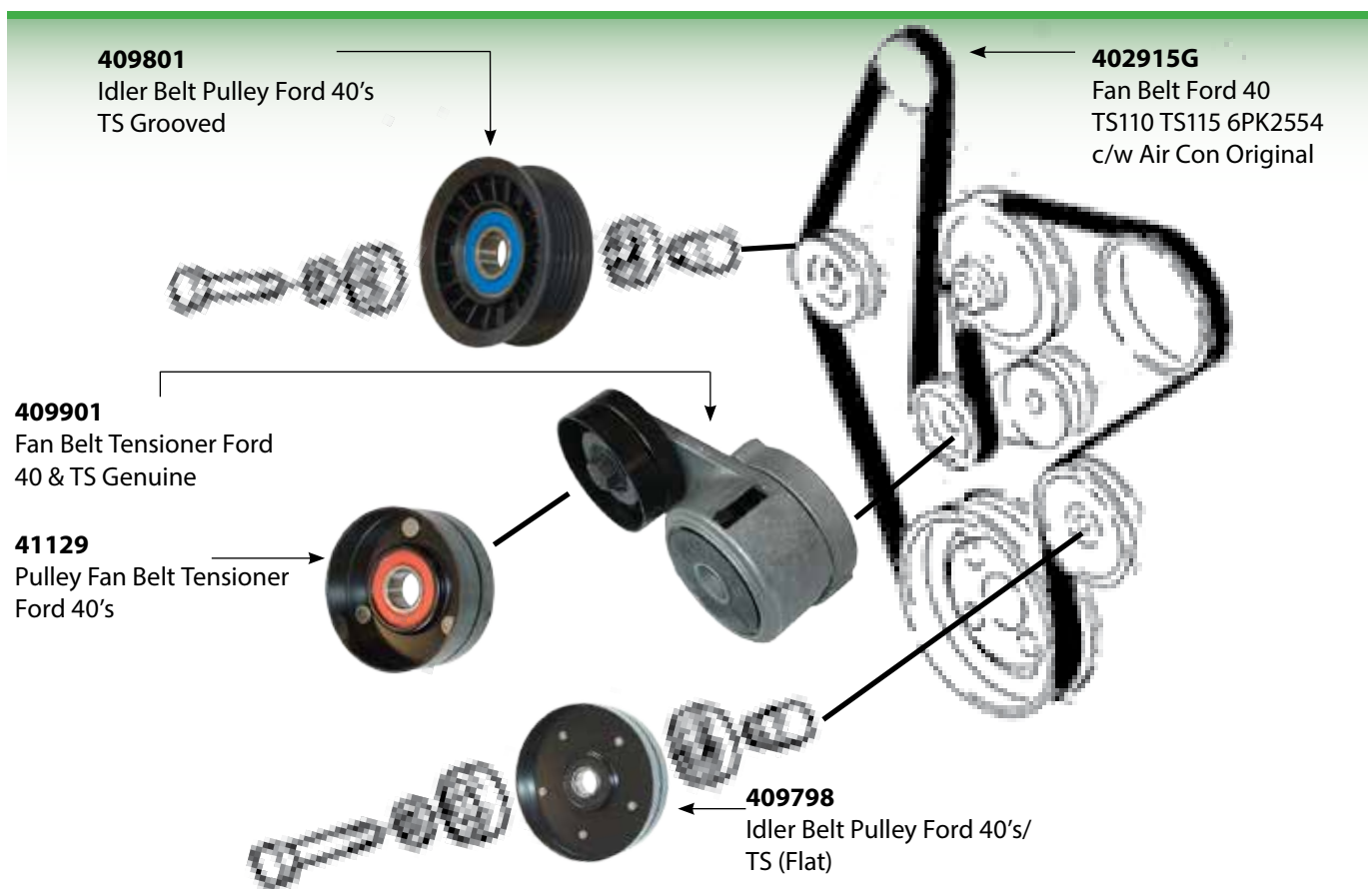

Hoses

Dexta

	<p>4053 Hose Radiator Ford Dexta Top (935)</p>		<p>1861746 Air Cleaning Hose 135 Dry 1438 Dexta Super Dexta</p>
<p>Hose Clips=2440</p>		<p>Hose Clips=2440</p>	

	<p>4054 Hose Ford Dexta Bottom (487) Dexta F3.144 and Super Dexta F3.152</p>		<p>41046 Hose Water Filler Dexta</p>
<p>Hose Clips=2440</p>		<p>Hose Clips=2440</p>	

Major Hoses

	<p>4055 Hose Radiator Major Power Super Top (310) 445</p>		<p>4056 Hose Major Bottom (311) Major - Super - Power</p>		<p>EIADKN8333 Hose Major Radiator Filler Hose Also fits Power Major & Super Major</p>
<p>Hose Clips=2440</p>		<p>Hose Clips=2426SS</p>		<p>Hose Clips=2440</p>	

	<p>41784 Water Filler Neck Bracket Major / Dexta Neck to suit 41049 Hose</p>		<p>41069 Hose ID 45MM OD 55MM Centre to Centre 220 Hose Clip 2413</p>		<p>41068 Hose Air Breather / Filter Major</p>
		<p>Hose Clips=2413SS</p>		<p>Hose Clips=2440</p>	

2/3/5/66/7610 Hoses

	<p>4051 Hose Radiator Ford 2000 3000 5000 66 7600 Top</p>		<p>4052 Hose Radiator Ford 5000 6600 Bottom (608)</p>		<p>4339 Hose Kit Ford 5000</p>
<p>Hose Clips=2413SS</p>		<p>Hose Clips=2440</p>			

Hoses

4/4600 Hoses



4050
Hose Radiator Ford 2000 4000
Bottom

Hose Clips=2440

4338
Hose Kit Ford 4000



10 Series Hoses



1731
Hose Radiator Ford 7810
Top
Hose Clips=2413SS



1742
Hose Radiator Ford 6810 7810
Bottom
Hose Clips=2426SS



41121
Hose Kit Ford 7610

2688
** USE 4052 **



Hose Clips=2440

4051
Hose Radiator Ford 2000
3000 5000 66 7600 Top
Hose Clips=2413SS



40's 4 Cylinder 40's 4 & 6 Cylinder

40's 6 Cylinder



41009
Hose Radiator Ford
40 TS Top 4 Cylinder
Hose Clips=2426SS



404988
Hose Radiator Ford 5640
8340 Bottom
Also TS80 TS110 Hose
Clip 2440
Hose Clips=2440



42166
Hose Main to Aux Tank
Joiner Ford 40 Series



404989
Hose Radiator
Ford 40 Top 6
Cylinder
Hose Clips=2397



41876
Hose Ford TM120 -
TM155 Top Radiator
Hose Clips=2413SS



43060
Hose Radiator Ford TM120 TM130
TM140 TM155 TM140 TM155 TM175
TM190 Case MXM120
41876= Top one to suit



41845
Hose Top Ford 8530-8830
TW10-TW35
Hose Clips=2413SS

General Water Hoses

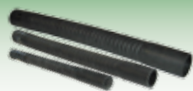

2603
1 1/4' X 17' Flexible Hose

2615
2' X 23' Flexible Hose

2609
1 1/2' X 19' Flexible Hose



Straight Hoses

4530	1" X 3
4531	1 1/8" X 3
4532	1 1/4" X 3
4533	1 3/8" X 3
4534	1 1/2" X 3
4535	1 3/4" X 3
4536	2 3/4" X 3

90° Bend Hoses

2596	1" (8" X 16")
2597	1 1/4" 90° (8" X 16")
2598	1 1/2" 90° (8" X 16")
2599	1 3/4" 90° (8" X 16")
2600	2" 90° (8" X 16")
2601	2 1/4" 90° (8" X 16")
2602	2 1/2" 90° (8" X 16")

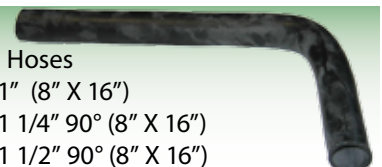

Hoses Clips

Original Type



Part No	Diameter (""")	Diameter (mm)
50999	5/16" - 15/32"	8-12
50998	3/8" - 5/8"	10-16
50997	15/32" - 3/4"	12-20
50996	5/8" - 1"	16-25
50995	23/32" - 1"	18-26mm
50992	7/8" - 1 3/16"	23-36
50991	1 27/64" - 1 39/64"	36-41mm
50990	1 21/32" - 1 27/32"	42-47mm
59089	1 49/64" - 1 31/32"	45-50mm
50988	1 5/16" - 2 3/8"	40-60mm
50986	2 3/8" - 3 3/16"	60-80
50985	2 3/4" - 3 1/2"	70-90

Standard Type



Part No	Diameter (mm)	TYPE
2340SS	9.5-12	Stainless Steel
2345SS	11-15	Stainless Steel
2346SS	12-20	Stainless Steel
2357	16-25	
2357SS	16-22	Stainless Steel
2364SS	18 - 25	Stainless Steel
2394	23-35	
2394SS	25- 35	Stainless Steel
2396	28-48	
2397SS	30 40	Stainless Steel
2413SS	35-50	Stainless Steel
2426SS	45-60	Stainless Steel
2440	50-70	
2440SS	55-70	Stainless Steel
2441SS	60-80	Stainless Steel
2443	70-90	
2443SS	70-90	Stainless Steel

Small Hose Clips

Part No	Diameter (mm)
59659	11
59660	13
59658	14
59661	17



Heavy Duty Clamp

Part No	Diameter (mm)
51934	122 - 130
51933	113 - 121



SOLTRON



52814 50ml **52815** 125ml **52816** 500ml **52817** 1 Litre

Part No.	ML	Initial Treatment 1:2,500	Refills 1:5,000
52814	50	125 Litres	250 Litres
52815	125	312.5 Litres	625 Litres
52816	500	1,250 Litres	2,500 Litres
52817	1 Ltr	2,500 Litres	5,000 Litres

Application: For Petrol & Diesel Engines

Benefits:

- Eliminates diesel bugs
- Removes tank sludge
- Removes environmentally harmful emissions
- Reduces engine wear
- Improved fuel economy
- Saves money

Protect Your Investment

STANADYNE®

Fuel Additives



53489 250ml **53404** 500ml **53490** 5Ltr **53423** 25Ltr

Part No.	Size	Treats
53489	250 ml	125 litres
53404	500 ml	250 litres
53490	5 litres	2500 litres
53423	25 litres	12,500 litres

Application

- High pressure common rail
- Unit Injectors
- Rotary Distributor Pumps
- In-line pumps

Benefits

- Upgrades and stabilizes fuel by reducing sludge and fuel tank contaminants
- Cleans and protects fuel system components
- Removes varnish and other deposits to prevent plugging
- Helps remove water from fuel
- Regular use of Stanadyne can dramatically improve power, torque and miles per gallon, while reducing smoke and other harmful emissions
- Recommended by engine and vehicle manufacturers including John Deere
- Performance formula can reduce particulate emissions by up to 49%

4-239D Engine

300 Series 239 inches 4 Cylinders

Replacement Parts Suitable for

JOHN DEERE TRACTORS

Engine Overhaul Kits

	Part No.	Description	92000 Standard Overhaul Kit	92010 .010" Kit	92020 .020" Kit	Bore
1	QRE30250	Cylinder Kit*	4	4	4	106.5
1A	QAR65507	O Ring Kit	4	4	4	
2	QRE501579	Gasket Set	1	1	1	
3	QAR67942	Seal Front	1	1	1	
4	QR78598	Thrust Washer for Flange-less Bearing	4	4	4	
5	QR57160	Balance Bush	6	6	6	
6	QR55647	Rod Bush	4	4	4	
7	QRE44574	Seal Rear	1	1	1	
8	QAR81786	Thrust Bearing STD	1			
9	QRE27348	Rod Bearing STD	4			
10	QRE27352	Main Bearing STD	4			
11	QAR81788	Thrust Bearing 10 Thou		1		
12	QRE27349	Rod Bearing 10 Thou		4		
13	QRE27353	Main Bearing 10 Thou		4		
14	QAR81789	Thrust Bearing 20 Thou			1	
15	QRE27358	Rod Bearing 20 Thou			4	
16	QRE27360	Main Bearing 20 Thou			4	



*Head Set QRE38851 Contains		
R73521-B	Gasket, Rocker Cover, 4 Cyl	1
R97354-B	Gasket, Inj Pump Mount	1
R105346-B	Gasket, Turbo Oil Outlet	1
R97348-B	Gasket, Turbo Oil Inlet	1
R89879-B	Gasket, Turbo Mount	1
R56463-B	O-Ring, Vent Tube Outlet	1
R54641-B	Gasket, Thermostat to Cyl Head	1
R54638-B	Gasket, Thermostat Cover, Dual	1
R48000	Seal, Pencil Injector	4
R90658	Gasket, Exhaust Manifold	4
R87627	O-Ring, Valve Stem	8
R81275	Gasket, Air Inlet	1
R60746	Seal, Pencil Injector	4
T20219	Gasket, Thermostat Housing	1
PM-771	Bag, 6X8 Plain, Sharp	1
NT20215	Gasket, Thermostat Cover	1
R125863-B	Gasket, Cyl Head, 4 Cyl,	1
**Oil Pan Set QRP341 Contains		
R74354	O-Ring	1
R75892	O-Ring, Oil Supply Tube	1
R77052	O-Ring	2
R79563	Sleeve, Rubber	1
R97342	Gasket, Oil Pan, 4 Cyl,	1

***Conversion Set QRP682 Contains			
A4730R	O-Ring, Oil Pump Intake	1	
R116025	Gasket, Water Pump Mount	1	
R495R	O-Ring, Ventilator Tube	1	
R52811	O-Ring, Inlet, Outlet	1	
R56192	O-Ring, Oil Cooler, Inner	1	
R56193	O-Ring, Oil Cooler, Outer	1	
R56461	O-Ring, Thermostat/Water Tube	1	
R56814	O-Ring, Oil Cooler to Housing	1	
R56815	O-Ring, Oil Cooler to Cooler	1	
R61871	O-Ring	1	
R70956	Packing, Oil Cooler	1	
R74354	O-Ring	1	
R75892	O-Ring, Oil Supply Tube	1	
R77052	O-Ring	2	
R79551	Gasket, Oil Cooler Cover	1	
R90648	Gasket, Block to End Plate	1	
R97346	Gasket, Water Line	1	
R97350	Gasket, Fuel Transfer Pump	1	
R97351	Gasket, Flywheel Housing	1	
R97352	Gasket, Oil Filler Inlet	1	
R97454	Gasket, Timing Gear Cover	1	
R97773	Gasket, Cover	1	
R98484	Gasket, Oil Cooler	1	
R98485	Gasket, Oil Cooler, Lower	1	
R98485	Gasket, Oil Cooler, Lower	1	
R98486	Gasket, Oil Cooler	2	
R98487	Gasket, Oil Cooler, Lower	1	
R98488	Gasket, Oil Filter Adapter	1	
R98489	Gasket, Oil Cooler to Cyl	1	
R98834	Gasket, Oil Cooler to Cyl	1	
T13213	Washer, Oil Drain Plug	1	
T20273	Gasket, Timing Gear Cover	1	
T20328	Gasket, Oil Filler Cap	1	
T23132	Gasket, Water Inlet	1	
U13639	O-Ring, Coolant Heater Plug	1	

Rod Bolts

Part No.	Description	Qty.	Note
QR74194	Rod Bolt	12	For Con Rods Marked: R51727, R58979 (54mm Long)
QR80033	Rod Bolt Long	12	For Con Rods Marked: R80032, R80034, R113612 (59mm Long)

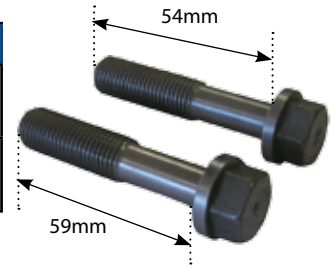

Gaskets

Gaskets			
	Part No.	Description	Qty.
1	QRE38851*	Head Set	1
2	QRP341**	Oil Pan Set	1
3	QRP682***	Conversion Set	1

59242 Sump Set

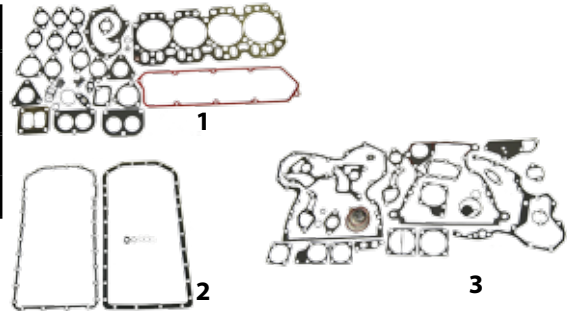

Valve Kit

Valve Kit 59237 Contains			
	Part No.	Description	Qty.
1	QR79623	Valve, Intake	4
2	QR79624	Valve, Exhaust	4
3	QR51734	Valve Seat, Exhaust	4
4	QRP223	Valve Seat, Intake	4
5	QR41412	Retainer, Valve Spring, Intake & Exhaust	8
6	QRE11410	Rotator, Intake & Exhaust	8
7	QR26125	Spring, Valve, Intake & Exhaust	8
8	QT20077	Lock, Valve, Intake & Exhaust	16
9	QT20129	Cap, Valve Stem	8
10	QR87627	O-Ring, Valve Stem	8



Ring Sets, Con Rods & Balancer Shafts

	Part No.	Description
1	QRE66820	Ring Sets
2	QRE21076	Con Rod
3	QAR61351	Balancer Shaft Right
4	QAR61352	Balancer Shaft Left

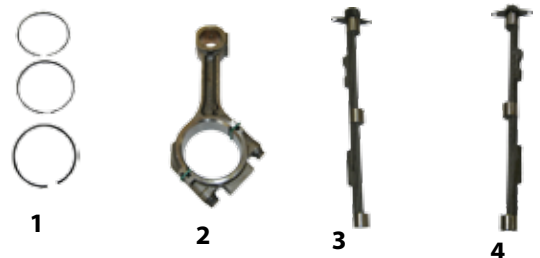

Camshaft, Tappet & Oil Cooler

	Part No.	Description
1	QR82820	Camshaft
2	QT20073	Tappet (8)
3	QRE31929	Oil Cooler



4-239T Turbo Engine

300 Series 239 inches 4 Cylinders

Engine Overhaul Kits

	Part No.	Description	91500 Standard	91510 .010"	91520 .020"
1	QRE33115	Cylinder Kit	4	4	4
1A	QAR65507	O Ring Kit	4	4	4
2	QRE501579	Gasket Set* Contains: Head Set QRE38851 Oil Pan Set QRP341 Conversion Set QRP682	1	1	1
3	QAR67942	Seal Front	1	1	1
4	QR78598	Thrust Washer for Flange-less Bearing	4	4	4
5	QR57160	Balance Bush	6	6	6
6	QR57451	Rod Bush	4	4	4
7	QRE44574	Seal Rear	1	1	1
8	QAR81786	Thrust Bearing STD	1		
	QAR81788	Thrust Bearing 10 Thou		1	
	QAR81789	Thrust Bearing 20 Thou			1
9	QRE27348	Rod Bearing STD	4		
	QRE27349	Rod Bearing 10 Thou		1	
	QRE27358	Rod Bearing 20 Thou			1
10	QRE27352	Main Bearing STD	4		
	QRE27353	Main Bearing 10 Thou		1	
	QRE27360	Main Bearing 20 Thou			1

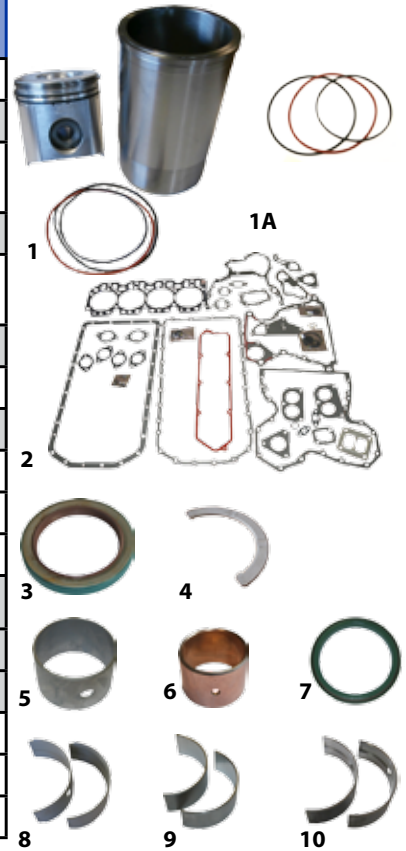

*Gasket Set

Head Set QRE38851 Contains			Conversion Set QRP682 Contains					
R73521-B	Gasket, Rocker Cover, 4 Cyl	1	A4730R	O-Ring, Oil Pump Intake	1	R98485	Gasket, Oil Cooler, Lower	1
R97354-B	Gasket, Inj Pump Mount	1	R116025	Gasket, Water Pump Mount	1	R98486	Gasket, Oil Cooler	2
R105346-B	Gasket, Turbo Oil Outlet	1	R495R	O-Ring, Ventilator Tube	1	R98487	Gasket, Oil Cooler, Lower	1
R97348-B	Gasket, Turbo Oil Inlet	1	R52811	O-Ring, Inlet, Outlet	1	R98488	Gasket, Oil Filter Adapter	1
R89879-B	Gasket, Turbo Mount	1	R56192	O-Ring, Oil Cooler, Inner	1	R98489	Gasket, Oil Cooler to Cyl	1
R56463-B	O-Ring, Vent Tube Outlet	1	R56193	O-Ring, Oil Cooler, Outer	1	R98834	Gasket, Oil Cooler to Cyl	1
R54641-B	Gasket, Thermostat to Cyl Head	1	R56461	O-Ring, Thermostat/Water Tube	1	T13213	Washer, Oil Drain Plug	1
R54638-B	Gasket, Thermostat Cover, Dual	1	R56814	O-Ring, Oil Cooler to Housing	1	T20273	Gasket, Timing Gear Cover	1
R48000	Seal, Pencil Injector	4	R56815	O-Ring, Oil Cooler to Cooler	1	T20328	Gasket, Oil Filler Cap	1
R90658	Gasket, Exhaust Manifold	4	R61871	O-Ring	1	T23132	Gasket, Water Inlet	1
R87627	O-Ring, Valve Stem	8	R70956	Packing, Oil Cooler	1	U13639	O-Ring, Coolant Heater Plug	1
R81275	Gasket, Air Inlet	1	R74354	O-Ring	1			
R60746	Seal, Pencil Injector	4	R75892	O-Ring, Oil Supply Tube	1			
T20219	Gasket, Thermostat Housing	1	R77052	O-Ring	2			
PM-771	Bag, 6X8 Plain, Sharp	1	R79551	Gasket, Oil Cooler Cover	1			
NT20215	Gasket, Thermostat Cover	1	R90648	Gasket, Block to End Plate	1			
R125863-B	Gasket, Cyl Head, 4 Cyl,	1	R97346	Gasket, Water Line	1			
Oil Pan Set QRP341 Contains			R97350	Gasket, Fuel Transfer Pump	1			
R74354	O-Ring	1	R97351	Gasket, Flywheel Housing	1			
R75892	O-Ring, Oil Supply Tube	1	R97352	Gasket, Oil Filler Inlet	1			
R77052	O-Ring	2	R97454	Gasket, Timing Gear Cover	1			
R79563	Sleeve, Rubber	1	R97773	Gasket, Cover	1			
R97342	Gasket, Oil Pan, 4 Cyl,	1	R98484	Gasket, Oil Cooler	1			

Rod Bolts

Part No.	Description	Qty.	Note
QR74194	Rod Bolt	12	For Con Rods Marked: R51727, R58979 (54mm Long)
QR80033	Rod Bolt Long	12	For Con Rods Marked: R80032, R80034, R113612 (59mm Long)

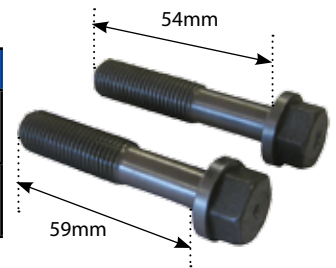

Gaskets

	Part No.	Description	Qty.
1	QRE38851	Head Set	1
2	QRP341	Oil Pan Set	1
3	QRP682	Conversion Set	1
4	QRP341+ QRP682	Sump Set	1

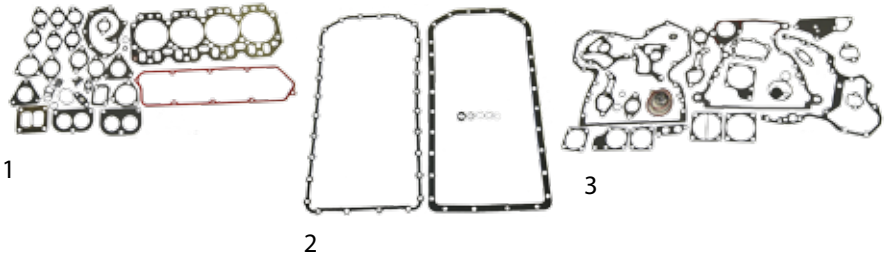

Valve Kit

Valve Kit 59239 Contains

	Part No.	Description	Qty.
1	QR83071	Valve, Intake	4
2	QR79624	Valve, Exhaust	4
3	QR51734	Valve Seal, Exhaust	4
4	QR73064	Valve Seal, Intake	4
5	QR41412	Retainer, Valve Spring, Intake & Exhaust	8
6	QRE11410	Rotator, Intake & Exhaust	8
7	QR26125	Spring, Valve, Intake & Exhaust	8
8	QT20077	Lock, Valve, Intake & Exhaust	16
9	QT20129	Cap, Valve Stem	8
10	QR87627	O-Ring, Valve Stem	8



Ring Sets, Con Rods & Balancer Shafts

	Part No.	Description
1	QRE66820	Ring Sets
2	QRE42733	Con Rod
3	QAR69710	Balancer Shaft Right (746, 398 ->)
4	QAR69711	Balancer Shaft Left (746, 398 ->)
5	QAR61351	Balancer Shaft Right (->746, 397)
6	QAR61352	Balancer Shaft Left (->746, 397)

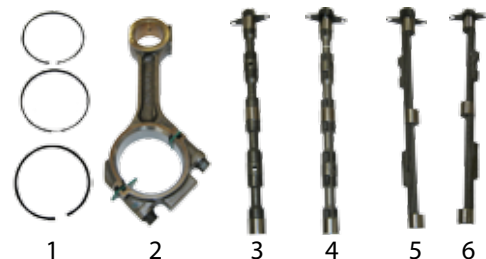

Camshaft, Tappet & Oil Cooler

	Part No.	Description
1	QR82820	Camshaft
2	QT20073	Tappet (8)
3	QRE31929	Oil Cooler



6-359D Engine

300 Series 359 inches 6 Cylinders

Engine Overhaul Kits

	Part No.	Description	93000 Standard Overhaul Kit	93010 .010" Kit	93020 .020" Kit	Bore
1	QRE30250	Cylinder Kit	6	6	6	106.5
1A	QAR65507	O Ring Kit	6	6	6	
2	QRE501580	Gasket Set	1	1	1	
3	QAR67942	Seal Front	1	1	1	
4	QR78598	Thrust Washer for Flange-less Bearing	4	4	4	
5	QR119874	Cam Bush	1	1	1	
6	QR55647	Rod Bush	6	6	6	
7	QRE44574	Seal Rear	1	1	1	
8	QAR81786	Thrust Bearing STD	1			
9	QRE27348	Rod Bearing STD	6			
10	QRE27352	Main Bearing STD	6			
11	QAR81788	Thrust Bearing 10 Thou		1		
12	QRE27349	Rod Bearing 10 Thou		6		
13	QRE27353	Main Bearing 10 Thou		4		
14	QAR81789	Thrust Bearing 20 Thou			1	
15	QRE27358	Rod Bearing 20 Thou			6	
16	QRE27360	Main Bearing 20 Thou			4	

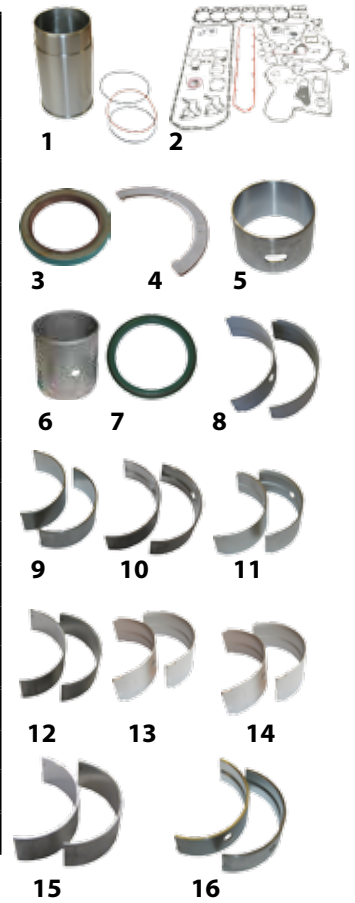

*Head Set QRE38852 Contains		
R114157-B	Gasket, Cyl Head, 6 Cyl,	1
R75728-B	Gasket, Rocker Cover, 6 Cyl	1
T24932	Gasket, Thermostat Cover	1
T23002	Gasket, Water Manifold Outlet	3
R60746	Seal, Pencil Injector	6
R56905	O-Ring, Air Intake	1
R81275	Gasket, Air Inlet	2
R87627	O-Ring, Valve Stem	12
R90658	Gasket, Exhaust Manifold	6
R48000	Seal, Pencil Injector	6
R97354-B	Gasket, Inj Pump Mount	1
R105346-B	Gasket, Turbo Oil Outlet	1
R97348-B	Gasket, Turbo Oil Inlet	1
R89879-B	Gasket, Turbo Mount	1
R56463-B	O-Ring, Vent Tube Outlet	1
R54641-B	Gasket, Thermostat to Cyl Head	1
R54638-B	Gasket, Thermostat Cover, Dual	

Oil Pan Set QRP343

**Conversion Set QRP682 Contains		
A4730R	O-Ring, Oil Pump Intake	1
R116025	Gasket, Water Pump Mount	1
R495R	O-Ring, Ventilator Tube	1
R52811	O-Ring, Inlet, Outlet	1
R56192	O-Ring, Oil Cooler, Inner	1
R56193	O-Ring, Oil Cooler, Outer	1
R56461	O-Ring, Thermostat/Water Tube	1
R56814	O-Ring, Oil Cooler to Housing	1
R56815	O-Ring, Oil Cooler to Cooler	1
R61871	O-Ring	1
R70956	Packing, Oil Cooler	1
R74354	O-Ring	1
R75892	O-Ring, Oil Supply Tube	1
R77052	O-Ring	2
R79551	Gasket, Oil Cooler Cover	1
R90648	Gasket, Block to End Plate	1
R97346	Gasket, Water Line	1
R97350	Gasket, Fuel Transfer Pump	1
R97351	Gasket, Flywheel Housing	1
R97352	Gasket, Oil Filler Inlet	1
R97454	Gasket, Timing Gear Cover	1
R97773	Gasket, Cover	1
R98484	Gasket, Oil Cooler	1
R98485	Gasket, Oil Cooler, Lower	1
R98485	Gasket, Oil Cooler, Lower	1
R98486	Gasket, Oil Cooler	2
R98487	Gasket, Oil Cooler, Lower	1
R98488	Gasket, Oil Filter Adapter	1
R98489	Gasket, Oil Cooler to Cyl	1
R98834	Gasket, Oil Cooler to Cyl	1
T13213	Washer, Oil Drain Plug	1
T20273	Gasket, Timing Gear Cover	1
T20328	Gasket, Oil Filler Cap	1
T23132	Gasket, Water Inlet	1
U13639	O-Ring, Coolant Heater Plug	1

Rod Bolts

Part No.	Description	Qty.	Note
QR74194	Rod Bolt	12	For Con Rods Marked: R51727, R58979 (54mm Long)
QR80033	Rod Bolt Long	12	For Con Rods Marked: R80032, R80034, R113612 (59mm Long)

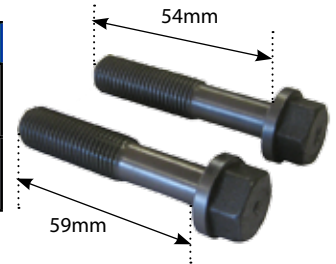

Gaskets

Gaskets			
	Part No.	Description	Qty.
1	QRE38852*	Head Set	1
2	QRP343	Oil Pan Set	1
3	QRP682**	Conversion Set	1

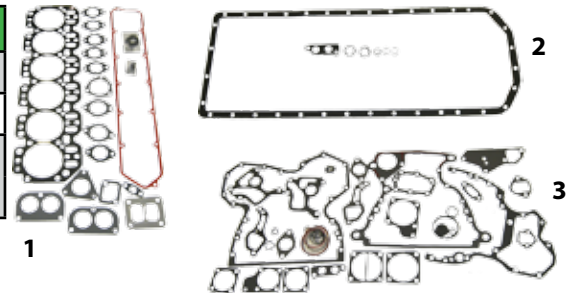

Valve Kit

Valve Kit 59236 Contains			
	Part No.	Description	Qty.
1	QR79623	Valve, Intake	6
2	QR79624	Valve, Exhaust	6
3	QR51734	Valve Seat, Exhaust	6
4	QRP223	Valve Seat, Intake	6
5	QR41412	Retainer, Valve Spring, Intake & Exhaust	12
6	QRE11410	Rotator, Intake & Exhaust	12
7	QR26125	Spring, Valve, Intake & Exhaust	12
8	QT20077	Lock, Valve, Intake & Exhaust	24
9	QT20129	Cap, Valve Stem	12
10	QR87627	O-Ring, Valve Stem	12



Ring Sets, Con Rod

	Part No.	Description
1	QRE66820	Ring Sets
2	QRE21076	Con Rod

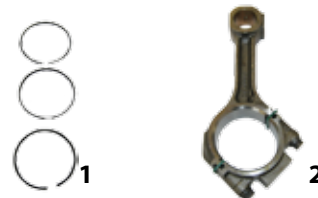

Camshaft, Tappet & Oil Cooler

	Part No.	Description
1	QR82821	Camshaft
2	QT20073	Tappet (8)
3	QRE31929	Oil Cooler

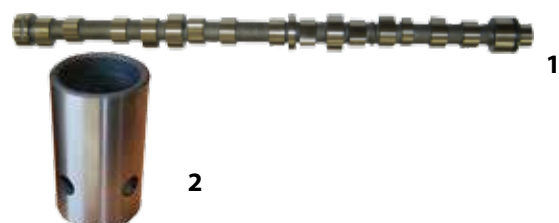

6359T Turbo Engine

300 Series 359 inches 6 Cylinders

Engine Overhaul Kits

	Part No.	Description	91000 Standard Overhaul Kit	91010 .010" Kit	91020 .020" Kit	Bore
1	QRE33115	Cylinder Kit	6	6	6	106.5
1A	QAR65507	O Ring Kit	6	6	6	
2	QRE501580	Gasket Set	1	1	1	
3	QAR67942	Seal Front	1	1	1	
4	QR78598	Thrust Washer for Flange-less Bearing	4	4	4	
5	QR57451	Rod Bush	6	6	6	
6	QRE44574	Seal Rear	1	1	1	
7	QAR81786	Thrust Bearing STD	1			
8	QRE27348	Rod Bearing STD	6			
9	QRE27352	Main Bearing STD	6			
10	QAR81788	Thrust Bearing 10 Thou		1		
11	QRE27349	Rod Bearing 10 Thou		6		
12	QRE27353	Main Bearing 10 Thou		6		
13	QAR81789	Thrust Bearing 20 Thou			1	
14	QRE27358	Rod Bearing 20 Thou			6	
15	QRE27360	Main Bearing 20 Thou			6	

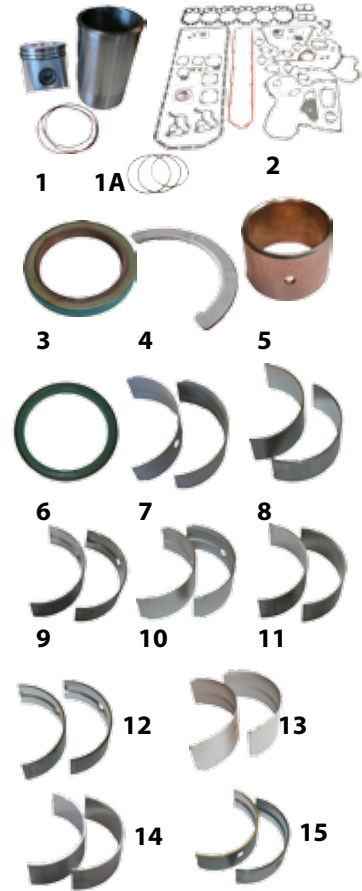

*Head Set QRE38852 Contains		
R114157-B	Gasket, Cyl Head, 6 Cyl,	1
R75728-B	Gasket, Rocker Cover, 6 Cyl	1
T24932	Gasket, Thermostat Cover	1
T23002	Gasket, Water Manifold Outlet	3
R60746	Seal, Pencil Injector	6
R56905	O-Ring, Air Intake	1
R81275	Gasket, Air Inlet	2
R87627	O-Ring, Valve Stem	12
R90658	Gasket, Exhaust Manifold	6
R48000	Seal, Pencil Injector	6
R97354-B	Gasket, Inj Pump Mount	1
R105346-B	Gasket, Turbo Oil Outlet	1
R97348-B	Gasket, Turbo Oil Inlet	1
R89879-B	Gasket, Turbo Mount	1
R56463-B	O-Ring, Vent Tube Outlet	1
R54641-B	Gasket, Thermostat to Cyl Head	1
R54638-B	Gasket, Thermostat Cover, Dual	

**Conversion Set QRP682 Contains		
A4730R	O-Ring, Oil Pump Intake	1
R116025	Gasket, Water Pump Mount	1
R495R	O-Ring, Ventilator Tube	1
R52811	O-Ring, Inlet, Outlet	1
R56192	O-Ring, Oil Cooler, Inner	1
R56193	O-Ring, Oil Cooler, Outer	1
R56461	O-Ring, Thermostat/Water Tube	1
R56814	O-Ring, Oil Cooler to Housing	1
R56815	O-Ring, Oil Cooler to Cooler	1
R61871	O-Ring	1
R70956	Packing, Oil Cooler	1
R74354	O-Ring	1
R75892	O-Ring, Oil Supply Tube	1
R77052	O-Ring	2
R79551	Gasket, Oil Cooler Cover	1
R90648	Gasket, Block to End Plate	1
R97346	Gasket, Water Line	1
R97350	Gasket, Fuel Transfer Pump	1
R97351	Gasket, Flywheel Housing	1
R97352	Gasket, Oil Filler Inlet	1
R97454	Gasket, Timing Gear Cover	1
R97773	Gasket, Cover	1
R98484	Gasket, Oil Cooler	1

R98485	Gasket, Oil Cooler, Lower	1
R98485	Gasket, Oil Cooler, Lower	1
R98486	Gasket, Oil Cooler	2
R98487	Gasket, Oil Cooler, Lower	1
R98488	Gasket, Oil Filter Adapter	1
R98489	Gasket, Oil Cooler to Cyl	1
R98834	Gasket, Oil Cooler to Cyl	1
T13213	Washer, Oil Drain Plug	1
T20273	Gasket, Timing Gear Cover	1
T20328	Gasket, Oil Filler Cap	1
T23132	Gasket, Water Inlet	1
U13639	O-Ring, Coolant Heater Plug	1

Oil Pan Set QRP343

Rod Bolts

Part No.	Description	Qty.	Note
QR74194	Rod Bolt	12	For Con Rods Marked: R51727, R58979 (54mm Long)
QR80033	Rod Bolt Long	12	For Con Rods Marked: R80032, R80034, R113612 (59mm Long)

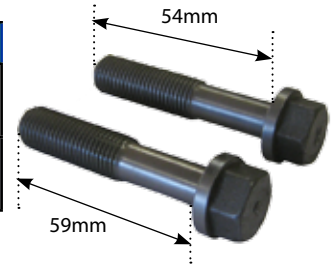

Gaskets

Gaskets			
	Part No.	Description	Qty.
1	QRE38852	Head Set*	1
2	QRP343	Oil Pan Set	1
3	QRP682	Conversion Set**	1
			} Sump Set

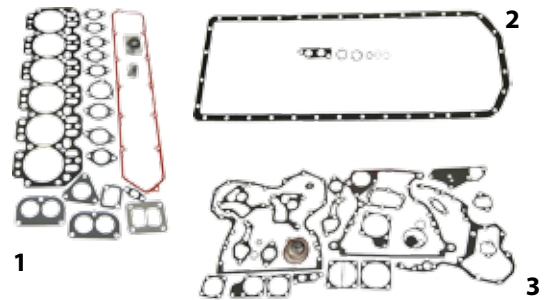

Valve Kit

Valve Kit 59238 Contains			
	Part No.	Description	Qty.
1	QR83071	Valve, Intake	6
2	QR79624	Valve, Exhaust	6
3	QR51734	Valve Seat, Exhaust	6
4	QR73064	Valve Seat, Intake	6
5	QR41412	Retainer, Valve Spring, Intake & Exhaust	12
6	QRE11410	Rotator, Intake & Exhaust	12
7	QR26125	Spring, Valve, Intake & Exhaust	12
8	QT20077	Lock, Valve, Intake & Exhaust	24
9	QT20129	Cap, Valve Stem	12
10	QR87627	O-Ring, Valve Stem	12



Ring Sets, Con Rods

Part No.	Description
1	QRE66820
2	QRE42733



Camshaft, Tappet & Oil Cooler

Part No.	Description
1	QR82821
2	QT20073
3	QRE31929



4039T Turbo Engine

300 Series 3.9 Litres 4 Cylinders

Engine Overhaul Kits

	Part No.	Description	90000 Standard	90010 .010"	90020 .020"
1	QRE33115	Cylinder Kit	4	4	4
1A	QAR65507	O Ring Kit	4	4	4
2	QRE501579	Gasket Set	1	1	1
3	QAR67942	Seal Front	1	1	1
4	QR78598	Thrust Washer for Flange-less Bearing	4	4	4
5	QR57160	Balance Bush	6	6	6
6	QR119874	Cam Bush	1	1	1
7	QR57451	Rod Bush	4	4	4
8	QRE44574	Seal Rear	1	1	1
9	QAR81786	Thrust Bearing STD	1		
10	QRE27348	Rod Bearing STD	4		
11	QRE27352	Main Bearing STD	4		
12	QAR81788	Thrust Bearing 10 Thou		1	
13	QRE27349	Rod Bearing 10 Thou		4	
14	QRE27353	Main Bearing 10 Thou		4	
15	QAR81789	Thrust Bearing 20 Thou			1
16	QRE27358	Rod Bearing 20 Thou			4
17	QRE27360	Main Bearing 20 Thou			4



* Head Set QRE38851 Contains		
R73521-B	Gasket, Rocker Cover, 4 Cyl	1
R97354-B	Gasket, Inj Pump Mount	1
R105346-B	Gasket, Turbo Oil Outlet	1
R97348-B	Gasket, Turbo Oil Inlet	1
R89879-B	Gasket, Turbo Mount	1
R56463-B	O-Ring, Vent Tube Outlet	1
R54641-B	Gasket, Thermostat to Cyl Head	1
R54638-B	Gasket, Thermostat Cover, Dual	1
R48000	Seal, Pencil Injector	4
R90658	Gasket, Exhaust Manifold	4
R87627	O-Ring, Valve Stem	8
R81275	Gasket, Air Inlet	1
R60746	Seal, Pencil Injector	4
T20219	Gasket, Thermostat Housing	1
PM-771	Bag, 6X8 Plain, Sharp	1
NT20215	Gasket, Thermostat Cover	1
R125863-B	Gasket, Cyl Head, 4 Cyl,	1
**Oil Pan Set QRP341 Contains		
R74354	O-Ring	1
R75892	O-Ring, Oil Supply Tube	1
R77052	O-Ring	2
R79563	Sleeve, Rubber	1
R97342	Gasket, Oil Pan, 4 Cyl,	1

*** Conversion Set QRP682 Contains					
A4730R	O-Ring, Oil Pump Intake	1	R98485	Gasket, Oil Cooler, Lower	1
R116025	Gasket, Water Pump Mount	1	R98485	Gasket, Oil Cooler, Lower	1
R495R	O-Ring, Ventilator Tube	1	R98486	Gasket, Oil Cooler	2
R52811	O-Ring, Inlet, Outlet	1	R98487	Gasket, Oil Cooler, Lower	1
R56192	O-Ring, Oil Cooler, Inner	1	R98488	Gasket, Oil Filter Adapter	1
R56193	O-Ring, Oil Cooler, Outer	1	R98489	Gasket, Oil Cooler to Cyl	1
R56461	O-Ring, Thermostat/Water Tube	1	R98834	Gasket, Oil Cooler to Cyl	1
R56814	O-Ring, Oil Cooler to Housing	1	T13213	Washer, Oil Drain Plug	1
R56815	O-Ring, Oil Cooler to Cooler	1	T20273	Gasket, Timing Gear Cover	1
R61871	O-Ring	1	T20328	Gasket, Oil Filler Cap	1
R70956	Packing, Oil Cooler	1	T23132	Gasket, Water Inlet	1
R74354	O-Ring	1	U13639	O-Ring, Coolant Heater Plug	1
R75892	O-Ring, Oil Supply Tube	1			
R77052	O-Ring	2			
R79551	Gasket, Oil Cooler Cover	1			
R90648	Gasket, Block to End Plate	1			
R97346	Gasket, Water Line	1			
R97350	Gasket, Fuel Transfer Pump	1			
R97351	Gasket, Flywheel Housing	1			
R97352	Gasket, Oil Filler Inlet	1			
R97454	Gasket, Timing Gear Cover	1			
R97773	Gasket, Cover	1			
R98484	Gasket, Oil Cooler	1			

Rod Bolts

Part No.	Description	Qty.	Note
QR80033	Rod Bolt Long	8	For Con Rods Marked: R80032, R80034, R113612 (59mm Long)



Gaskets

Gaskets			
	Part No.	Description	Qty.
1	QRE38851	Head Set*	1
2	QRP341	Oil Pan Set**	1
3	QRP682	Conversion Set***	1

59242 Sump Set

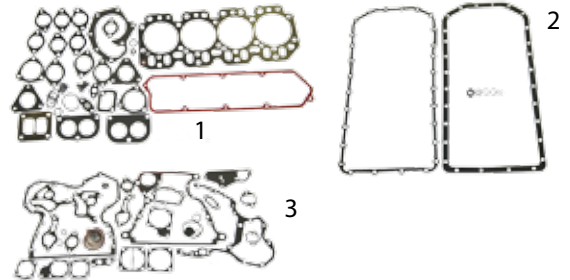

Valve Kit

Valve Kit 59240 Contains			
	Part No.	Description	Qty.
1	QR98062	Valve, Intake	4
2	QR90692	Valve, Exhaust	4
3	QR85687	Valve Seat, Exhaust	4
4	QR98063	Valve Seat, Intake	4
5	QRE60005	Rotator, Intake & Exhaust	8
6	QR26125	Spring, Valve, Intake & Exhaust	8
7	QR91889	Lock, Valve, Intake & Exhaust	16
8	QRE31617	Cap, Valve Stem	8



Ring Sets, Con Rods & Balancer Shafts

Part No.	Description
1	QRE66820
2	QRE42733

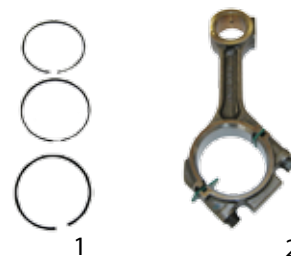

Camshaft, Tappet & Oil Cooler

Part No.	Description
1	QR82820
2	QT20073
3	QRE31929



4045T Turbo Engine

300 Series 4.5 Litres 4 Cylinders

Engine Overhaul Kits

	Part No.	Description	94000 Standard Overhaul Kit	94010 .010" Kit	94020 .020" Kit
1	QRE53073	Cylinder Kit Bore=106.5	4	4	4
1A	QAR65507	O Ring Kit	4	4	4
2	QRE501568	Gasket Set*	1	1	1
3	QAR67942	Seal Front	1	1	1
4	QR78598	Thrust Washer for Flange-less Bearing	4	4	4
5	QR57160	Balance Bush	6	6	6
6	QR57451	Rod Bush	4	4	4
7	QRE44574	Seal Rear	1	1	1
8	QAR81786	Thrust Bearing STD	1		
9	QAR97517	Rod Bearing STD	4		
10	QRE27352	Main Bearing STD	4		
11	QAR81788	Thrust Bearing 10 Thou		1	
12	QAR97653	Rod Bearing 10 Thou		4	
13	QRE27353	Main Bearing 10 Thou		4	
14	QAR81789	Thrust Bearing 20 Thou			1
15	QAR97654	Rod Bearing 20 Thou			4
16	QRE27360	Main Bearing 20 Thou			4



*Gasket Set

Head Set QRE501568 Contains		
R97354-B	Gasket, Inj Pump Mount	1.
R105346-B	Gasket, Turbo Oil Outlet	1.
R97348-B	Gasket, Turbo Oil Inlet	1.
R89879-B	Gasket, Turbo Mount	1.
R56463-B	O-Ring, Vent Tube Outlet	1.
R54641-B	Gasket, Thermostat to Cyl Head	1.
R54638-B	Gasket, Thermostat Cover, Dual	1.
R79551-B	Gasket, Oil Cooler Cover	1.
R77052-B	O-Ring	2.
R61871-B	O-Ring	1.
R56815-B	O-Ring, Oil Cooler to Cooler	1.
R56814-B	O-Ring, Oil Cooler to Housing	1.
R56193-B	O-Ring, Oil Cooler, Outer	1.
R56192-B	O-Ring, Oil Cooler, Inner	1.
U13639-B	O-Ring, Coolant Heater Plug	1.
R98834-B	Gasket, Oil Cooler to Cyl	1.
R98489-B	Gasket, Oil Cooler to Cyl	1.
R98488-B	Gasket, Oil Filter Adapter	1.
R98487-B	Gasket, Oil Cooler, Lower	1.
R98486-B	Gasket, Oil Cooler	2.
R98485-B	Gasket, Oil Cooler, Lower	1.
R98484-B	Gasket, Oil Cooler	1.

A4730R-B	O-Ring, Oil Pump Intake	1.
R48000	Seal, Pencil Injector	4.
R90658	Gasket, Exhaust Manifold	4.
R87627	O-Ring, Valve Stem	8.
R81275	Gasket, Air Inlet	1.
R60746	Seal, Pencil Injector	4.
T20219	Gasket, Thermostat Housing	1.
T20215	Gasket, Thermostat Cover	1.
R56461	O-Ring, Thermostat/Water Tube	1.
R97773	Gasket, Cover	1.
T20328	Gasket, Oil Filler Cap	1.
T20273	Gasket, Timing Gear Cover	1.
R97454	Gasket, Timing Gear Cover	1.
NT13213	Washer, Oil Drain Plug	1.
R97351	Gasket, Flywheel Housing	1.
R90648	Gasket, Block to End Plate	1.
R116025	Gasket, Water Pump Mount	1.
R70956	Packing, Oil Cooler	1.
R74354	O-Ring	1.
R75892	O-Ring, Oil Supply Tube	1.
R97350	Gasket, Fuel Transfer Pump	1.
R97352	Gasket, Oil Filler Inlet	1.
R73521-B	Gasket, Rocker Cover, 4 Cyl	1.

R97342-B	Gasket, Oil Pan, 4 Cyl,	1.
R79563-B	Sleeve, Rubber	1.
R77052-B	O-Ring	2.
R75892-B	O-Ring, Oil Supply Tube	1.
R74354-B	O-Ring	1.
R132256	Gasket, Oil Filler Housing	1.
R26286	O-Ring, Fuel Line	1.
R79563	Sleeve, Rubber	1.
R61871	O-Ring	1.
R56461	O-Ring, Thermostat/Water Tube	1.
T20304	O-Ring	1.
R125863-B	Gasket, Cyl Head, 4 Cyl,	1.

Rod Bolts

Part No.	Description	Qty.
QR74195	Rod Bolt 4045T 6068T 300 Series (64mm Long)	8



Gaskets

Gaskets			
	Part No.	Description	Qty.
1	QRE38851	Head Set	1
2	QRP341	Oil Pan Set	1

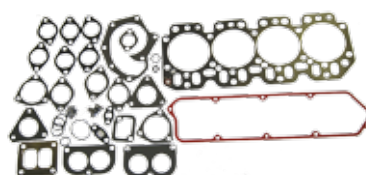

1



2

Valve Kit

Valve Kit 59236 Contains			
	Part No.	Description	Qty.
1	QR98062	Valve, Intake	4
2	QR90692	Valve, Exhaust	4
3	QR85687	Valve Seat, Exhaust	4
4	QR98063	Valve Seat, Intake	4
5	QRE60005	Rotator, Intake & Exhaust	8
6	QR26125	Spring, Valve, Intake & Exhaust	8
7	QR91889	Lock, Valve, Intake & Exhaust	16
8	QRE31617	Cap, Valve Stem	8



Ring Sets, Con Rod

	Part No.	Description
1	QRE66820	Ring Sets
2	QAR69710	Balancer Shaft Right
3	QAR69711	Balancer Shaft Left



Camshaft, Tappet

	Part No.	Description
1	QR82820	Camshaft
2	QT20073	Tappet (8)



6059D Engine Type

300 Series 5.9 Litres 6 Cylinders



RELIANCE

	Part No.	Description	10000 Standard Overhaul Kit	10010 .010" Kit	10020 .020" Kit	Bore
1	QRE30250	Cylinder Kit	6	6	6	106.5
1A	QAR65507	O Ring Kit	6	6	6	
2	QRE501580	Gasket Set*	1	1	1	
3	QAR67942	Seal Front	1	1	1	
4	QAR81786	Thrust Bearing Pair	1			
5	QAR81786	Thrust Bearing 10 Thou		1		
6	QAR81789	Thrust Bearing 20 Thou			1	
7	QR78598	Thrust Washer for Flangeless Bearing	4	4	4	
8	QR55647	Rod Bush	6	6	6	
9	QR80033	Rod Bolt LONG	12	12	12	
10	QRE44574	Seal Rear	1	1	1	
11	QRE27348	Rod Bearing STD	6			
12	QRE27349	Rod Bearing 10 Thou		6		
13	QRE27358	Rod Bearing 20 Thou			6	
14	QRE27352	Main Bearing STD	6			
15	QRE27353	Main Bearing 10 Thou		6		
16	QRE27360	Main Bearing 20 Thou			6	



*Gasket Set

Head Set QRE501580 Contains		
R114157-B	Gasket, Cyl Head, 6 Cyl,	1
T24932	Gasket, Thermostat Cover	1
NT23002	Gasket, Water Manifold Outlet	3
R60746	Seal, Pencil Injector	6
R56905	O-Ring, Air Intake	1
R81275	Gasket, Air Inlet	2
R87627	O-Ring, Valve Stem	12
R90658	Gasket, Exhaust Manifold	6
NR48000	Seal, Pencil Injector	6
R97354-B	Gasket, Inj Pump Mount	1
R105346-B	Gasket, Turbo Oil Outlet	1
R97348-B	Gasket, Turbo Oil Inlet	1
R89879-B	Gasket, Turbo Mount	1
R56463-B	O-Ring, Vent Tube Outlet	1
R54641-B	Gasket, Thermostat to Cyl Head	1
R54638-B	Gasket, Thermostat Cover, Dual	1
R56461	O-Ring, Thermostat/Water Tube	1
R97773	Gasket, Cover	1
T20328	Gasket, Oil Filler Cap	1
T20273	Gasket, Timing Gear Cover	1
R97454	Gasket, Timing Gear Cover	1
T13213	Washer, Oil Drain Plug	1
R97351	Gasket, Flywheel Housing	1

R90648	Gasket, Block to End Plate	1
R116025	Gasket, Water Pump Mount	1
R70956	Packing, Oil Cooler	1
R74354	O-Ring	1
R75892	O-Ring, Oil Supply Tube	1
R97350	Gasket, Fuel Transfer Pump	1
R97352	Gasket, Oil Filler Inlet	1
R75728-B	Gasket, Rocker Cover, 6 Cyl	1
R79551-B	Gasket, Oil Cooler Cover	1
R77052-B	O-Ring	2
R61871-B	O-Ring	1
R56815-B	O-Ring, Oil Cooler to Cooler	1
R56814-B	O-Ring, Oil Cooler to Housing	1
R56193-B	O-Ring, Oil Cooler, Outer	1
R56192-B	O-Ring, Oil Cooler, Inner	1
U13639-B	O-Ring, Coolant Heater Plug	1
R98834-B	Gasket, Oil Cooler to Cyl	1
R98489-B	Gasket, Oil Cooler to Cyl	1
R98488-B	Gasket, Oil Filter Adapter	1
R98487-B	Gasket, Oil Cooler, Lower	1
R98486-B	Gasket, Oil Cooler	2
R98485-B	Gasket, Oil Cooler, Lower	1
R98484-B	Gasket, Oil Cooler	1

NR90648	Gasket, Block to End Plate	1
A4730R-B	O-Ring, Oil Pump Intake	1
R26286-B	O-Ring, Fuel Line	1
R97354-B	Gasket, Inj Pump Mount	1
R61871-B	O-Ring	1
R56461-B	O-Ring, Thermostat/Water Tube	1
T23132-B	Gasket, Water Inlet	1
R116025-B	Gasket, Water Pump Mount	1
T20304-B	O-Ring	1
R98488	Gasket, Oil Filter Adapter	1
R77052	O-Ring	2
R74354	O-Ring	1
R61871	O-Ring	2
R97344	Subs to RP343	1

jd18

Original equipment manufacturer names and part numbers are quoted for reference purposes only and are not intended to infer that our replacement parts are used as original equipment.

Pg Modified By:
AD

Date Modified:
30-4-14

Approved By:
AB

Ver 4.1

MOD 05-05-15

6059T Engine Type

300 Series 5.9 Litres 6 Cylinders



RELIANCE

	Part No.	Description	10030 Standard Overhaul Kit	10040 .010" Kit	10050 .020" Kit	Bore
1	QRE33115	Cylinder Kit	6	6	6	106.5
1A	QAR65507	O Ring Kit	6	6	6	
2	QRE501580	Gasket Set*	1	1	1	
3	QAR67942	Seal Front	1	1	1	
4	QAR81786	Thrust Bearing Pair	1			
5	QAR81788	Thrust Bearing 10 Thou		1		
6	QAR81789	Thrust Bearing 20 Thou			1	
7	QR78598	Thrust Washer for Flangeless Bearing	4	4	4	
8	QR57451	Rod Bush	6	6	6	
9	QR80033	Rod Bolt LONG	12	12	12	
10	QRE44574	Seal Rear	1	1	1	
11	QRE27348	Rod Bearing STD	6			
12	QRE27349	Rod Bearing 10 Thou		6		
13	QRE27358	Rod Bearing 20 Thou			6	
14	QRE27352	Main Bearing STD	6			
15	QRE27353	Main Bearing 10 Thou		6		
16	QRE27360	Main Bearing 20 Thou			6	



*Gasket Set

Head Set QRE501580 Contains		
R114157-B	Gasket, Cyl Head, 6 Cyl,	1
T24932	Gasket, Thermostat Cover	1
T23002	Gasket, Water Manifold Outlet	3
R60746	Seal, Pencil Injector	6
R56905	O-Ring, Air Intake	1
R81275	Gasket, Air Inlet	2
R87627	O-Ring, Valve Stem	12
R90658	Gasket, Exhaust Manifold	6
R48000	Seal, Pencil Injector	6
R97354-B	Gasket, Inj Pump Mount	1
R105346-B	Gasket, Turbo Oil Outlet	1
R97348-B	Gasket, Turbo Oil Inlet	1
R89879-B	Gasket, Turbo Mount	1
R56463-B	O-Ring, Vent Tube Outlet	1
R54641-B	Gasket, Thermostat to Cyl Head	1
R54638-B	Gasket, Thermostat Cover, Dual	1
R56461	O-Ring, Thermostat/Water Tube	1
R97773	Gasket, Cover	1
T20328	Gasket, Oil Filler Cap	1
T20273	Gasket, Timing Gear Cover	1
R97454	Gasket, Timing Gear Cover	1

T13213	Washer, Oil Drain Plug	1
R97351	Gasket, Flywheel Housing	1
R90648	Gasket, Block to End Plate	1
R116025	Gasket, Water Pump Mount	1
R70956	Packing, Oil Cooler	1
R74354	O-Ring	1
R75892	O-Ring, Oil Supply Tube	1
R97350	Gasket, Fuel Transfer Pump	1
R97352	Gasket, Oil Filler Inlet	1
R75728-B	Gasket, Rocker Cover, 6 Cyl	1
R79551-B	Gasket, Oil Cooler Cover	1
R77052-B	O-Ring	2
R61871-B	O-Ring	1
R56815-B	O-Ring, Oil Cooler to Cooler	1
R56814-B	O-Ring, Oil Cooler to Housing	1
R56193-B	O-Ring, Oil Cooler, Outer	1
R56192-B	O-Ring, Oil Cooler, Inner	1
U13639-B	O-Ring, Coolant Heater Plug	1
R98834-B	Gasket, Oil Cooler to Cyl	1
R98489-B	Gasket, Oil Cooler to Cyl	1
R98488-B	Gasket, Oil Filter Adapter	1

R98487-B	Gasket, Oil Cooler, Lower	1
R98486-B	Gasket, Oil Cooler	2
R98485-B	Gasket, Oil Cooler, Lower	1
R98484-B	Gasket, Oil Cooler	1
R90648	Gasket, Block to End Plate	1
A4730R-B	O-Ring, Oil Pump Intake	1
R26286-B	O-Ring, Fuel Line	1
NR97354-B	Gasket, Inj Pump Mount	1
R61871-B	O-Ring	1
R56461-B	O-Ring, Thermostat/Water Tube	1
T23132-B	Gasket, Water Inlet	1
R116025-B	Gasket, Water Pump Mount	1
T20304-B	O-Ring	1
R98488	Gasket, Oil Filter Adapter	1
R77052	O-Ring	2
R74354	O-Ring	1
R61871	O-Ring	2
R97344	Subs to RP343	1

6068T Turbo Engine

300 Series 6.8 Litres 6 Cylinders

Engine Overhaul Kits

Part No.	Description	95000 Standard Overhaul Kit	95010 .010" Kit	95020 .020" Kit
1	QRE53073	Cylinder Kit Bore 106.5	6	6
1A	QAR65507	O Ring Kit	6	6
2	QRE501569	Gasket Set*	1	1
3	QAR67942	Seal Front	1	1
4	QR78598	Thrust Washer for Flange-less Bearing	4	4
5	QR57451	Rod Bush	6	6
6	QRE44574	Seal Rear	1	1
7	QAR81786	Thrust Bearing STD	1	
8	QAR97517	Rod Bearing STD	6	
9	QRE27352	Main Bearing STD	6	
10	QAR81788	Thrust Bearing 10 Thou		1
11	QAR97653	Rod Bearing 10 Thou		6
12	QRE27353	Main Bearing 10 Thou		6
13	QAR81789	Thrust Bearing 20 Thou		1
14	QAR97654	Rod Bearing 20 Thou		6
15	QRE27360	Main Bearing 20 Thou		6

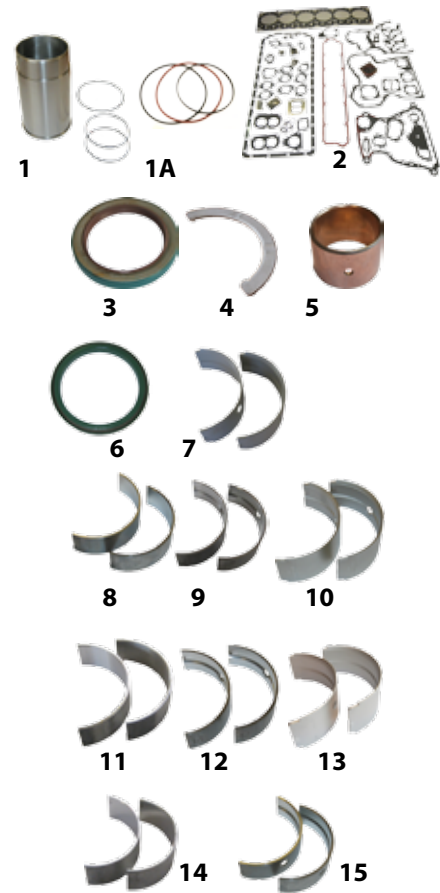

*Gasket Set

Head Set QRE501569 Contains		
R114157-B	Gasket, Cyl Head, 6 Cyl,	1.
T24932	Gasket, Thermostat Cover	1.
T23002	Gasket, Water Manifold Outlet	3.
R60746	Seal, Pencil Injector	6.
R56905	O-Ring, Air Intake	1.
R81275	Gasket, Air Inlet	2.
R87627	O-Ring, Valve Stem	12.
R90658	Gasket, Exhaust Manifold	6.
R48000	Seal, Pencil Injector	6.
R97354-B	Gasket, Inj Pump Mount	1.
R105346-B	Gasket, Turbo Oil Outlet	1.
R97348-B	Gasket, Turbo Oil Inlet	1.
R89879-B	Gasket, Turbo Mount	1.
R56463-B	O-Ring, Vent Tube Outlet	1.
R54641-B	Gasket, Thermostat to Cyl Head	1.
R54638-B	Gasket, Thermostat Cover, Dual	1.
R79551-B	Gasket, Oil Cooler Cover	1.
R77052-B	O-Ring	2.
R61871-B	O-Ring	1.
R56815-B	O-Ring, Oil Cooler to Cooler	1.
R56814-B	O-Ring, Oil Cooler to Housing	1.
R56193-B	O-Ring, Oil Cooler, Outer	1.
R56192-B	O-Ring, Oil Cooler, Inner	1.
U13639-B	O-Ring, Coolant Heater Plug	1.
R98834-B	Gasket, Oil Cooler to Cyl	1.

R98489-B	Gasket, Oil Cooler to Cyl	1.
R98488-B	Gasket, Oil Filter Adapter	1.
R98487-B	Gasket, Oil Cooler, Lower	1.
R98486-B	Gasket, Oil Cooler	2.
R98485-B	Gasket, Oil Cooler, Lower	1.
R98484-B	Gasket, Oil Cooler	1.
A4730R-B	O-Ring, Oil Pump Intake	1.
R56461	O-Ring, Thermostat/Water Tube	1.
R97773	Gasket, Cover	1.
T20328	Gasket, Oil Filler Cap	1.
T20273	Gasket, Timing Gear Cover	1.
R97454	Gasket, Timing Gear Cover	1.
T13213	Washer, Oil Drain Plug	1.
T13213-B	Washer, Oil Drain Plug	1.
R97351	Gasket, Flywheel Housing	1.
R90648	Gasket, Block to End Plate	1.
R116025	Gasket, Water Pump Mount	1.
R70956	Packing, Oil Cooler	1.
R74354	O-Ring	1.
R75892	O-Ring, Oil Supply Tube	1.
R97350	Gasket, Fuel Transfer Pump	1.
R97352	Gasket, Oil Filler Inlet	1.
R75728-B	Gasket, Rocker Cover, 6 Cyl	1.
R98488	Gasket, Oil Filter Adapter	1.
R77052	O-Ring	2.
R74354	O-Ring	1.

R61871	O-Ring	2.
R97344	Subs to RP343	1.
R97346	Gasket, Water Line	1.
R52811	O-Ring, Inlet, Outlet	2.
T23132	Gasket, Water Inlet	1.
R132256	Gasket, Oil Filler Housing	1.
R26286	O-Ring, Fuel Line	1.
R79563	Sleeve, Rubber	1.
R61871	O-Ring	1.
R56461	O-Ring, Thermostat/Water Tube	1.
T20304	O-Ring	1.

Rod Bolts

Part No.	Description	Qty.
QR74195	Rod Bolt 4045T 6068T 300 Series (64mm Long)	12



Gaskets

Gaskets			
	Part No.	Description	Qty.
1	QRE38852	Head Set	1
2	QRP343	Oil Pan Set	1
3	QRP682	Conversion Set	1

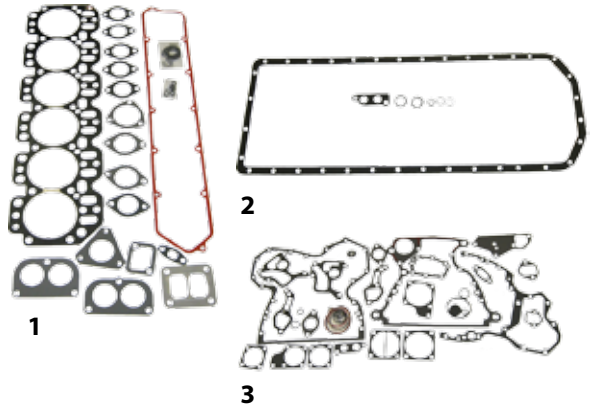

Valve Kit

Valve Kit 59235 Contains			
	Part No.	Description	Qty.
1	QR98062	Valve, Intake	6
2	QR90692	Valve, Exhaust	6
3	QR85687	Valve Seat, Exhaust	6
4	QR98063	Valve Seat, Intake	6
5	QRE60005	Rotator, Intake & Exhaust	12
6	QR26125	Spring, Valve, Intake & Exhaust	12
7	QR91889	Lock, Valve, Intake & Exhaust	24
8	QRE31617	Cap, Valve Stem	12



Ring Sets

Part No.	Description
1	QRE66820



Camshaft, Tappet

Part No.	Description
1	QR82821
2	QT20073



4045D 4.5 Powertech®

350 Series 4.5 Litres 4 Cylinders

	Part No.	Description	96000 Standard Overhaul Kit	96010 .010" Kit
1	QRE505110	Cylinder Kit* Bore106.5	4	4
1A	QAR65507	O Ring Kit	4	4
2	QRE501455	Gasket Set*	1	1
3	QR115299	Balance Bush	6	6
4	QR119874	Cam Bush	1	1
5	QR123960	Rod Bush	4	4
6	QRE65168	Thrust Bearing STD	1	
7	QRE65908	Rod Bearing STD	4	
8	QRE65165	Main Bearing STD	4	
9	QRE65912	Thrust Bearing 10 Thou		1
10	QRE65909	Rod Bearing 10 Thou		4
11	QRE65911	Main Bearing 10 Thou		4



*Gasket Set

Gasket Set QRE501455 Contains		
R116515-B	Gasket, Cyl Head, 4.5 PT	1
RE516340	Seal, Crankshaft, Front	1
RE44574	SEAL,CRANKSHAFT,REAR	1
R92097-B	Gasket, Turbo Mount	1
R123226-B	Seal, Water Bypass Tube	2
R90658-B	Gasket, Exhaust Manifold	4
R123570-B	Gasket, Turbo Oil Drain	1
R54638-B	Gasket, Thermostat Cover, Dual	1
R123345-B	Gasket, Tstat Housing	1
R121416-B	Gasket, Water Pump To Head	1
R81275-B	Gasket, Air Inlet	2
R123575-B	O-Ring	4
R503891-B	Gasket, Turbo Oil Drain	1
R136516-B	Gasket, Timing Cover	1
R136515-B	Gasket, Timing Cover	1
R520131-B	Gasket, Timing Cover	1

R520132-B	Gasket, Timing Cover	1
A4827R-B	Washer, Special Aluminum	1
R123501-B	Gasket, Oil Cooler Housing	1
R502864-B	Gasket, Remote OF Adapter	1
R53108-B	Gasket, Starter to Block	1
R72328-B	O-Ring, Turbo Return/Water	4
R123273-B	O-Ring, Fuel Pump	1
R89944-B	O-Ring, Injector Pump Mount	1
R61105-B	O-Ring, Tube to Timing Cover	2
T122075-B	O-Ring	2
R500374-B	Gasket, Oil Filter Header	1
R123525-B	Gasket, Oil Filter Header	1
R501428-B	Gasket, Coolant Passage	1
R123417-B	Gasket, Water Pump	1
R502902-B	Packing, Oil Fill Cap	1
R136495-B	Gasket, Oil Fill Cover	3

Rod Bolts

Part No.	Description	Qty.	Note
QR114083	Rod Bolt	8	For Con Rods Marked: R123959 (64mm Long)
QR501124	Rod Bolt Long	8	For Con Rods Marked: R500000 (61mm Long)

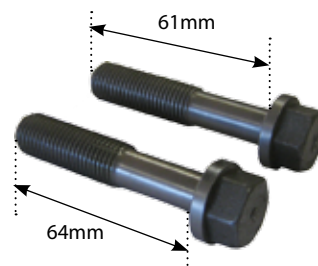

Gaskets

Gaskets			
	Part No.	Description	Qty.
1	QRE66082	Head Set	1
2	QRP793	Sump Set	1

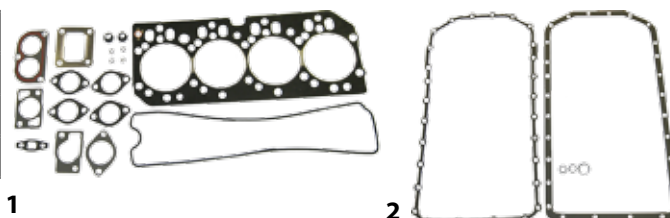

Valve Kit

Valve Kit 59240 Contains			
	Part No.	Description	Qty.
1	QR98062	Valve, Intake	4
2	QR90692	Valve, Exhaust	4
3	QR85687	Valve Seat, Exhaust	4
4	QR98063	Valve Seat, Intake	4
5	QRE60005	Rotator, Intake & Exhaust	8
6	QR26125	Spring, Valve, Intake & Exhaust	8
7	QR91889	Lock, Valve, Intake & Exhaust	16
8	QRE31617	Cap, Valve Stem	8



For Tractors with 4 Valve Cylinders

	Part No.	Description	Qty.
1	QR502370	Valve, Exhaust	8
2	QR502369	Valve, Inlet	8

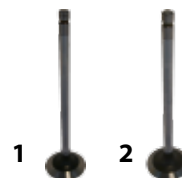

Ring Sets & Balancer Shafts

	Part No.	Description
1	QRE66271	Ring Sets
2	QRE500448	Balancer Shaft Right
3	QRE500449	Balancer Shaft Left

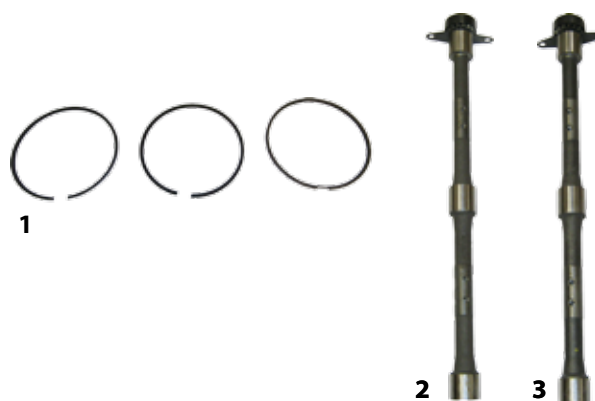

	Part No.	Description	98000 Standard Overhaul Kit	98010 .010" Kit
1	QRE507920	Cylinder Kit* Bore 106.5	4	4
1A	QAR65507	O Ring Kit Liner Seals	1	1
2	QRE501455	Gasket Set	1	1
3	QR115299	Balance Bush	6	6
4	QR119874	Cam Bush	1	1
5	QR123960	Rod Bush	4	4
6	QRE65168	Thrust Bearing STD	1	
7	QRE65908	Rod Bearing STD	4	
8	QRE65165	Main Bearing STD	4	
9	QRE65912	Thrust Bearing 10 Thou		1
10	QRE65909	Rod Bearing 10 Thou		4
11	QRE65911	Main Bearing 10 Thou		4



*Gasket Set

Gasket Set QRE501455 Contains		
R116515-B	Gasket, Cyl Head, 4.5 PT	1
RE516340	Seal, Crankshaft, Front	1
RE44574	SEAL,CRANKSHAFT,REAR	1
R92097-B	Gasket, Turbo Mount	1
R123226-B	Seal, Water Bypass Tube	2
R90658-B	Gasket, Exhaust Manifold	4
R123570-B	Gasket, Turbo Oil Drain	1
R54638-B	Gasket, Thermostat Cover, Dual	1
R123345-B	Gasket, Tstat Housing	1
R121416-B	Gasket, Water Pump To Head	1
R81275-B	Gasket, Air Inlet	2
R123575-B	O-Ring	4
R503891-B	Gasket, Turbo Oil Drain	1
R136516-B	Gasket, Timing Cover	1
R136515-B	Gasket, Timing Cover	1
R520131-B	Gasket, Timing Cover	1

R520132-B	Gasket, Timing Cover	1
A4827R-B	Washer, Special Aluminum	1
R123501-B	Gasket, Oil Cooler Housing	1
R502864-B	Gasket, Remote OF Adapter	1
R53108-B	Gasket, Starter to Block	1
R72328-B	O-Ring, Turbo Return/Water	4
R123273-B	O-Ring, Fuel Pump	1
R89944-B	O-Ring, Injector Pump Mount	1
R61105-B	O-Ring, Tube to Timing Cover	2
T122075-B	O-Ring	2
R500374-B	Gasket, Oil Filter Header	1
R123525-B	Gasket, Oil Filter Header	1
R501428-B	Gasket, Coolant Passage	1
R123417-B	Gasket, Water Pump	1
R502902-B	Packing, Oil Fill Cap	1
R136495-B	Gasket, Oil Fill Cover	3

Rod Bolts

Part No.	Description	Qty.	Note
QR114083	Rod Bolt	8	For Con Rods Marked: R123959 (64mm Long)
QR501124	Rod Bolt Long	8	For Con Rods Marked: R500000 (61mm Long)

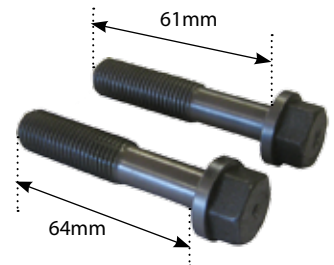

Gaskets

	Part No.	Description	Qty.
1	QRE66082	Head Set	1
2	QRP793	Sump Gasket Set	1

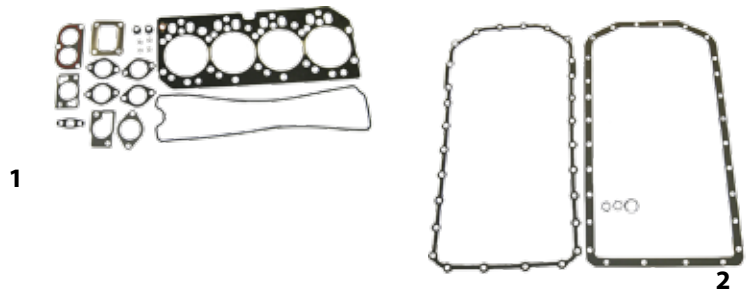

Valve Kit

Valve Kit 59235 Contains			
	Part No.	Description	Qty.
1	QR98062	Valve, Intake	4
2	QR90692	Valve, Exhaust	4
3	QR85687	Valve Seat, Exhaust	4
4	QR98063	Valve Seat, Intake	4
5	QRE60005	Rotator, Intake & Exhaust	8
6	QR26125	Spring, Valve, Intake & Exhaust	8
7	QR91889	Lock, Valve, Intake & Exhaust	16
8	QRE31617	Cap, Valve Stem	8



Ring Sets

	Part No.	Description
1	QRE507852	Ring Sets
2	QRE500448	Balancer Shaft Right
3	QRE500449	Balancer Shaft Left

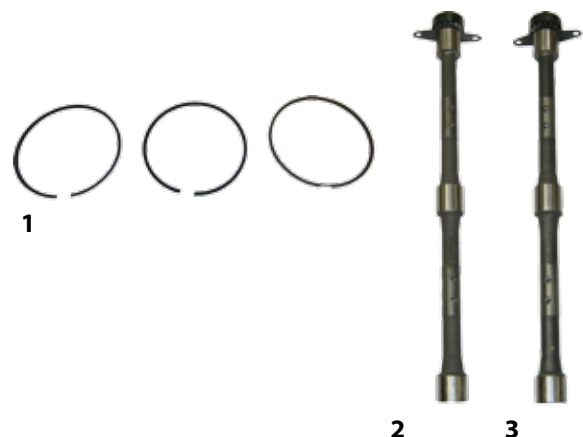

6068D 6.8D Powertech®

350 Series 6.8 Litres 6 Cylinders

	Part No.	Description	97000 Standard Overhaul Kit	97010 .010" Kit
1	QRE505110	Cylinder Kit Bore 106.5	6	6
1A	QAR65507	O Ring Kit	6	6
2	QRE501456	Gasket Set	1	1
3	QR119874	Cam Bush	1	1
4	QR123960	Rod Bush	6	6
5	QRE65168	Thrust Bearing STD	1	
6	QRE65908	Rod Bearing STD	6	
7	QRE65165	Main Bearing STD	6	
8	QRE65912	Thrust Bearing 10 Thou		1
9	QRE65909	Rod Bearing 10 Thou		6
10	QRE65911	Main Bearing 10 Thou		6

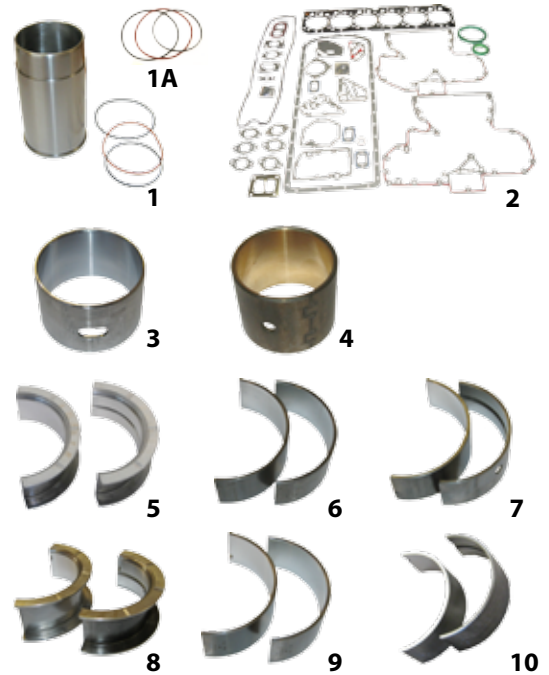

*Gasket Set

Gasket Set QRE501456 Contains			
RE516340	Seal, Crankshaft, Front	1	
RE516340-B	Seal, Crankshaft, Front	1	
RE44574	Seal, Crankshaft, Rear	1	
R116516-B	Gasket, Cyl Head, 6.8 PT	1	
R123572-B	Gasket, Turbo Mount	1	
R123226-B	Seal, Water Bypass Tube	2	
R90658-B	Gasket, Exhaust Manifold	6	
R123570-B	Gasket, Turbo Oil Drain	1	
R54638-B	Gasket, Thermostat Cover, Dual	1	
R123345-B	Gasket, Tstat Housing	1	
R121416-B	Gasket, Water Pump To Head	1	
R81275-B	Gasket, Air Inlet	2	
R123575-B	O-Ring	6	
R136516-B	Gasket, Timing Cover	1	
R136515-B	Gasket, Timing Cover	1	
R520131-B	Gasket, Timing Cover	1	

R520131-B	Gasket, Timing Cover	1	
R520132-B	Gasket, Timing Cover	1	
A4827R-B	Washer, Special Aluminum	1	
R123501-B	Gasket, Oil Cooler Housing	1	
R502864-B	Gasket, Remote OF Adapter	1	
R53108	Gasket, Starter to Block	1	
R72328-B	O-Ring, Turbo Return/Water	4	
R123273-B	O-Ring, Fuel Pump	1	
R89944	O-Ring, Injector Pump Mount	1	
R61105-B	O-Ring, Tube to Timing Cover	2	
T122075-B	O-Ring	2	
R500374-B	Gasket, Oil Filter Header	1	
R123525-B	Gasket, Oil Filter Header	1	
R501428-B	Gasket, Coolant Passage	1	
R123417-B	Gasket, Water Pump	1	
R502902-B	Packing, Oil Fill Cap	1	
R136495-B	Gasket, Oil Fill Cover	3	

Cylinder Kit Tier II

QRE516227

Cylinder Kit Tier II John Deere 6320 6420



Rod Bolts

Part No.	Description	Qty.	Note
QR114083	Rod Bolt	12	For Con Rods Marked: R123959 (64mm Long)
QR501124	Rod Bolt Long	12	For Con Rods Marked: R500000 (61mm Long)

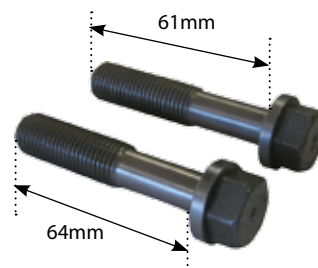

Gaskets

	Part No.	Description	Qty.
1	QRE66083	Head Set	1
2	QRP794	Sump Gasket Set	1

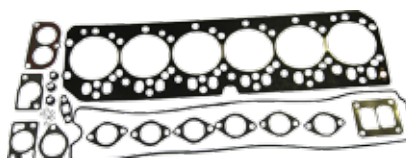

1

2

Valve Kit

Valve Kit 59235 Contains			
	Part No.	Description	Qty.
1	QR98062	Valve, Intake	6
2	QR90692	Valve, Exhaust	6
3	QR85687	Valve Seat, Exhaust	6
4	QR98063	Valve Seat, Intake	6
5	QRE60005	Rotator, Intake & Exhaust	12
6	QR26125	Spring, Valve, Intake & Exhaust	12
7	QR91889	Lock, Valve, Intake & Exhaust	24
8	QRE31617	Cap, Valve Stem	12



For Tractors with 4 Valve Cylinders

	Part No.	Description	Qty.
1	QR502370	Valve, Exhaust	12
2	QR502369	Valve, Inlet	12

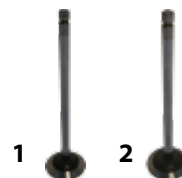

Ring Sets

	Part No.	Description
1	QRE66271	Ring Sets



1

6068T 6.8T Powertech®

350 Series 6.8 Litres 6 Cylinders

	Part No.	Description	99000 Standard Overhaul Kit	99010 .010" Kit
1	QRE507920		6	6
1A	QAR65507	O Ring Kit	6	6
2	QRE501456	Gasket Set*	1	1
3	QR119874	Cam Bush	1	1
4	QR123960	Rod Bush	6	6
5	QRE65168	Thrust Bearing STD	1	
6	QRE65908	Rod Bearing STD	6	
7	QRE65165	Main Bearing STD	6	
8	QRE65912	Thrust Bearing 10 Thou		1
9	QRE65909	Rod Bearing 10 Thou		6
10	QRE65911	Main Bearing 10 Thou		6



*Gasket Set

Gasket Set QRE501456 Contains			
RE516340	Seal, Crankshaft, Front	1	
RE516340-B	Seal, Crankshaft, Front	1	
RE44574	Seal, Crankshaft, Rear	1	
R116516-B	Gasket, Cyl Head, 6.8 PT	1	
R123572-B	Gasket, Turbo Mount	1	
R123226-B	Seal, Water Bypass Tube	2	
R90658-B	Gasket, Exhaust Manifold	6	
R123570-B	Gasket, Turbo Oil Drain	1	
R54638-B	Gasket, Thermostat Cover, Dual	1	
R123345-B	Gasket, Tstat Housing	1	
R121416-B	Gasket, Water Pump To Head	1	
R81275-B	Gasket, Air Inlet	2	
R123575-B	O-Ring	6	
R136516-B	Gasket, Timing Cover	1	
R136515-B	Gasket, Timing Cover	1	
R520131-B	Gasket, Timing Cover	1	

R520131-B	Gasket, Timing Cover	1	
R520132-B	Gasket, Timing Cover	1	
A4827R-B	Washer, Special Aluminum	1	
R123501-B	Gasket, Oil Cooler Housing	1	
R502864-B	Gasket, Remote OF Adapter	1	
R53108	Gasket, Starter to Block	1	
R72328-B	O-Ring, Turbo Return/Water	4	
R123273-B	O-Ring, Fuel Pump	1	
R89944	O-Ring, Injector Pump Mount	1	
R61105-B	O-Ring, Tube to Timing Cover	2	
T122075-B	O-Ring	2	
R500374-B	Gasket, Oil Filter Header	1	
R123525-B	Gasket, Oil Filter Header	1	
R501428-B	Gasket, Coolant Passage	1	
R123417-B	Gasket, Water Pump	1	
R502902-B	Packing, Oil Fill Cap	1	
R136495-B	Gasket, Oil Fill Cover	3	

Rod Bolts

Part No.	Description	Qty.	Note
QR114083	Rod Bolt	12	For Con Rods Marked: R123959 (64mm Long)
QR501124	Rod Bolt Long	12	For Con Rods Marked: R500000 (61mm Long)

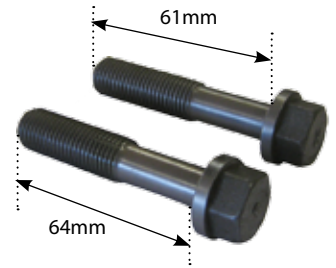

Gaskets

	Part No.	Description	Qty.
1	QRE66083	Head Set	1
2	QRP794	Sump Gasket Set	1

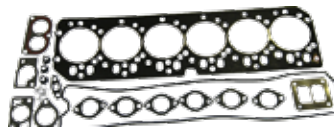

1



2

Valve Kit

Valve Kit 59235 Contains			
	Part No.	Description	Qty.
1	QR98062	Valve, Intake	6
2	QR90692	Valve, Exhaust	6
3	QR85687	Valve Seat, Exhaust	6
4	QR98063	Valve Seat, Intake	6
5	QRE60005	Rotator, Intake & Exhaust	12
6	QR26125	Spring, Valve, Intake & Exhaust	12
7	QR91889	Lock, Valve, Intake & Exhaust	24
8	QRE31617	Cap, Valve Stem	12



Ring Sets

	Part No.	Description
1	QRE507852	Ring Sets



1

4045T Turbo High Horsepower 4.5T Powertech®

350 Series 4.5 Litres 4 Cylinders

	Part No.	Description	99500 Standard Overhaul Kit	99510 .010" Kit
1	QRE507850	Cylinder Kit 106.5 Bore	4	4
1A	QAR65507	O Ring Kit	4	4
2	QRE501455	Gasket Set*	1	1
3	QR115299	Balance Bush	6	6
4	QR119874	Cam Bush	1	1
5	QR114082	Rod Bush	4	4
6	QRE65168	Thrust Bearing STD	1	
7	QRE65908	Rod Bearing STD	4	
8	QRE65165	Main Bearing STD	4	
9	QRE65912	Thrust Bearing 10 Thou		1
10	QRE65909	Rod Bearing 10 Thou		4
11	QRE65911	Main Bearing 10 Thou		4

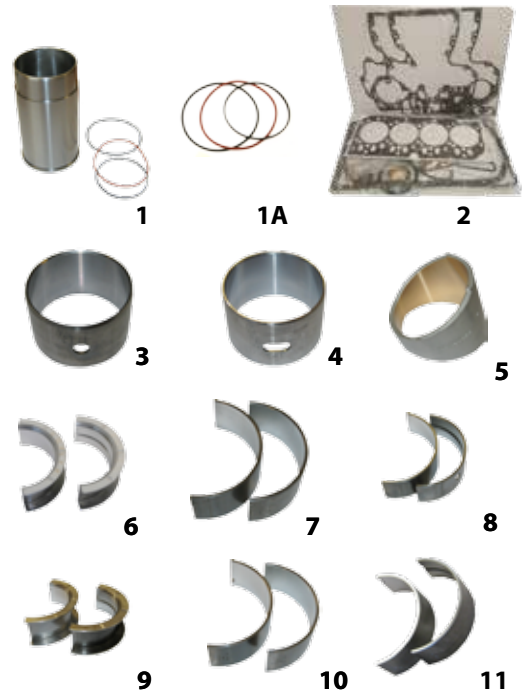

*Gasket Set

Gasket Set QRE501455 Contains		
R116515-B	Gasket, Cyl Head, 4.5 PT	1
RE516340	Seal, Crankshaft, Front	1
RE44574	SEAL,CRANKSHAFT,REAR	1
R92097-B	Gasket, Turbo Mount	1
R123226-B	Seal, Water Bypass Tube	2
R90658-B	Gasket, Exhaust Manifold	4
R123570-B	Gasket, Turbo Oil Drain	1
R54638-B	Gasket, Thermostat Cover, Dual	1
R123345-B	Gasket, Tstat Housing	1
R121416-B	Gasket, Water Pump To Head	1
R81275-B	Gasket, Air Inlet	2
R123575-B	O-Ring	4
R503891-B	Gasket, Turbo Oil Drain	1
R136516-B	Gasket, Timing Cover	1
R136515-B	Gasket, Timing Cover	1
R520131-B	Gasket, Timing Cover	1

R520132-B	Gasket, Timing Cover	1
A4827R-B	Washer, Special Aluminum	1
R123501-B	Gasket, Oil Cooler Housing	1
R502864-B	Gasket, Remote OF Adapter	1
R53108-B	Gasket, Starter to Block	1
R72328-B	O-Ring, Turbo Return/Water	4
R123273-B	O-Ring, Fuel Pump	1
R89944-B	O-Ring, Injector Pump Mount	1
R61105-B	O-Ring, Tube to Timing Cover	2
T122075-B	O-Ring	2
R500374-B	Gasket, Oil Filter Header	1
R123525-B	Gasket, Oil Filter Header	1
R501428-B	Gasket, Coolant Passage	1
R123417-B	Gasket, Water Pump	1
R502902-B	Packing, Oil Fill Cap	1
R136495-B	Gasket, Oil Fill Cover	3

Cylinder Kit Tier II

QRE516227

Cylinder Kit Tier II John Deere 6320 6420



Rod Bolts

Part No.	Description	Qty.	Note
QR114083	Rod Bolt	8	For Con Rods Marked: R123959 (64mm Long)
QR501124	Rod Bolt Long	8	For Con Rods Marked: R500000 (61mm Long)

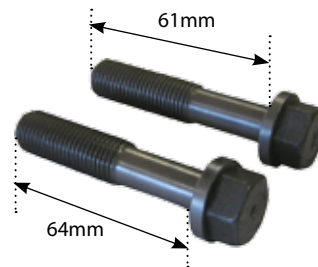

Gaskets

	Part No.	Description	Qty.
1	QRE66082	Head Set	1
2	QRP793	Sump Gasket Set	1

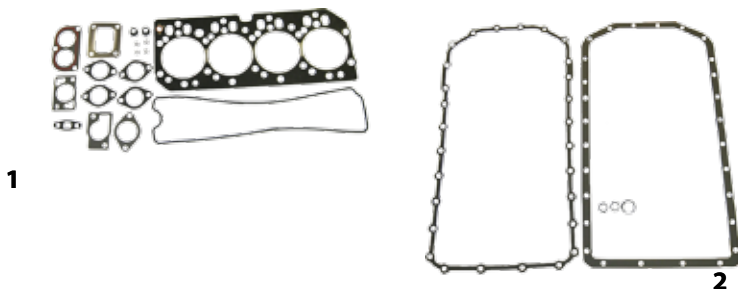

Valve Kit

Valve Kit 59240 Contains			
	Part No.	Description	Qty.
1	QR98062	Valve, Intake	4
2	QR90692	Valve, Exhaust	4
3	QR85687	Valve Seat, Exhaust	4
4	QR98063	Valve Seat, Intake	4
5	QRE60005	Rotator, Intake & Exhaust	8
6	QR26125	Spring, Valve, Intake & Exhaust	8
7	QR91889	Lock, Valve, Intake & Exhaust	16
8	QRE31617	Cap, Valve Stem	8



For Tractors with 4 Valve Cylinders

	Part No.	Description	Qty.
1	QR502370	Valve, Exhaust	8
2	QR502369	Valve, Inlet	8

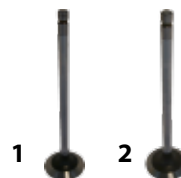

Ring Sets

	Part No.	Description
1	QRE507852	Ring Sets
2	QRE500448	Balancer Shaft Right
3	QRE500449	Balancer Shaft Left

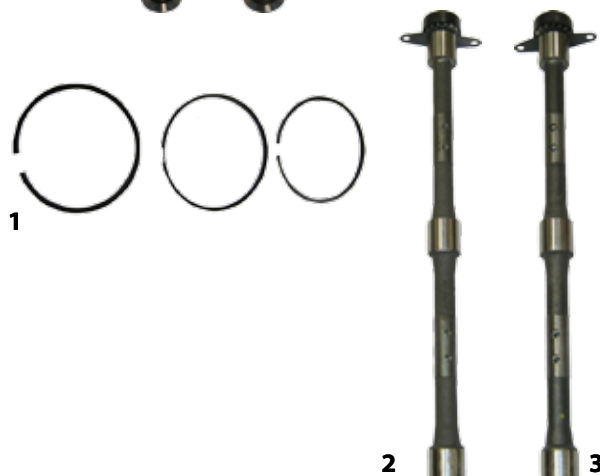

6068H Turbo High Horsepower 6.8T High Horse Powertech®

350 Series 6.8 Litres 6 Cylinders

	Part No.	Description	Standard Overhaul Kit 99600	.010" Kit 99610
1	QRE507850	Cylinder Kit Bore 106.5	6	6
1A	QAR65507	O Ring Kit	6	6
2	QRE501456	Gasket Set*	1	1
3	QR119874	Cam Bush	1	1
4	QR114082	Rod Bush	6	6
5	QRE65168	Thrust Bearing STD	1	
6	QRE65908	Rod Bearing STD	6	
7	QRE65165	Main Bearing STD	6	
8	QRE65912	Thrust Bearing 10 Thou		1
9	QRE65909	Rod Bearing 10 Thou		6
10	QRE65911	Main Bearing 10 Thou		6

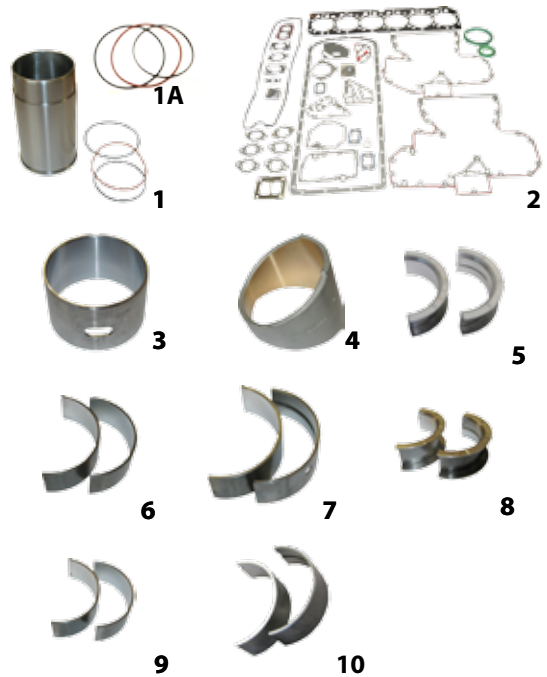

*Gasket Set

Gasket Set QRE501456 Contains		
NRE516340	Seal, Crankshaft, Front	1
NRE516340-B	Seal, Crankshaft, Front	1
NRE44574	Seal, Crankshaft, Rear	1
NR116516-B	Gasket, Cyl Head, 6.8 PT	1
NR123572-B	Gasket, Turbo Mount	1
NR123226-B	Seal, Water Bypass Tube	2
NR90658-B	Gasket, Exhaust Manifold	6
NR123570-B	Gasket, Turbo Oil Drain	1
NR54638-B	Gasket, Thermostat Cover, Dual	1
NR123345-B	Gasket, Tstat Housing	1
NR121416-B	Gasket, Water Pump To Head	1
NR81275-B	Gasket, Air Inlet	2
NR123575-B	O-Ring	6
NR136516-B	Gasket, Timing Cover	1
NR136515-B	Gasket, Timing Cover	1
NR520131-B	Gasket, Timing Cover	1

NR520132-B	Gasket, Timing Cover	1
NA4827R-B	Washer, Special Aluminum	1
NR123501-B	Gasket, Oil Cooler Housing	1
NR502864-B	Gasket, Remote OF Adapter	1
NR53108	Gasket, Starter to Block	1
NR72328-B	O-Ring, Turbo Return/Water	4
NR123273-B	O-Ring, Fuel Pump	1
NR89944	O-Ring, Injector Pump Mount	1
NR61105-B	O-Ring, Tube to Timing Cover	2
NT122075-B	O-Ring	2
NR500374-B	Gasket, Oil Filter Header	1
NR123525-B	Gasket, Oil Filter Header	1
NR501428-B	Gasket, Coolant Passage	1
NR123417-B	Gasket, Water Pump	1
NR502902-B	Packing, Oil Fill Cap	1
NR136495-B	Gasket, Oil Fill Cover	3

Tier II Cylinder Kit

QRE516227

Cylinder Kit Tier II John Deere
6320 6420 6520 6620 6820
6920



Rod Bolts

Part No.	Description	Qty.	Note
QR114083	Rod Bolt	12	For Con Rods Marked: R123959 (64mm Long)
QR501124	Rod Bolt Long	12	For Con Rods Marked: R500000 (61mm Long)

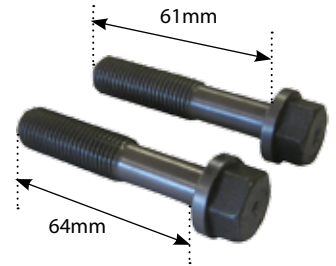

Gaskets

	Part No.	Description	Qty.
1	QRE66083	Head Set	1
2	QRP794	Sump Gasket Set	1

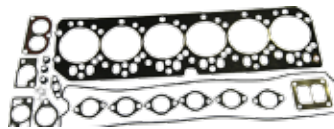

1



2

Valve Kit

Valve Kit 59235 Contains			
	Part No.	Description	Qty.
1	QR98062	Valve, Intake	6
2	QR90692	Valve, Exhaust	6
3	QR85687	Valve Seat, Exhaust	6
4	QR98063	Valve Seat, Intake	6
5	QRE60005	Rotator, Intake & Exhaust	12
6	QR26125	Spring, Valve, Intake & Exhaust	12
7	QR91889	Lock, Valve, Intake & Exhaust	24
8	QRE31617	Cap, Valve Stem	12



For Tractors with 4 Valve Cylinders

	Part No.	Description	Qty.
1	QR502370	Valve, Exhaust	12
2	QR502369	Valve, Inlet	12

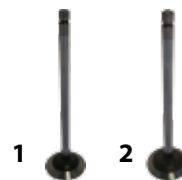

Ring Sets

Part No.	Description
QRE507852	Ring Sets

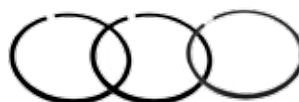

6466T Engine Type

400 Series 466 inches 6 Cylinders



RELIANCE

	Part No.	Description	Bore
1	QRE60288	Cylinder Kit	116
1A	QAR98850	O Ring Kit	
2	QR98845	Gasket Set	
3	QAR77748	Thrust Bearing STD	
4	QAR77747	Thrust Washer Set	
5	QRE22764	Seal Rear Crank	
6	QR26115	Cup Plug, Camshaft	
7	QAR73277	Rod Bearing STD	
8	QR46903	Cam Bushing	
9	QR60724	Gudgeon Bushing	
10	QAR74814	Main Bearing STD	

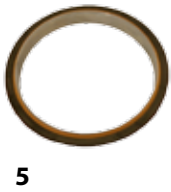



QRE60297
Cylinder Kit Low Ring Engine 6076
Models 4955 4960 8560 8570



QRE60294
Cylinder Kit High Ring Engine 6076
Models 455 4755 7600 7700 7800
8100 8200 8300 8400

6081A High Compression Engines

450 Series 8.1 Litres 6 Cylinders

	Part No.	Description	99700 Standard Overhaul Kit	99710 .010" Kit	Bore
1	QRE64509	Cylinder Kit	6	6	116
1A	QAR98850	O Ring Kit			
2	QRE57187	Gasket Set*	1	1	
3	QAR49025	Seal Front	1	1	
4	QRE61253	Thrust Washer for Flange-less Bearing	1	1	
5	QR87561	Cam Bush	1	1	
6	QR74008	Rod Bush	6	6	
7	QRE520036	Seal Rear	1	1	
8	QR82007	Cup Plug, Camshaft	1	1	
9	QRE504198	Thrust Bearing Pair	1	0	
10	QR525767	Rod Bearing STD	6	0	
11	QRE529319	Main Bearing STD	6	0	
12	QRE504199	Thrust Bearing 10 Thou		1	
13	QRE534185	Rod Bearing 10 Thou		6	
14	QRE534181	Main Bearing 10 Thou		6	



*Gasket Set

Gasket Set QRE57187 Contains		
R83020-B	Gasket, Exhaust Manifold,	2
R83021-B	Gasket, Exhaust Manifold,	2
R88397-B	Gasket, Water Manifold Mount	2
R64840-B	Washer, Inj to Cyl Head	6
R77551-B	O-Ring, Fuel Injector Fitting	6
R51603-B	O-Ring, Fuel Injector	6
R124607-B	Gasket, Thermostat Cover, Dual	1
R102838-B	Gasket, Intake Manifold	3
R86743-B	O-Ring, Aftercooler	1
R50405-B	O-Ring, Intake Coupling	1
R50406-B	O-Ring, Intake Coupling	1
R89879-B	Gasket, Turbo Mount	1
R105346-B	Gasket, Turbo Oil Outlet	1
R86062-B	Gasket, T-Stat Housing to Head	1
R120646-B	Gasket, Intake Manifold	3
R119383-B	Gasket, Water Pump Cover	1
R502011-B	Gasket, Inj Pump Cover	1
R53108-B	Gasket, Starter to Block	1
R119847-B	Gasket, Oil Press Regulator	1
R26058-B	Gasket, C/S Seal Housing	1
R100569-B	Gasket, Oil Pump Intake	1
R132396-B	Gasket, Oil Cooler Cover	1
R50424-B	Gasket, Oil Cooler Adapter	1

R124030-B	Gasket, Oil Cooler Adapter	1
NR100911-B	Seal, Intercooler End	1
NT20328-B	Gasket, Oil Filler Cap	1
NR47153-B	O-Ring, Oil Cooler Tube	8
NU17409-B	O-Ring, Bypass Nut	3
NU13639-B	O-Ring, Coolant Heater Plug	1
51M4237	Washer, Copper	2
51M4238	Washer, Copper	2
R50417-B	Gasket, Oil Cooler to Block	1
R54856-B	O-Ring	1
R109625-B	Gasket, Oil Pump Housing	1
R49866-B	Gasket, Rocker Cover, 404, 466	1
R119384-B	Gasket, Timing Gear Cover	1
R88993-B	Gasket, Intercooler	2
R521228-B	Gasket, Oil Pan	1
RE47336-B	Gasket, Cyl Head, Premium	1

Rod Bolts

Part No.	Description	Qty.
QR501035	Rod Bolt (24mm Long)	12



Gaskets

Gaskets			
	Part No.	Description	Qty.
1	QRE57186	Head Set	1
2	59182	Rocker Cover Gasket	1
3	59183	Rocker Cover Gasket Upper	1

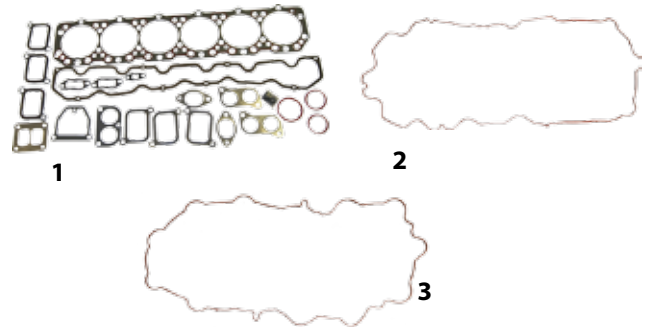

This gasket set includes a cork rocker cover gasket. After Serial No. 200,000 you need to use a 2 piece rubber rocker cover gasket 59182 59183

Valve Kit

Valve Kit 59234 Contains			
	Part No.	Description	Qty.
1	QR84618	Valve, Intake	6
2	QR84619	Valve, Exhaust	6
3	QR91822	Spring, Valve, Intake & Exhaust	12
4	QT20077	Lock, Valve, Intake & Exhaust	24
5	QT20129	Cap, Valve Stem	12

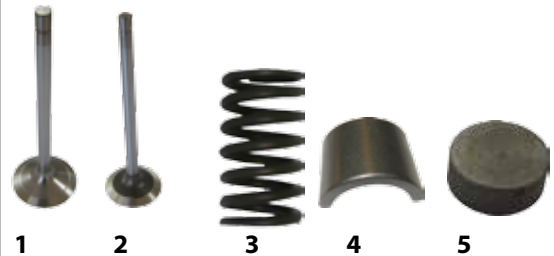

For Tractors with 4 Valve Cylinders

	Part No.	Description	Qty.
1	QR502370	Valve, Exhaust	12
2	QR502369	Valve, Inlet	12

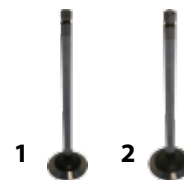

Ring Sets

Part No.	Description
QRE503528	Ring Sets



6068 24 Valve Tier 3 Engines

Part No.	Description
1	QRE524450 Cylinder Kit
2	QRE530613 Piston Ring Set
3	QRE531221 Valve Inlet
4	QR502370 Valve Exhaust
5	QRE527832 Head Gasket Set
6	59568 Valve Seal
7	59569 Valve Spring
8	59567 Seat Exhaust Valve
9	59570 Seat Inlet Valve

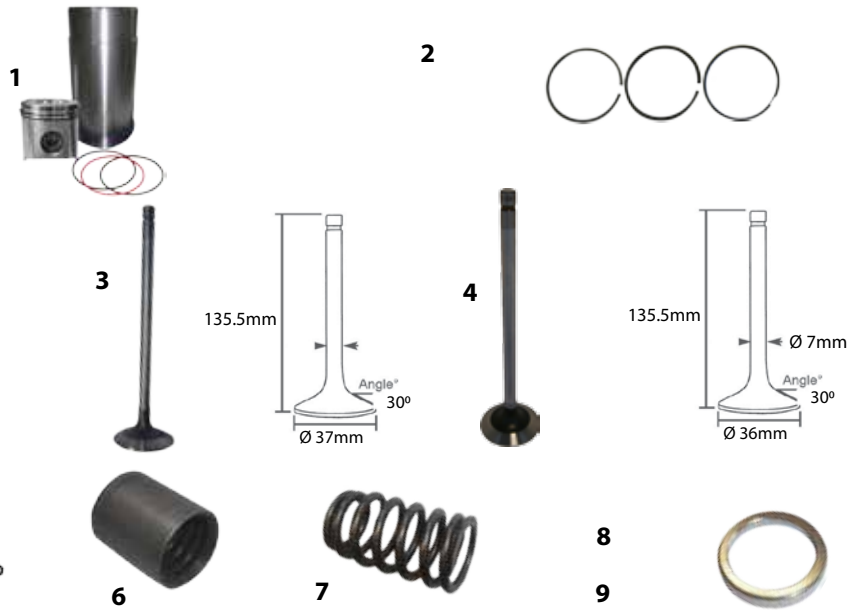

6068 24 Valve Tier 2 Engines

Part No.	Description
1	QRE516227 Cylinder Kit
2	QRE527014 Head Gasket Set

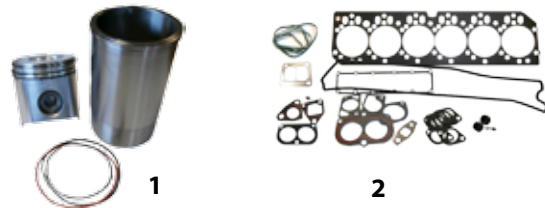

4045 16 Valve Tier 2 & Tier 3 Engines

Part No.	Description
1	QRE524450 Cylinder Kit TIER 3
2	QRE516227 Cylinder Kit TIER 2
3	QRE532842 Head Gasket Set TIER 3
4	QRE526670 Head Gasket Set TIER 2
5	QRE531221 Valve Inlet
6	QR502370 Valve Exhaust
7	59568 Valve Seal
8	59567 Seat Exhaust Valve
9	59570 Seat Inlet Valve

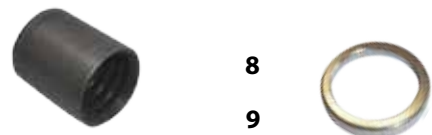
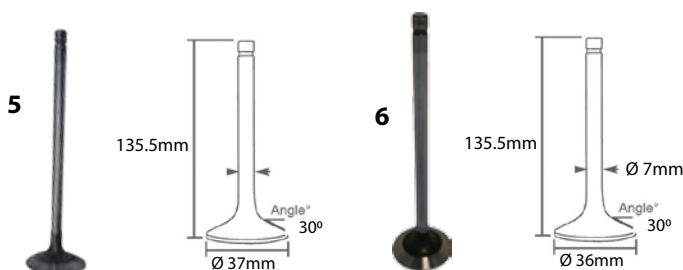
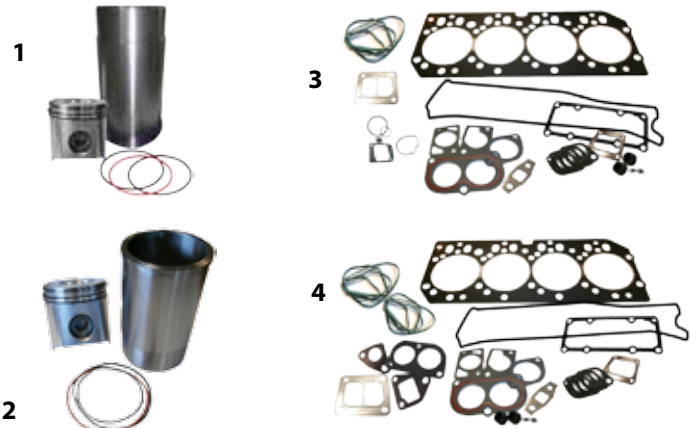

Tier II Engine

Part No.	Description	Qty.
QRE516227	Cylinder Kit 6320 6420 6520 6620 6820 6920	6

OE Ref: RE516227



Part No.	Description	Qty.
QR502370	Valve Exhaust John Deere Powertech 6020 6320 6420 6420S 6520 6620 6820 6920 6920S 6230PR 6330PR 6430PR 6530PR 6630PR 6830PR 6930PR 7220 7320 7420 7520 7720 7820 7430PR 7530PR	12

OE Ref: R502370



Part No.	Description	Qty.
QR502369	Valve Inlet John Deere 6020 Powertech 6320 6420 6420S 6520 6620 6820 6920 6920S 7020 7220 7320 7420 7520 7720 7820	12

OE Ref: R502369



Gasket Sets

2064



Head Gasket Set
John Deere 1020
1030

2052



Head Gasket Set
John Deere 1020
1030 1530 163

59352

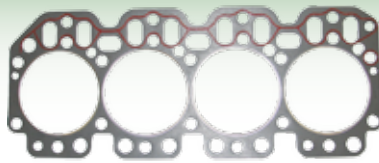

Head Gasket
John Deere 6000
6400

59791



Head Gasket John Deere 3040 - 3640
3050 - 3650 6 Cylinder

59351

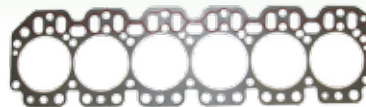

Head Gasket John Deere
6600 6900

2077

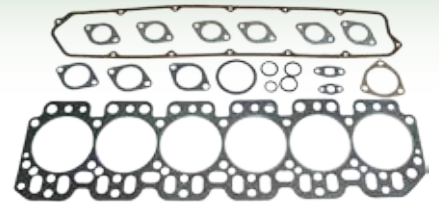

Head Gasket Set John
Deere 3120 3130

59775



Head Gasket John Deere
7700 7800 8000 8100

59792



Sump Gasket John Deere 3050 - 3650 Also fits
3040 - 3640 7600 - 7800 6506 6510 6600 6800
6810 6900 6910



53086
Gasket Maker Red



52866
Gasket Maker Red
Aerosol



3171
Gasket Paper - Cork
1000 x 1000 x 3mm



3167
Gasket Paper -
Plain .8mm



3168
Gasket Paper -
Plain 1 mm

Gasket Sets

59255

Gasket Oil Sump
John Deere 6000
- 6400 6010



59254

Head Gasket Set John
Deere 3200 3210 3300
3310 3400 3410 5500
6100 6100SE 6200
6200SE 6300 6300SE
6400 6400SE

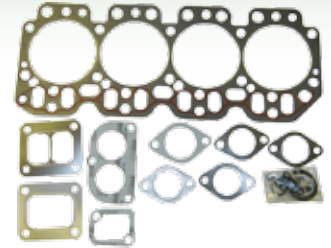

Exhaust Manifold Gasket
John Deere Large Fits
~~59789~~ 7810 6500 - 6900

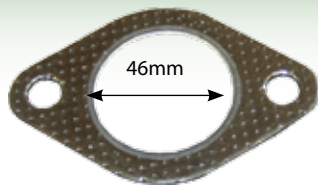

59037

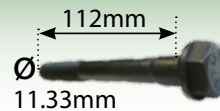

Bolt Cylinder Head John Deere
SET OF **9**
Diameter 11.33mm Length
112mm Thread 1/2 UNC

59605



Cap Screw
Cylinder Head
John Deere 20s
30s 6000 7430
7530

59182

Rocker Cover Gasket
John Deere 6081A 450s
Lower

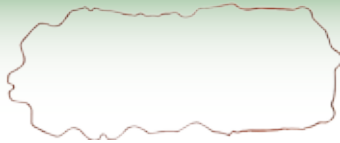

59183

Rocker Cover Gasket John
Deere 6081A 450s
Upper



Crankshafts

59113



Crankshaft John Deere 6 Cylinder
3120 30304030 3135 2840 2940 3040
3140 3340 3640 3640S
4040 4040S 2950 3050 3150 3350
3650 4050 2955 Holes in nose

59228



Crankshaft John Deere 6 Cyl **Taper
Nose** 6510 6910 6520 6920 6530
6930 7430 7530 includes Bearings
and Thrust Washer Hole in nose

59229



Crankshaft John Deere 6 Cyl **Straight
Nose** 6510 6910 6520 6920 6530 6930
includes Bearings and Thrust Washer
Holes in nose

Oil Pump

59230

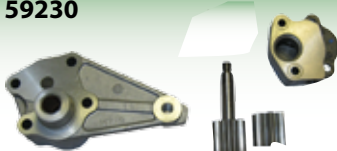

Oil Pump John Deere 6010 - 6910
6020 - 6920 5620 - 5820 6030 - 6930
5080R - 5100R 5080RN - 5100RN

59165

Oil Pump John Deere
2640



59252



Oil Pump John Deere 40s 50s 6000s
4 Cyl 5000s 4 Cyl 3200 3300 Renault

Heat Exchanger

59224

Heat Exchanger 6230 6330 6430
6530 6630 6830 7430 7530

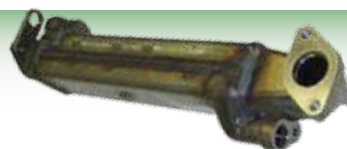

Fuel Components

Fuel Injectors

51469R

Fuel Injector
John Deere
31-3350



51470R

Fuel Injector John
Deere 6100 - 6900
Also Fits John
Deere 5300 - 5500



51471R

Fuel Injector
John Deere
2400 - 2850



59765

Fuel Injector John Deere
6010 Series 6110 - 6910
& 5620 5720 5820 7610
7710 7810 - up to Serial
Number



59765R

Fuel Injector
John Deere
6010 Series
6110 - 6910
& 5620 5720
5820 7610
7710 7810
-up to Serial
Number



Cover Seals

59856

Timing Cover Seal
John Deere 10 20

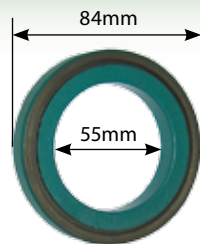

Width 12.7mm

QRE44574

Seal John Deere 40
50 Rear Crankshaft
Also 6000 6010 1020
- 2120 1030 - 3130
4239T 4039T 6359T
4239D 6359D 4045T

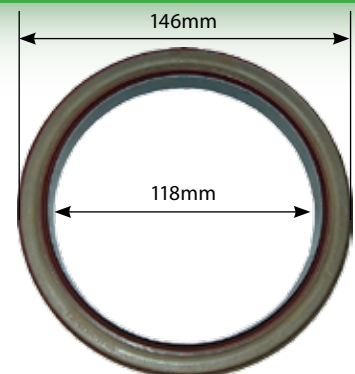

Width 14.5mm

QAR67942

Oil Seal John Deere
1020-3120 1030-4630
3100-3410 40 Series
50 Series 6000 Series
4239D 6359D 4045T
6068T 300 Series

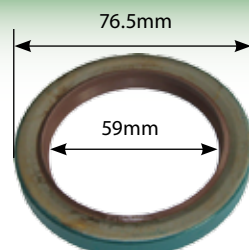

Width 10mm

59300

Seal John Deere Rear
Crankshaft Housing
10s 20s 30s 40s 50s
55s 60s

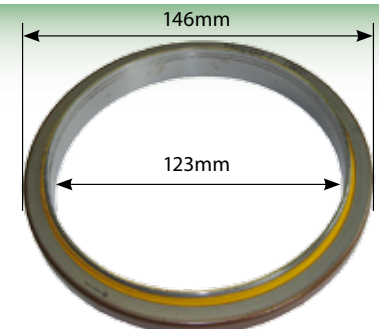

Width 20mm

Fuel Lift Pumps

59933



Fuel Lift Pump John Deere 6000 - 6900 VDO **Fits 6110 up to 6610 & 6120 up to 6620**
For SE and Premium Tractors

59933R

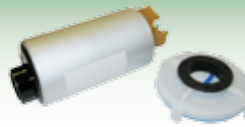

Fuel Lift Pump John Deere 6000 - 6900 **Fits 6110 up to 6610 & 6120 up to 6620**

59310



Fuel Lift Pump Electric John Deere 5620 5720 5820 6020 6120 6220 6320 6420 6520 6620 6820 6920 7520 5415 6215 6415 6515 6615

59520

Fuel Lift Pump John Deere 1030-3130 2140-4040



59457

Lift Pump John Deere 3050 4040s 3350 3650



59609

Fuel Lift Pump John Deere 7210 7410 7510 7630



59261

Fuel Lift Pump Repair Kit 6020 Series



59411

Fuel Lift Pump John Deere 6020 6030 Electric Fits Late 6020 & All 6030 - Premium & SE Also 7430 7530 Series



59816

Fuel Pump John Deere 6010 6020 Electric 6310 - 6910S & 6320 - 6920S
Also 3800 John Deere Telehandler



59333

Diaphragm Kit Delphi Injector Pump 4200 5400
John Deere ** with Metal Centre **



59036

Heater Plug John Deere 50 Series



Fuel Line

59839

Fuel Line John Deere 10 20 - Pump to Filter



42983

Fuel Line Fuel Filter John Deere 6200 6300 6400 6500 6600 6800 6900



Valves

59906

Check Valve Fuel Line John Deere
** 59906R is Replacement Type **



59906R

Valve Non Return 8mm
** 59906 is Genuine **



Sensors

59562

Sensor John Deere 20s 30s Fuel Rail Pressure Oe Ref: RE520930



59561

Valve John Deere 20's Common Rail High Pressure Pump
Oe Ref: RE531864



Fuel Tank Caps

3158



Fuel Cap John Deere
40 50

59436



Fuel Tank Cap John Deere 00 10 20
No Lock

59840



Fuel Tank Cap John Deere 00 10 20
Lockable

Oil Caps

59391



Oil Cap John Deere 3050
3350 3640 2140 1640
2040

59390



Oil Cap John Deere 2040
- 3640 Filler Neck Up To
Serial Number 429999
1350 - 2450 2650 - 3650
All 6000 6010 6020

59401



Oil Filler Cap Engine
John Deere

59076

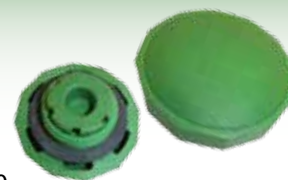

Oil Filler Cap John Deere
6800 6900 6810 - 6910 6820
6920 5620 5720 5820 5080R
5080RN 5090R 5090RN 5100R
5100RN 5070M 5080M 5090M

Rear Straps



59496

Tank Strap John Deere 6000 10 20 Diesel Rear***54.6 GL Tank - Length 805mm***

59497

Tank Strap John Deere 6000 10 20 Diesel Tank
42.2 GL Tank - Length 620mm

59498

Tank Strap John Deere 6000 10 20 Diesel Front
48.9 GL Tank - Length 715mm

59499

Tank Strap John Deere 6000 10 20 Diesel Rear
48.9 GL Tank - Length 665mm

61-6400 (Corner Post System) Late Type 2 Piece

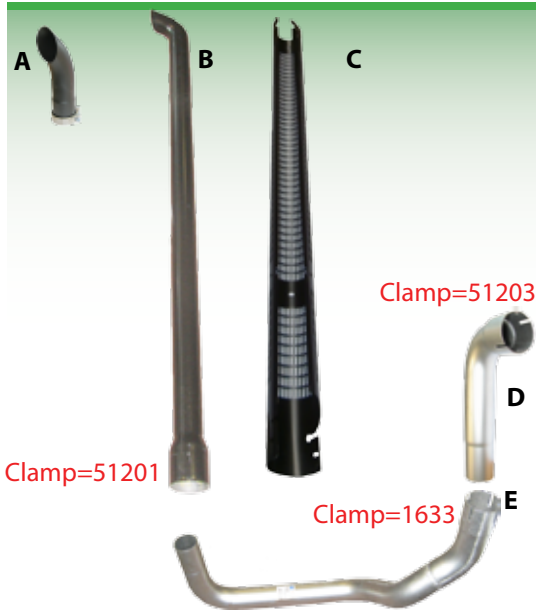

	Part Number	Description	OE Ref:
A	59309	Exhaust Tip John Deere 6000 Series c/o Clamp 65mm	
B	59489	Exhaust John Deere 6100 - 6400 Vertical Pipe Also 6110 - 6410	AL115443
C	59167	Heat Shield John Deere 6010 - 6410 6020 - 6420 5620 - 5720 - 5820 5100M 5080R - 5090R 5080RN - 5090RN 5070M - 5080M - 5090M	
D	59487	Exhaust John Deere 6100 - 6400 To Lower Pipe Also fits John Deere 6110 - 6410 Corner Post Only	L102641
E	59488	Exhaust John Deere 6100 - 6400 Pipe Lower 6110 - 6410 This Suits Only For Corner Post	L102641

6110-6410 (Corner Post System) Late Type 2 Piece

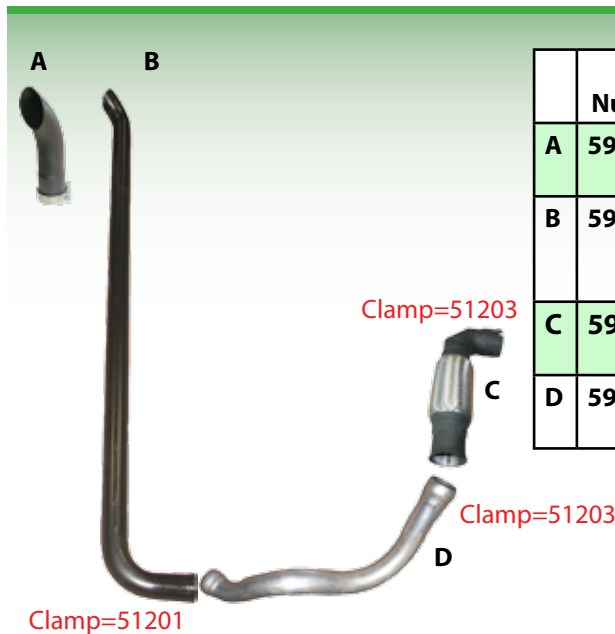

	Part Number	Description	OE Ref:
A	59309	Exhaust Tip John Deere 6000 Series c/o Clamp 65mm	
B	59365	Exhaust John Deere 6010 - 6410 Vertical Pipe From Serial Number 244529 ID 60mm Flange 74mm	AL116902
C	59367	Exhaust John Deere 6100 - 6400 To Lower Pipe 6010 - 6410 From Serial Number 244529	AL155610
D	59366	Exhaust John Deere 6100 - 6400 Lower Pipe 6010 - 6410 From Serial Number 244529	L114990

<p>59934</p> <p>Exhaust John Deere 6000 6010 4 Cylinder **SE only - Not For Corner Post** 65 mm</p> <p>Clamp=51203</p>	<p>59635</p> <p>Exhaust Pipe John Deere 6100 - 6400 Lower From S No.143102 for 6000 6110 - 6410 & SE **Middle of Bonnet With Turbo**</p>	<p>59376</p> <p>Clamp=1637</p> <p>Exhaust Pipe John Deere 6100 - 6400 Under Bonnet 6110 - 6410 SE Models For Silencer Box to Exhaust Pipe - Non Turbo</p>	<p>59244</p> <p>Exhaust Flexi Pipe John Deere 6030 - 6430 4 Cylinder Only</p>
<p>59061</p> <p>Exhaust Pipe Between Flexi & Stack John Deere 6530 - 7530 Deluxe Exhaust System</p> <p>Clamp=51201</p>			

6320-6420 (Corner Post System)



	Part Number	Description	OE ref:
A	59309	Exhaust Tip John Deere 6000 Series c/o Clamp 65mm	
B	59483	Exhaust John Deere 6320 6420 Vertical Pipe	AL164071
C	59482	Exhaust John Deere 6320 6420 Lower Pipe Also fits John Deere 6330	L158904
D	59481	Exhaust John Deere 6120 - 6420 Flexi Pipe 61.3mm ID for Outlet Pipe Length 230mm 61.3mm ID for Outlet Pipe Length 230mm	AL155630
E	59167	Heat Shield John Deere 6010 - 6410 6020 -6420 5620 - 5720 - 5820 5100M 5080R - 5090R5080RN - 5090RN 5070M - 5080M - 5090M	L158903

6600-6900 (Corner Post System)



	Part Number	Description	OE ref:
A	59308	Exhaust Tip John Deere 6000 Series c/o Clamp 76mm	
B	59479	Exhaust John Deere 6506 - 6910 SE Vertical Middle of the bonnet	L112233
C	59758	Exhaust John Deere 6600 - 6900 Upper Pipe Also fits John Deere 6506	AL80953
D	59760	Exhaust Clamp John Deere 6506 - 6900	AL80508
E	59725	Exhaust John Deere 6800 6900 From Exhaust Box Curved from Exhaust Box	L102686
F	59757	Exhaust John Deere 6600 - 6900 Lower **Also 6506**	AL80501

6510-6910 (Corner Post System)



	Part Number	Description	OE ref:
A	59311	Heat Shield John Deere 6510 6610 6510 6610SE 6810 6910 6910S	L113658
B	59508	Exhaust John Deere 6510 - 6910 Corner Post	AL116287
C	59307	Exhaust Tip John Deere 7000 Series c/o Clamp 90mm	
D	59493	Exhaust Box John Deere 6810 6910	AL113911
E	59490	Exhaust Pipe John Deere 6810 - 6910 Flexi 61.0mm ID	AL114384
F	59491	Exhaust John Deere 6810 - 6910 Lower Pipe Also fits John Deere 6510 6610	L113259
G	59478	Flange Weld In John Deere Exhaust Box 6810-69	

Clamp=51203

6520-6920 (Corner Post System)

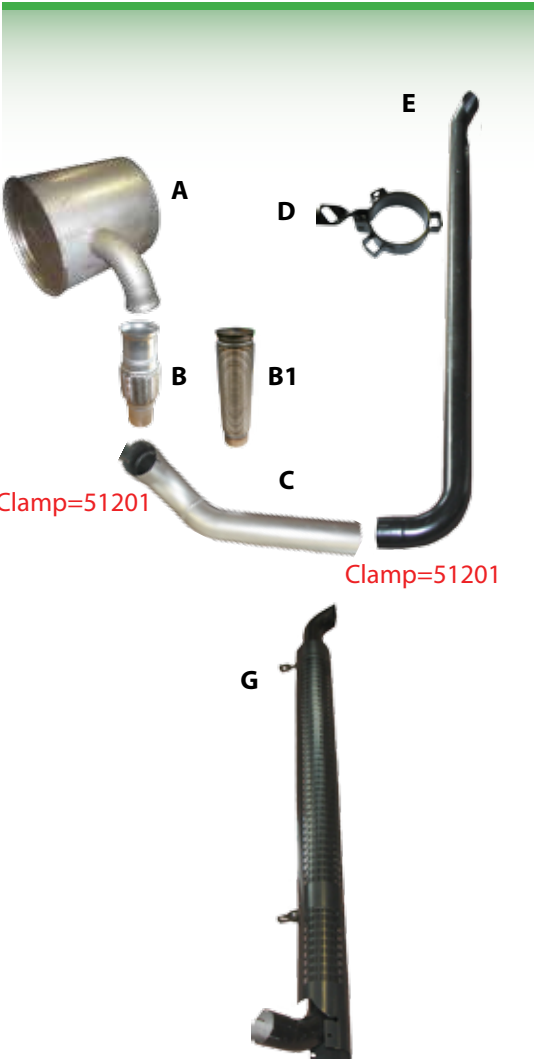

Clamp=51201

Clamp=51201

	Part Number	Description	OE ref:
A	59393	Exhaust Box John Deere 6520 6620 6820 6920	AL153972
B	59484	Exhaust John Deere 6520 - 6920 Flexi Pipe 71.6mm ID	AL151148
B1	59060	Exhaust Pipe Flexi John Deere 6520 - 6920 6530 - 7530 Deluxe Exhaust System	AL175163
C	59485	Exhaust John Deere 6520 - 6920 Lower Pipe	L152948
D	59299	Exhaust Clamp John Deere 6520 - 6920 Also Fits 6530 - 6930 7430 7530	AL155689
E	59486	Exhaust John Deere 6520 - 6920 Vertical Pipe Also Fits 6530 - 6930 & 7430 & 7530	AL155688
F	59307	Exhaust Tip John Deere 7000 Series c/o Clamp 90mm	
G	59625	Exhaust John Deere 6820 6920 Corner Post Complete Includes Pipe Heat Shield & Heat Shield Bracket	AL164277

7000's (Corner Post System)

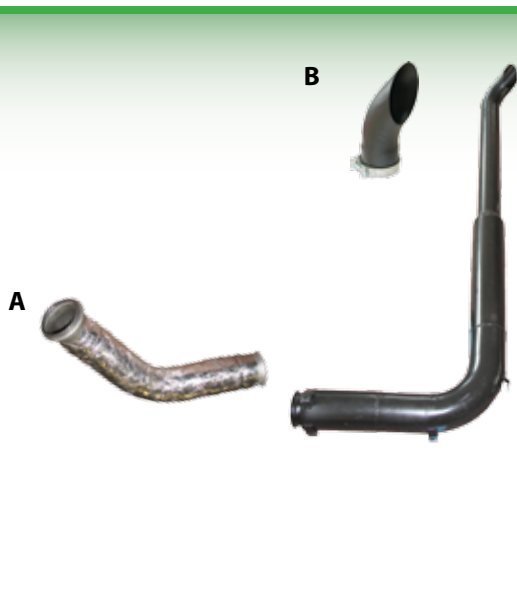

	Part Number	Description	OE ref:
A	59382	Exhaust Pipe John Deere 7710 7810 Lower	RE214148
B	59307	Exhaust Tip John Deere 7000 Series c/o Clamp 90mm	
C	59509	Exhaust John Deere 7000 7600 7700 Fits John Deere 7800 7710 7810 Lower Pipe is 59382	RE175775

Exhaust Systems

Exhaust Pipes

59895

Exhaust John
Deere 830 - 1630
1040 - 2640 (Over
Bonnet) 1020
1120 1350 - 1850



59896

Exhaust John
Deere 1830 2030
2130
(Over Bonnet)
2020 2120



59099

Exhaust John
Deere 40's/50's
Clamp=51203



59480

Exhaust John
Deere 6220 -
6920 Vertical
SE20 + SE 30
Series - Middle of
the Bonnet



59996

Exhaust John
Deere 3050
3350 3650 2650
2850 2040 2140
3040 3140 3640
**Curved End is
58692** 1582 is
Box **

Clamp=51201



58681

Exhaust Box John Deere 1950

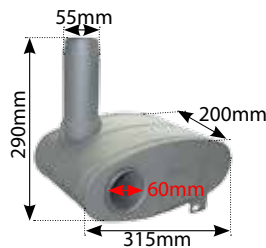

59999

Exhaust Box John Deere 840 940
1040 1140 1550 1750 1850 1850N
1650
Length: 22.5cm. Silencer Ø: 16



4900

Exhaust Box
John Deere
1640 2040 1840
2140 2040S
2250 2450 2650



Gasket=1752

1582

Exhaust Box
John Deere 2140
2850 Turbo Note:
This is Not for 40
& 50 Series Non
Turb



58692

Stack Pipe
3650
Curved
End
Clamp=51201



59899

Exhaust Box
John Deere
3040 3140
3640 3050
3150 3350



58693

Exhaust Box
John Deere
3650



59612

Exhaust Box John Deere
3040 3140 Under Bonnet



Exhaust Systems

Exhaust Boxes

59295



Exhaust Box John Deere 6506 6600 6800 6900 **RH
Corner Post Type**
Suits 6059T 6068T Engines

59761



Exhaust Box John Deere 65 - 69 65-6910 SE **SE
only Not Premium** LH side of Bonnet **

59611

Exhaust Box John Deere
6110 6110SE 6200
6200SE 6210 6210SE
6300 6300SE 6400
6400SE 6410 6410SE
Under Bonnet LH Stack



59610

Exhaust Box John Deere
6110 6110SE 6200
6200SE 6210 6210SE
6300 6300SE 6400
6400SE 6410 6410SE
Under Bonnet RH Stack



Weld In Flanges For Exhaust Boxes

59477



Small

59478



Large



59638





Flange Weld In John Deere
Exhaust Box 7000

Oil Cooler Hoses & Water Hoses

Oil Cooler Hoses

Part No	Model	OE Ref	Type	Diameter (mm)	Hose clip	Photo
59469	6200-6400	R114099	Hose Oil Cooler	15		
59472	6506 6800-6900	R121566	Hose Oil Cooler	19	50997	
59473	6506 6800-6900	R121567	Hose Oil Cooler	19	50997	

Water Hoses

59464	1840-2140 1350-2850	R70737	Hose Bypass	18	50997	
59461	1020-1120 830-1630	T23534	Hose Top	36		
59462	1020-2120 830-2130 840	T22500	Hose Bottom	48	50988	
59459	1640-2140	L34898	Hose Top	37	50991	
59460	1640 -2140	L34921	Hose Bottom	45	50991	
59465	2250-2850	L56296	Hose Top	37	50991	
59468	2250-2850	L56295	Hose Bottom	48	50988	
59471	3040-4040S	L32456	Hose Top	49	50988	
59470	3040-4040S	L34922	Hose Bottom	58		
59467	6200-6900 6506	L111275	Hose Bottom	58	50987	
59466	6200-6400E	L100593	Hose Top	60	50987	
59463	3120 3030 3130	T28426	Hose Bottom	54	50987	
59458	840-1140 1350 344 384		Hose Top			

Hoses Clips

Original Type



Part No	Diameter (""")	Diameter (mm)
50999	5/16" - 15/32"	8-12
50998	3/8" - 5/8"	10-16
50997	15/32" - 3/4"	12-20
50996	5/8" - 1"	16-25
50995	23/32" - 1"	18-26mm
50992	7/8" - 1 3/16"	23-36
50991	1 27/64" - 1 39/64"	36-41mm
50990	1 21/32" - 1 27/32"	42-47mm
59089	1 49/64" - 1 31/32"	45-50mm
50988	1 5/16" - 2 3/8"	40-60mm
50986	2 3/8" - 3 3/16"	60-80
50985	2 3/4" - 3 1/2"	70-90

Standard Type



Part No	Diameter (mm)	TYPE
2340SS	9.5-12	Stainless Steel
2345SS	11-15	Stainless Steel
2346SS	12-20	Stainless Steel
2357	16-25	
2357SS	16-22	Stainless Steel
2364SS	18 - 25	Stainless Steel
2394	23-35	
2394SS	25- 35	Stainless Steel
2396	28-48	
2397SS	30 40	Stainless Steel
2413SS	35-50	Stainless Steel
2426SS	45-60	Stainless Steel
2440	50-70	
2440SS	55-70	Stainless Steel
2441SS	60-80	Stainless Steel
2443	70-90	
2443SS	70-90	Stainless Steel

Small Hose Clips

Part No	Diameter (mm)
59659	11
59660	13
59658	14
59661	17



Heavy Duty Clamp

Part No	Diameter (mm)
51934	122 - 130
51933	113 - 121



Fan Belts



Part No	Length	Air Breaks	Air Con	Models	Tension
59539	2365mm	Yes	No	6810,6910,6910S,6230,6330.	Mech
59540G	190mm	No	No	6810 6910 6910S 6230 6330	Mech
59541	2515mm	Yes	Yes	6310, 6410, 6510, 6610, 6520, 6620, 6130, 6630	Mech
59542	1915mm	No	No	6510,6610,6130,	Mech
59543	1910mm	Yes	No	6820,6920,6920S,6230,6930,	Mech
59544	2375mm	Yes	No	6820,6920,6920S,6230,6930,	Mech
59545	2505mm	Yes	Yes	6820,6920S,6930,	Mech

Fan Belts



Part No	Length	Air Breaks	Air Con	Models	Tension
59907	2190mm	No	Yes	6800 6900	Mech
59907G	2190mm	No	Yes	6800 6900 8PK2190	Mech
59947G	2205mm	No	Yes	6100 6200 8PK2205 Original 6300 6400 6600 & All SE	Mech
59948	2225m	No	Yes	6100 6200 8PK2225 Also fits 6300 6400 6600 2225mm	Hyd
59948G	2225mm	No	Yes	6100 6200 6300 6400 6600	Hyd
59949	1718mm	No	No	6100 6200 6PK1718 6300 6400 6506 6600 Premium 6100 6200 6300 6400 SE models	Mech
59949G	1718mm	No	No	6100 6200 6PK1718 6300 6400 6506 6600 Premium 6100 6200 6300 6400 SE models	Mech
59950	1700mm	No	No	6600 6800 6900 6PK1700 6506 6600 6800 6900 - W/O Air Con	Mech
59950G	1700mm	No	No	66 68 6900 6PK1700 6506 6600 6800 6900	Mech
59889G	1930mm	No	No	6010 6020 4 Cyl 8PK1930 6110 6210 6310 6410 6120 6220 6320 6420	Mech
58676	2200nn	No	No	6800 6900 8PK2200	Mech
59063	2285mm	Yes	Yes	6100 6200 6300 6400 6800 6900	Hyd
59694G	2460mm	No	Yes	6100 - 6610 M/ten 8PK2460 & A/C 6120 6130 SE and Premium Tractors	Mech
59387	2500mm	Yes	Yes	6810 6910 6910S 8PK2500 For 6810 6910 with Air Brake & Air Con 6230 6330 6430 with Air con up to Serial Numb (98-27/64")	Mech
59375	2455mm	No	Yes	6820 c/o Air Con 8PK2455 6820 - 6920S 6230 - 6930	
58675	773mm			Alternator Belt John Deere 6930 - 7530 Premiu	

Fan Belts



Part No	Length	Air Breaks	Air Con	Models	Tension
59321	1120mm	No	No	Fan Belt John Deere 2020 2120 - B44	Mech
59320	1215mm	No	No	Fan Belt John Deere 1020 1120 B59 17 x 1215 1520 2120 1030 1130 1630 2020 2120 1830 2030 X17X12151LP	Mech
59319	1328mm	No	No	3120 3130 3030 - 17 x 132 1640-2040 2040S 2140 X17X1328LP	Mech
59318	1390mm	No	No	2840 3030 3130 X17X1390LP	Mech
59325	1397mm	No	No	B53 2250 - 2850	Mech
59324	1447mm	No	No	Collar Shift 3300 B54 3410 2250 - 2650	Mech
59317	1460mm	No	No	3040 3140 X17X1460	Mech
59323	1473mm	No	No	3100-3210 2350 - 2850 B55	Mech
59322	1540mm	No	No	3050 3350 - B59	Mech

Drive Belt Overview

5020, 5M, 5R Series Tractors (5620-5820, 5070M-5100M, 5080R-5100R)

1

For Tractors **Without** Airconditioning/ Pneumatic Trailer Brake Mechanical Tensioning

5620-5820, 5070M, 5080M, 5080R-5100R	
Part No:	59889G
Length:	1930mm
OE Ref:	L114489

2

For Tractors **With** Pneumatic Trailer Brake Mechanical Tensioning

5100M	
Part No:	59544
Length:	2375mm
OE Ref:	L153281

3

For Tractors **With** Air Conditioning Mechanical Tensioning

5620, 5720, 5070M, 5080M, 5080R, 5090R	
Part No:	58680
Length:	2475mm
OE Ref:	L111601

4

For Tractors **With** Air Conditioning And Pneumatic Trailer Brake Mechanical Tensioning

5820, 5090M, 5100R	
Part No:	59541
Length:	2515mm
OE Ref:	L114468

5090M	
Part No:	59542
Length:	1915mm
OE Ref:	L114488

5820, 5090M, 5100R	
Part No:	59694G
Length:	2460mm
OE Ref:	L111600

5100M	
Part No:	59545
Length:	2505mm
OE Ref:	L153282

5100M	
Part No:	59543
Length:	1910mm
OE Ref:	L153280

5100M	
Part No:	59375
Length:	2455mm
OE Ref:	L155538

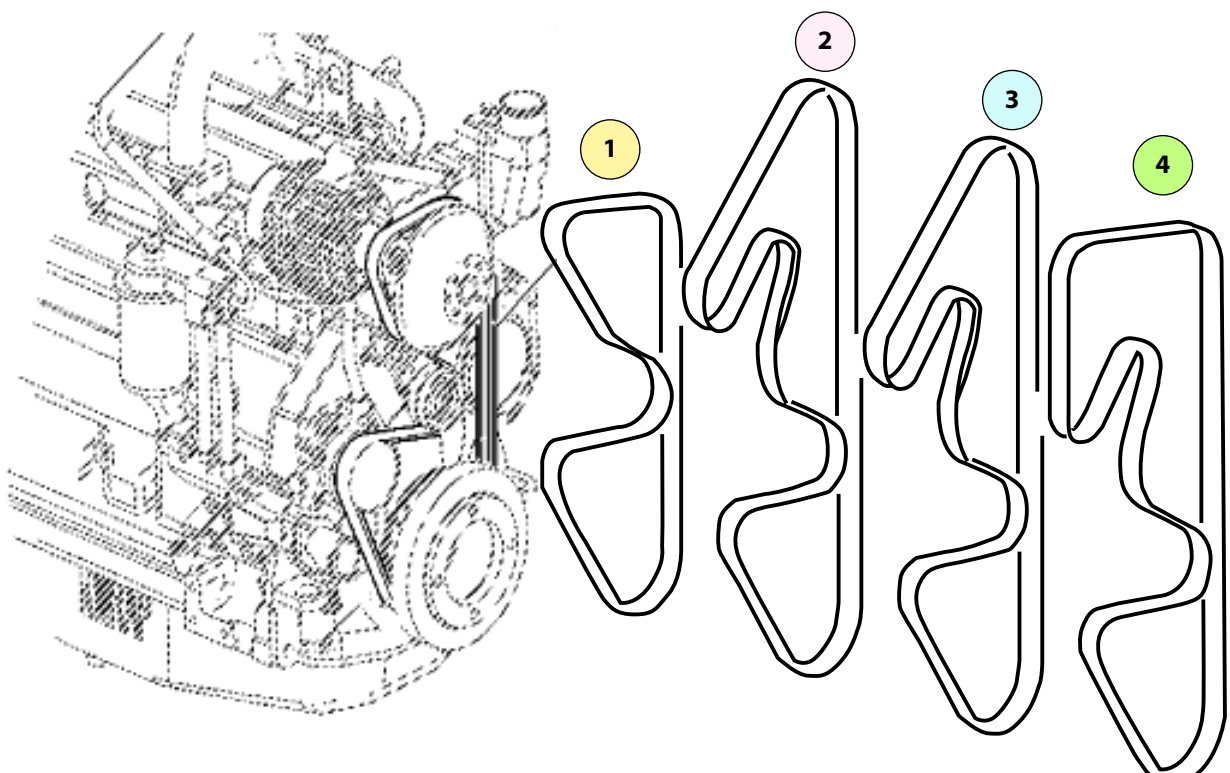

6000 Series (6100-6900, 6100SE-6400SE)

1 Tractors Without A/C Pneumatic Trailer Brake

6100, 6300 Up to Serial No. 125189		6200, 6400 Up to Serial No. 125189		6506, 6600 Up to Serial No.159348		6800, 6900 Up to Serial No. 159348	
Part No:	59949G / 59949	Part No:	59949G / 59949	Part No:	59949G / 59949	Part No:	59950G / 59950
Length:	1718mm	Length:	1718mm	Length:	1718mm	Length:	1700mm
OE Ref:	L111169	OE Ref:	L111169	OE Ref:	L111169	OE Ref:	L110600
Tension:	Hydraulic	Tension:	Hydraulic	Tension:	Hydraulic	Tension:	Mechanical
From Serial No. 125190 Up to 148908		From Serial No. 125190 Up to 148908		From Serial No.159439		6100SE, 6400SE	
Part No:	58677	Part No:	58677	Part No:	59950G / 59950	Part No:	59948G / 59948
Length:	1740mm	Length:	1740mm	Length:	1700mm	Length:	1718mm
OE Ref:	L111148	OE Ref:	L111148	OE Ref:	L110600	OE Ref:	L111169
Tension:	Hydraulic	Tension:	Hydraulic	Tension:	Mechanical	Tension:	Mechanical
From Serial No. 159439		From Serial No. 159439					
Part No:	59948G / 59948	Part No:	59948G / 59948				
Length:	1718mm	Length:	1718mm				
OE Ref:	L111169	OE Ref:	L111169				
Tension:	Mechanical	Tension:	Mechanical				

2 Tractors With Pneumatic Trailer Brake

6100, 6300 Up to Serial No. 159438		Part No: 58676		OE Ref: L101411		Without Viscous Fan Only
Length:	2200mm	Length:	2200mm	Tension:	Hydraulic	

3 Tractors With A/C

6100, 6300 Up to Serial No. 106163		6800, 6900 Up to Serial No. 159438	
Part No:	59907G/59907	Part No:	58676
Length:	2225mm	Length:	2200mm
OE Ref:	L111170	OE Ref:	L101411
Tension:	Mechanical	Tension:	Hydraulic
From Serial No. 159439		From Serial No. 159439	
Part No:	58678	Part No:	59948G / 59948
Length:	2215mm	Length:	2190mm
OE Ref:	L110391	OE Ref:	L111804
Tension:	Mechanical	Tension:	Mechanical
6200, 6400, 6506, 6600 Up to Serial No. 159438		6100SE - 6400SE	
Part No:	59907G / 59907	Part No:	59947G
Length:	2225mm	Length:	2205mm
OE Ref:	L111170	OE Ref:	L110605
Tension:	Mechanical	Tension:	Mechanical
From Serial No. 159439			
Part No:	59947G		
Length:	2205mm		
OE Ref:	L110605		
Tension:	Mechanical		

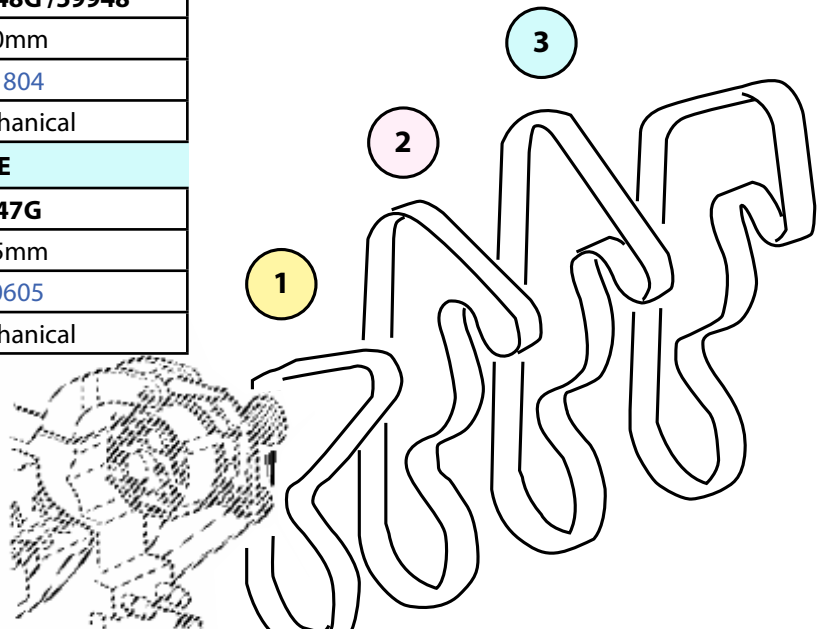

6010 Series Tractors (6010-6910S, 6010SE-6610SE, 6205, 6505)

1	2	3	4
For Tractors Without Airconditioning/ Pneumatic Trailer Brake Mechanical Tensioning	For Tractors With Pneumatic Trailer Brake Mechanical Tensioning	For Tractors With Air Conditioning Mechanical Tensioning	For Tractors With Air Conditioning And Pneumatic Trailer Brake Mechanical Tensioning
6010-6410, 6010SE-6410SE, 6205	6810-6910S	6110, 6210, 6010SE-6210SE	6310-6610, 6310SE-6610SE
Part No: 59889G	Part No: 59539	Part No: 58680	Part No: 59541
Length: 1930mm	Length: 2365mm	Length: 2475mm	Length: 2515mm
OE Ref: L114489	OE Ref: L111801	OE Ref: L111601	OE Ref: L114468

6510, 6610, 6510SE, 6610SE, 6505	
Part No: 59542	
Length: 1915mm	
OE Ref: L114488	

6310-6610, 6310SE-6610SE	
Part No: 59694G	
Length: 2460mm	
OE Ref: L111600	

6810-6910S	
Part No: 59387	
Length: 2500mm	
OE Ref: L114292	

6810-6910S	
Part No: 59540G	
Length: 1900mm	
OE Ref: L114286	

6810-6910S	
Part No: 59387	
Length: 2500mm	
OE Ref: L114292	

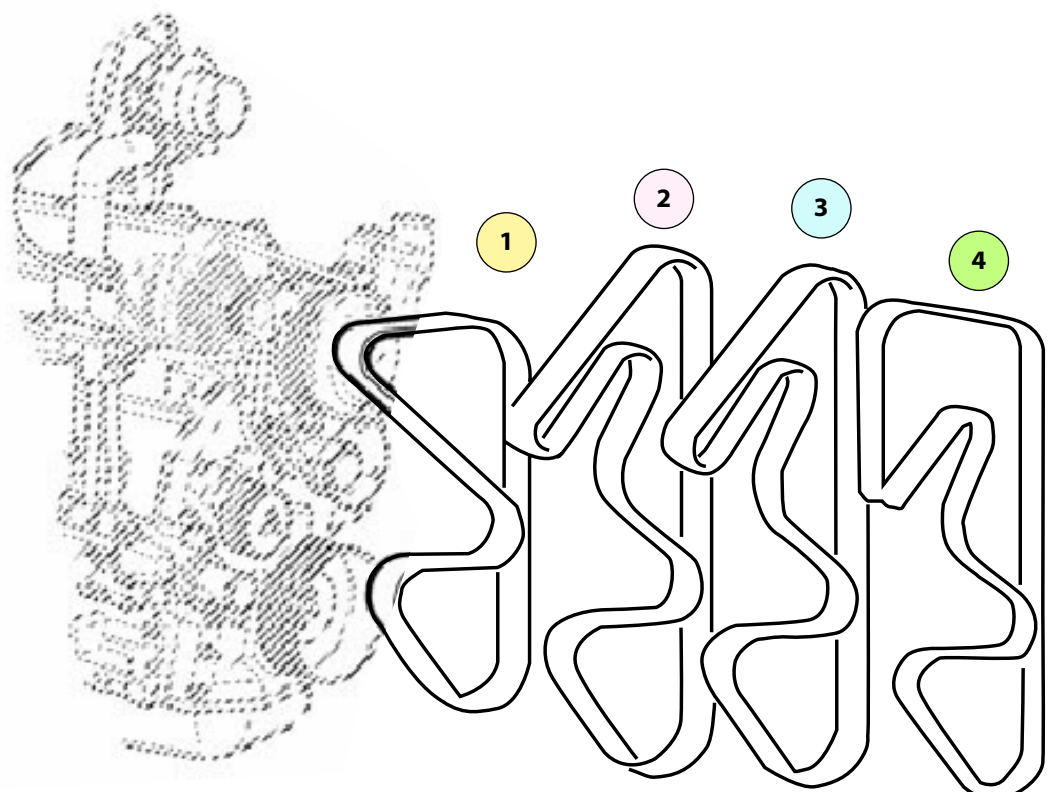

6020 Series Tractors (6020-6920S, 6020SE-6620SE, 6215, 6515)

1	2	3	4
For Tractors Without Airconditioning/ Pneumatic Trailer Brake Mechanical Tensioning	For Tractors With Pneumatic Trailer Brake Mechanical Tensioning	For Tractors With Air Conditioning Mechanical Tensioning	For Tractors With Air Conditioning And Pneumatic Trailer Brake Mechanical Tensioning
6020-6420, 6020SE-6420SE, 6215	6820-6920S	6120-6520, 6020SE-6620SE	6620
Part No: 59889G	Part No: 59544	Part No: 58680	Part No: 59541
Length: 1930mm	Length: 2375mm	Length: 2475mm	Length: 2515mm
OE Ref: L114489	OE Ref: L153281	OE Ref: L111601	OE Ref: L114468

6520, 6620, 6520SE, 6620SE, 6515	
Part No: 59542	
Length: 1915mm	
OE Ref: L114488	

6620	
Part No: 59694G	
Length: 2460mm	
OE Ref: L111600	

6820-6920S	
Part No: 59545	
Length: 2505mm	
OE Ref: L153282	

6820-6920S	
Part No: 59543	
Length: 1910mm	
OE Ref: L153280	

6820-6920S	
Part No: 59375	
Length: 2455mm	
OE Ref: L155538	

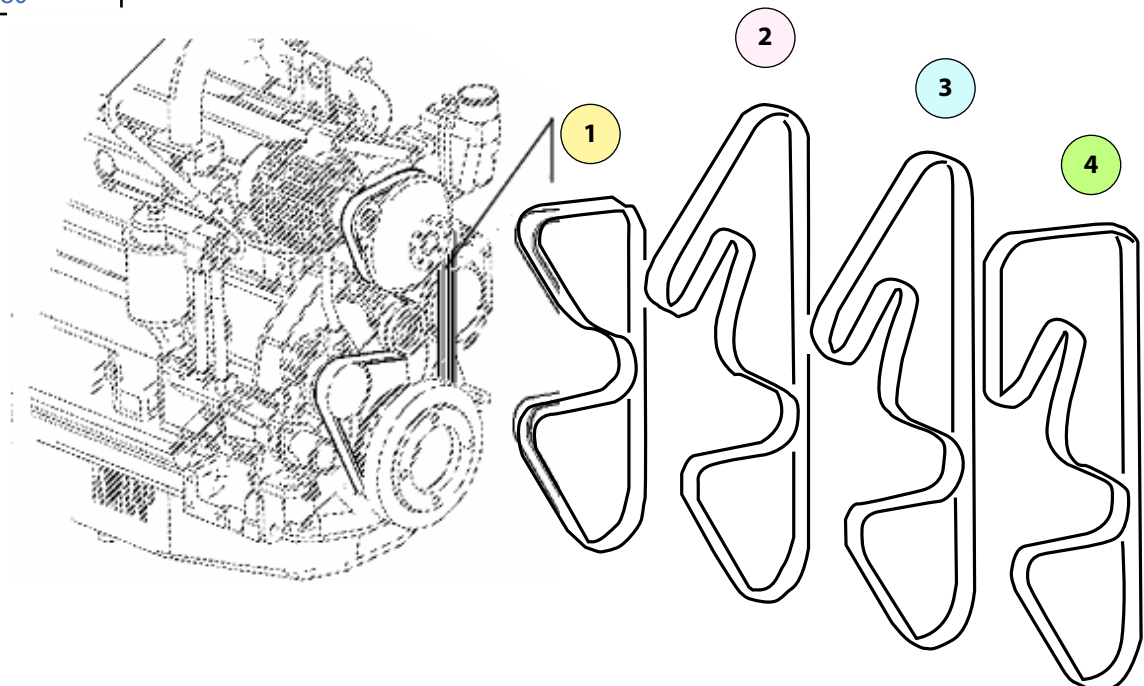

6030 Series Tractors

(6225-6525, 6130-6930, 6230-6930 Premium, 7430 & 7530 Premium)

1	2	3	4
For Tractors Without Airconditioning/ Pneumatic Trailer Brake Mechanical Tensioning	For Tractors With Pneumatic Trailer Brake Mechanical Tensioning	For Tractors With Air Conditioning Mechanical Tensioning	For Tractors With Air Conditioning And Pneumatic Trailer Brake Mechanical Tensioning
6225, 6525, 6130, 6230, 6230 Premium, 6530, 6630, 6530 Premium, 6630 Premium	6130-6430, 6230 Premium, 6330 Premium, 6930, 6830-7530 Premium	6130, 6230, 6230 Premium, 6630, 6630 Premium	6130, 6230, 6230 Premium, 6630, 6630 Premium
Part No: 59542	Part No: 59544	Part No: 59694G	Part No: 59541
Length: 1915mm	Length: 2385mm	Length: 2460mm	Length: 2515mm
OE Ref: L114488	OE Ref: L153281	OE Ref: L111600	OE Ref: L114468

6430 Premium	6430 Premium	6430 Premium	6430 Premium
Part No: 59540G	Part No: 59539	Part No: 59387	Part No: 59387
Length: 1900mm	Length: 2365mm	Length: 2500mm	Length: 2500mm
OE Ref: L114286	OE Ref: L111801	OE Ref: L114292	OE Ref: L114292

6325, 6425, 6330, 6430, 6330 Premium, 6830, 6930, 6830-7530 Premium
Part No: 59543
Length: 1910mm
OE Ref: L153280

6530, 6530 Premium
Part No: 58680
Length: 2475mm
OE Ref: L111601

6330, 6430, 6330 Premium, 6830, 6930, 6830 Premium
Part No: 59545
Length: 2505mm
OE Ref: L153282

6330, 6430, 6330 Premium, 6930, 6830 Premium
Part No: 59375
Length: 2455mm
OE Ref: L155538

6930-7530 Premium
Part No: 58679
Length: 2560mm
OE Ref: L169272

6930-7530 Premium
Part No: 58675
Length: 773mm
OE Ref: L169990

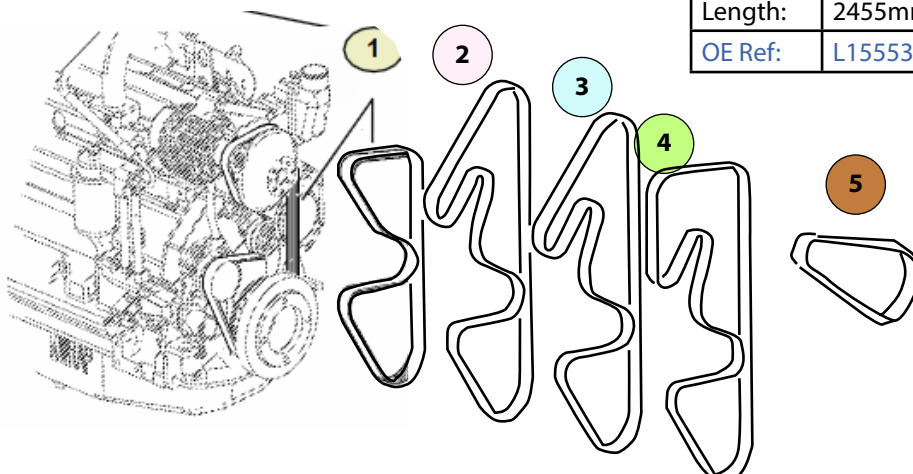

Cooling System

Water Pumps

59814



Water Pump John Deere
300 301 380 400 401 440
440A 440B 480 1020 1520
2020 300B 301A

59163



Water Pump John Deere 830
930 1020 1120 2030 2020
2120 ** Repair Kit 59100 **

59100



Water Pump Repair Kit John Deere
1020 1120 2020 2120 1030 1130
1630 1830 2030 2130 3030 1350
1550 1750 1850 1950

59284



Water Pump John Deere 2020
2030 2040 2240 1020 1030
1130

59812



Water Pump John Deere
3050 3350 3650

60006



Water Pump John Deere
6100 - 6900

59979

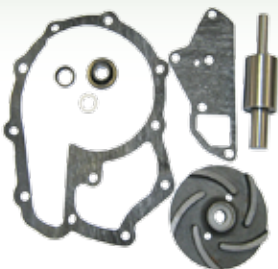

Water Pump Kit John
Deere 3741651140 50's 6 C

59958



Water Pump Kit John Deere 40
50's 4 cyl only 4 Cyl 50's From
795107 to 829915

59095



Water Pump John Deere 2650
2650N 2850 2250
2450 1350 5300 5400 5500

Cooling System

Water Pumps

59866

Water Pump John Deere
6010 6020 6030 Standard
Incl. 59860 Gasket & 59853
Seal** 7610 - 7810



Water Pump
Gasket John Deere
10 20

Gasket = 59860

59859



Water Pump Repair Kit John
Deere 10/20's ** Pump is 59866 **

59213

Water Pump John Deere 8.11
Powertech 6081
7010 7020 7710 7720 7810 7820 7920
7610 7710 7810 8100 8200 8300 8400
8110 8210 8310 8120



59298

Water Pump John Deere
6230 - 7530 Premium
4045 6068 Tier3 Engines



59189

Water Pump John Deere 6076 Engine
** Repair Kit is 59188 **



59188

Water Pump Repair Kit
John Deere 6076
** Water Pump is 59189 **



59253

Water Pump Gasket Outlet
Housing John Deere
6100 - 6900 5300 5400 5500



59092

Gasket Thermostat Housing John Deere
6110 6210 6310 6410 6510 6610 6810
6910 6120 6220 6320 6420 6520 6620
6820 6920 6130 6230 6330



Cooling System

Air Conditioning



59007

Compressor Air Conditioning John Deere 6200 6300 6400 6600 6110 6210 6310 6610 6220 6320 Renault Ares 540 546 550 556 566 610 616 620
OE Ref: [AL153386](#)

59550

Compressor John Deere 6000 6010 6015 6020 L Series 6030 Standard Series 7020s 7030s Renault Ares 540 546 550 556 566
OE Ref: [AL153386](#)



59008

Receiver Dryer John Deere 40 50 6000 6010 7010 Series
OE Ref: [AL77581](#)



Viscous Fans



59002

Viscous Fan John Deere 5080R 5090R 5100R 6225 6325 6525 6130 6230 6330 6430
OE Ref: [AL177841](#)



59001

Viscous Fan John Deere 6505 6010SE 6210SE 6310SE 6410SE 6510SE 6610SE 6010 6110 6110L 6210 6210L 6310 6310L 6310S 6410 6410L 6410S
OE Ref: [AL118091](#)



59618

Viscous Fan John Deere 6520SE 6620SE 6920SE 6520 6620 6820 6920 6920S 7220 7320 7420 7520
OE Ref: [AL155874](#)



59617

Viscous Fan John Deere 6215 6415 6120L 6220L 6320L 6420L 6520L 6020SE 6120SE 6220SE 6320SE 6420SE 6020 6220 6320 6420 6420S 6520
OE Ref: [AL155873](#)



59577

Viscous Fan John Deere 3150 3155 3255 3350
Oe Ref: [AL69178](#)



59615

Viscous Fan John Deere 3050 3350 3055 2955
OE Ref: [AL69177](#)

59000

Viscous Fan John Deere 6100SE 6200SE 6300SE 6400SE 6100 6200 6200L 6300 6300L 6400 6400L 6506 6600 6600 6800 6900 7500 6500L
OE Ref: [AL79618](#)



59619

Viscous Fan John Deere 6100SE 6200SE 6300SE 6400SE 6200 6400 6506 6600 6800 6500L
OE Ref: [AL81448](#)



59616

Viscous Fan John Deere 6910 6910S
OE Ref: [AL111576](#)



59596

Viscous Fan John Deere 7710 7810
RE169092



Thermostat Housing

3163

Thermostat Cap John Deere
90 Degrees 90°



59551

Thermostat Switch John Deere
5220 5320 5520 2940 30 Series
40 Series 50 Series 4560 4570
4960 5210 5310 5410 5510 5220
5320 5520 Case [OE Ref: AL59879](#)



Water Pump Seal

59858



Pump Rod Seal
John Deere
6820/6920

59853



Water Pump Seal
John Deere 10 20
Series

59122



Thermostat Seal
John Deere 30
Series

Compressor

59155



Compressor Air Condition-
ing John Deere 1640 2040
2040S 2140 2250 2270
2280 2320 2350 2355

59552

Evaporator John Deere 2050 8030 30 40 50 55 Series
[OE Ref: AL37526](#)



Thermostats

4398

Thermostat 82°



Thermostat Ford 82° c/o
Pin Case CX70 80 90 3000
Series John Deere 40

2485666

Thermostat 82°



Thermostat 82°
All Models

59083

Thermostat John
Deere 6010 6110
6210 6310 78' 6410
6505 6020 6120 6220
6320 6420 6420S
6520 6620 5620 5720
5820 6920SE 3800
3215 3220



59345

Deere 6820 6920
6920S



59077

Thermostat
John Deere
6020 - 6620
7220 7320



58673

Sensor Coolant
Temperature John Deere
SE6010 - 6410



58672

Sensor Low Water John Deere
5820 Early 6120 6220



Diesel Stop Solenoids

1976



Solenoid 12v Diesel Stop BOSCH

2038



Solenoid Diesel Stop 12V CAV 2 Spade Connections

1992



Solenoid Diesel Stop 12V CAV Single Nut Connection

7778



** USE 1992 ** Solenoid Diesel Stop 12V CAV

62727



Solenoid 12V Diesel Stop 42s 54s Plug In Type

59068

Stopper Cable John Deere 20 30 401200mm



Tensioners

59834

Pulley Tensioner John Deere Hydraulic Belt 61/62/63/64/65/66/68/6900



59080

Pulley Idler Belt John Deere 6010 - 6910 6020- 6920 5620 5720 5820 6130 - 6930 7430 7530 5080R 5080RN 5090RN 5100R 5100RN 5070M 5080M

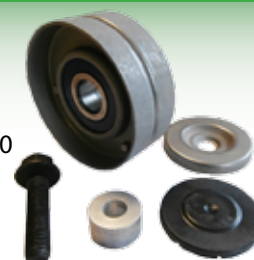

59833

Pulley Tensioner John Deere Mechanical Belt 61/62/63/64/65/66/68/6900

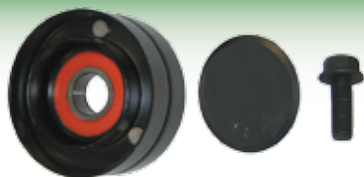

59166

Fan Belt Tensioner John Deere 6100 - 6900



59216R

Fan Belt Tensioner John Deere 6010



59216

Fan Belt Tensioner John Deere 6010



59831

Pulley Tensioner Idler John Deere 6010 6020 6030 ** Tensioners are 59216 & 59215 **



59215

** USE 59215 **



59215R

Fan Belt Tensioner John Deere 6020



Cooling System

Radiators

59372



Radiator John Deere
6506 6600 6800

59373



Radiator John Deere 6110
6200 6210 6310 6410

59374



Radiator John Deere
6200SE 6300 6400

59447



Radiator John Deere
7600 7700 7800
**Also 7710 7810 up to
Serial No. 089999

59475



Radiator John Deere
2250 - 2850 Early
Type for tractors with
no expansion tank

59448



Radiator John Deere
3050 3350 ***Up to Serial
Number 664559***

59476



Radiator John Deere
3050 3350 3650
***From Serial Number
664560***

59370



Radiator John
Deere 6910

59407



Radiator
John Deere
6 Cylinder 20
Series
6520 6620 6820
6920 6920S
SE6320 SE6420
SE6520 SE6620

Hose Kit = 59405

59406



Radiator
John Deere
4 Cylinder
20 Series
Note: 59407
is for some 4
Cylinder SE
models

Hose Kit = 59405

59025



Radiator
John
Deere
6530
6630
6830
6930

59327

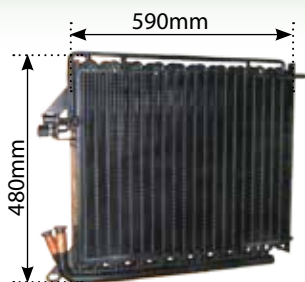

Radiator Oil Cooler John
Deere 4 Cylinder For tractors
with Air Conditioning 6000
6400 6010 6410

59634

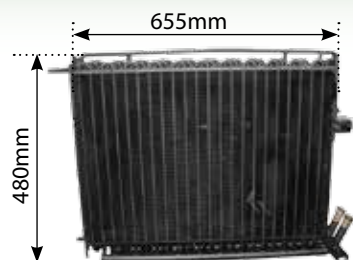

Radiator Oil Cooler John
Deere 6 Cyl 6000 with A/C
6506 6600 6800 6900 & SE
Model 6510 6510 6610 6810
6910 6910S (Core 23")





59085

Oil Cooler John Deere 1640
1840 2040 2140 3040 3140
3340 3640



Cooling System

Radiators Parts

<p>3368</p>  <p>** USE 63405 WHEN STOCK GONE **</p>	<p>59399</p>  <p>Radiator Drain Plug John Deere 6000 6010</p>	<p>59398</p>  <p>Radiator Drain Plug John Deere 6020 6030</p>	<p>59405</p>  <p>Modified Hose Kit John Deere To Suit Oil Cool **To Suit 59407 & 59406**</p>	 <p>59586 Heater Valve John Deere 20 Series OE Ref: AL171742</p>
--	---	---	--	--

Radiator Caps

<p>59389</p> <p>Radiator Expansion Tank Filler Cap 1350-2450 2650-3650</p> 	<p>59392</p> <p>Radiator Expansion Tank Cap John Deere 6000</p> 
<p>59397</p> <p>Radiator Cap John Deere 6000 6010 6020 Filler</p> 	<p>59395</p> <p>Radiator Cap John Deere 4040 4840 4050 15lbs Up To Serial Number</p> 
<p>59394</p> <p>Radiator Cap John Deere 940 3140 1030 1630 2020 2120 3120</p> 	
<p>59402</p> <p>Radiator Cap John Deere 1640 - 3140</p> 	<p>59400</p> <p>Radiator Cap John Deere 7000 - 7020</p> 

Gaskets

3090



Head Gasket Set
IHC 684 784

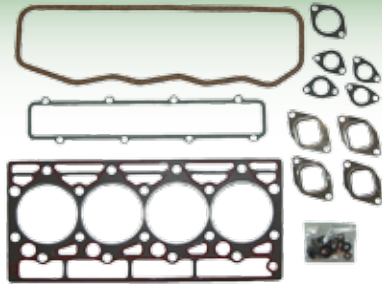

3091

Sump Gasket
Set IHC 684 784

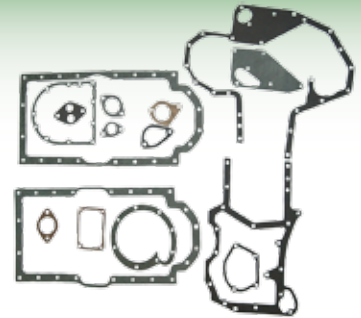

3092



Head Gasket IHC
624 - 844

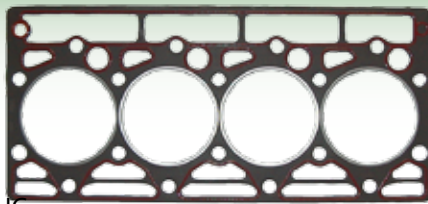

2338

Rocker Cover Gasket IHC 745 844

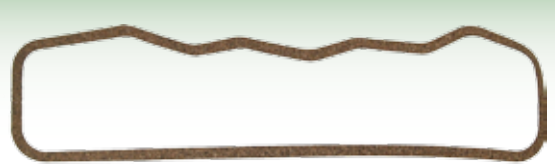

52140

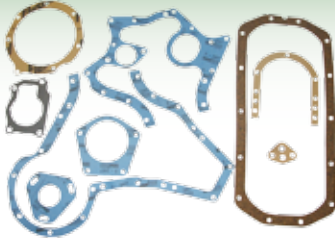

Sump Gasket Set IHC 414 444
Also Fits 434 374 384 & Case

52139

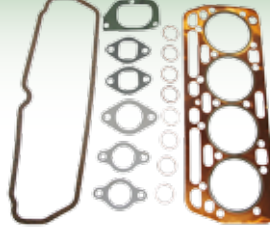

Head Gasket Set IHC 414 444
Also Fits 434 374 384 & Case

53432



Head Gasket Set Case CX100 CX70
CX80 CX90MX100C MX80 MX90X
Ghibli 90 100 Mythos 90 100

Q3804896

Head Gasket Set
Cummins 4B Engine
Case IH 5120 5220

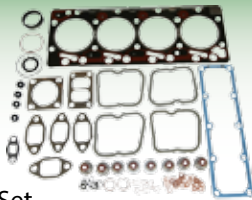

Q3802375

Sump Gasket Set
Cummins 4B Engine
Case IH 5120 5220



Q3938162 Sump Gasket
Cummins 4B Engine Case
IH 5120 5220



Q3804897

Head Gasket Set
Cummins 6B Engine
Case IH 5130 5140 5150
5230 5240 5250
MX100 MX110 MX120
MX135 MX150 MX170



Q3802376

Sump Gasket Set
Cummins 6B Engine
Case IH 5130 5140 5150
5230 5240 5250







Q3959052





Sump Gasket Cummins 6B
Engine Case IH 5130 5140 5150
5230 5240 5250



Engine Components

<p>1436</p>  <p>Engine Kit IHC 884 885 D268 - 100mm Piston & Ring & Liner</p>	<p>1430</p>  <p>Piston & Liner IHC 784 785 844 D246 - 100mm</p>	<p>2108</p>  <p>Ring Gear IHC 484 584 674 784 - 126 Teeth 3210 3220 3230 4210 4220 385 485 585 685 785 885 278 454 474 574</p>	<p>51001</p>  <p>Ring Gear IHC 885 956 42'S 128 Teeth 288 4230 4240 884 885 885XL 895 895XL</p>	<p>52311</p>  <p>Ring Gear Case 844 845 856 955 956 1055 1056 1255 OE Ref: 3144607R1</p>
---	---	--	--	--

Model	Piston	Ring	Liner	Seal
275/276/354 B250	 52136	 52137	 52166	 52179
414 444 434 384 374	C/O Rings 52739		52166	52179

<p>4771</p>  <p>Crankshaft Oil Seal IHC 684 Zetor 9540 Rear 110 x 130 x 12.7mm</p>	<p>3967</p>  <p>O Ring IHC For Liner</p>	<p>52141</p>  <p>Crankshaft Seal IHC 414 444 Front Also Fits 434 374 384 & Case - 73 X 48 X 12</p>	<p>52142</p>  <p>Crankshaft Seal IHC 414 444 Rear Also Fits 434 374 384 & Case -3.63"x4.38"x0.7</p>
--	--	---	---

<p>1253</p>  <p>Timing Cover Seal Kit IHC</p>	<p>1253S</p>  <p>Timing Cover Seal IHC (Only) Front 77mm x 100mm</p>	<p>1129</p>  <p>Exhaust Manifold Gasket IHC</p>	<p>4772</p>  <p>Gasket Rear Crankshaft 684</p>
---	--	--	--

<p>Q3901306</p>  <p>Cam Bush Cummins 4B 6B Engine ** 1 Per EngineCase IH 5130 5140 5150 5230 5240 5250MX100 MX110 MX120 MX135 MX150 MX1705120 5220</p>	<p>Q4891178</p>  <p>Gudgeon Pin Bush Cummins 4B 6B Series EngineGudgeon Pin Bush Cummins 4B 6B Series Engine Case IH 5130 5140 5150 5230 5240 5250 MX100 MX110 MX120 MX135 MX150 MX170 5120 5220</p>	<p>Q3900709</p>  <p>Crank Seal Front Cummins 4B 6B EngineCase IH 5130 5140 5150 5230 5240 5250MX100 MX110 MX120 MX135 MX150 MX1705120 5220</p>	<p>Q3933262</p>  <p>Rear Seal Cummins 4B 6B EngineCase IH 5130 5140 5150 5230 5240 5250MX100 MX110 MX120 MX135 MX150 MX170 5120 5220</p>
--	--	---	--

Engine Components

52609

Cylinder Head IHC 414



52608

Combustion Cap
IH 414



52284

Crankshaft Case IH 74
Series 84 Series 3484 276 354
434 444 B250 B275 B414
OE Ref:3110995R91



52180

Crankshaft IHC 554 584
624 654 595XL 733 740
c/o Balancer Gear Ring



Cummins B Rod Bearings



Q3939859	Standard
Q4932375	.25 mm
Q4932376	.50 mm

Cummins 4B Main Bearing Set



Q3802010	Standard
Q3802011	.25 mm
Q3802012	.50 mm

Cummins 6B Main Bearing Set



Q3802070	Standard
Q3802071	.25 mm
Q3802072	.50 mm

Main Bearings

Model	Standard	10 Thou	20Thou
554	52187	52188	52189

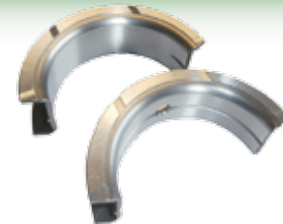

2135

Engine Oil Pump IHC 4 Cylinder
4120 4230 4240 574 584 585 595 674
684 685 695 784 884 885 895



Q3937404

Oil Pump Cummins B Series
Case IH 5130 5140 5150
5230 5240 5250 MX100
MX110 MX120 MX135
MX150 MX170



Q3957543

Oil Cooler Cummins B Series 4B
Only



Engine Components

Q3802060 Piston Standard Non Turbo Cummins B Series Case IH 5130 5230 Engine 6-590	Q3802062 Piston 0.50mm Non Turbo Cummins B Series Case IH 5130 5230 Engine 6-590	Q3802100 Piston Standard Turbo Cummins B Series Case IH 5140 5150 5120 6590	Q3802102 Piston 0.50mm Turbo Cummins B Series Case IH 5140 5150 5120 6590	Oil Holes



Q3802160 Piston Standard Turbo Cummins B Series Case IH 5120 5140 5150 5220 5240 5250	Q3802132 Piston 0.50mm Turbo Cummins B Series Case IH 5120 5140 5150 5220 5240 5250	Oil Holes	Q3802747 Piston Standard Turbo Cummins B Series Case IH MX100 MX110 MX120 MX135 MX150 MX170	Q3802764 Piston 0.50mm Turbo Cummins B Series Case IH MX100 MX110 MX120 MX135 MX150 MX170

Q3802040 Ring Set Standard Non Turbo Cummins B Series Case IH 5130 5230 Engine 6-590	Q3802042 Ring Set 0.50mm Non Turbo Cummins B Series Case IH 5130 5230 Engine 6-590	Q3802421 Ring Set Standard Turbo Cummins B Series Case IH 5120 5140 5150 5220 5240 5250 MX100 MX110 MX120 MX135 MX150 MX170	Q3802422 Ring Set 0.50mm Turbo Cummins B Series Case IH 5120 5140 5150 5220 5240 5250 MX100 MX110 MX120 MX135 MX150 MX170

Q3904166 Block Cylinder Repair Sleeve Cummins B Series Case IH 5120 5130 5140 5150 5220 5230 5240 5250 MX100 MX110 MX120 MX135 MX150 MX170	Q3802356 Valve Exhaust Cummins B Engine Case IH 5120 5130 5140 5150 5220 5230 5240 5250 MX100 MX110 MX120 MX135 MX150 MX170	Q3802355 Valve Intake Cummins B Engine Case IH 5120 5130 5140 5150 5220 5230 5240 5250 MX100 MX110 MX120 MX135 MX150 MX170	Q3900276 Valve Spring Exhaust & Intake Cummins B Engin Case IH 5120 5130 5140 5150 5220 5230 5240 5250 MX100 MX110 MX120 MX135 MX150 MX170

Exhausts

<p>51011</p>  <p>50mm 940mm 50mm</p> <p>Exhaust IHC 414 444 48mm Inlet B275 276 354 374 384 2276 3434</p>	<p>3108</p>  <p>Exhaust IHC 574 Black 454 474 475 574 674</p>	<p>52769</p>  <p>630mm 60mm 60mm 1700mm 80mm</p> <p>Exhaust Case CX90 c/o Stack Pipe Corner Post System</p>	<p>3110</p>  <p>50mm 1300mm 60mm</p> <p>Exhaust IHC 584 - 784 Enamel 395 484 485 495 584 585 595 684 685 695 784 785 795 884 885 895</p>
---	---	--	--

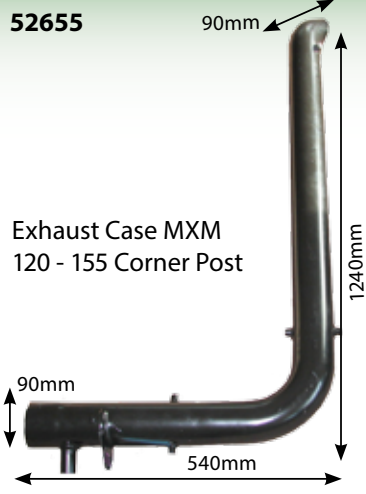
<p>52055</p>  <p>Exhaust IHC 644 744 844 845 440 540 640 644 740 743XL 744 840 844 844S 844XL 845XL 940 4210 4220 4230</p>	<p>52206</p>  <p>50mm 1320mm 80mm</p> <p>Exhaust IHC 46 946 1046 55 955 56 856 956 1056 6 Cylinder</p>	<p>52655</p>  <p>90mm 1240mm 90mm 540mm</p> <p>Exhaust Case MXM 120 - 155 Corner Post</p>
---	---	---

<p>42083</p>  <p>Exhaust Box Ford TSA MXU Clip Type T6030 T6050 T6070 TS115A TS125A TS130A TS135A</p>	<p>53345</p>  <p>Exhaust Case IH 5120 5130 5140 5220 5230 5240 5250</p>	<p>52099</p>  <p>Exhaust Case Maxxum 5140 5150 5130 5230 5240 5250</p> <p>53344</p>  <p>Exhaust Box Case IH 5120 5220</p>
---	---	---

Exhaust Elbow & Manifold

52718



Exhaust Manifold IHC 885
Elbow to suit is 52723

Gasket=1129

52214



Exhaust Elbow Gasket IH Case 885

52723



Exhaust El-
bow IHC 885
Suits 52718



52241

Exhaust Manifold Case IH 544 553 654
664 724 744 824 844

52242



Exhaust Manifold Gasket Case IH 544
553 654 664 724 744 824 844

52711

Exhaust Manifold IHC 784



52233



Exhaust Elbow Case IH
553 654 724 824

52234



Exhaust Elbow Case IH
644 744 844

52235



Exhaust Elbow Case IH
743 745 844 845

52236



Exhaust Elbow Case IH
955 1055 956 1056

52238



Exhaust Elbow Case IH 433 533
633 733 833 933 440 540 640
780 840 940

52237

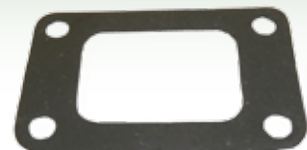

Exhaust Elbow Gasket Case IH 955
1055 956 1056

Fuel Tank Caps

59840



Fuel Tank Cap
00/10/20's Lockable

59436



Fuel Tank Cap 00/10/20's
No Lock

2663



Fuel Tank Cap IHC

52697

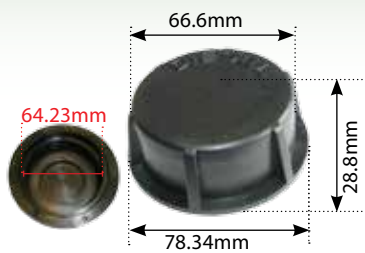

Fuel Tank Cap IH 42's
Seal=52698

52224



Fuel Tank Cap Case JX55 JX60 JX65 JX70 JX75 JX80
JX80 MXM120 MXM130 MXM140 MXM155 MXM175
MXM190 MXU100 MXU110 MXU115 MXU125 MXU135

52225



Fuel Cap Case JX1060C JX1070C
JX1070U JX1075C JX1080U JX1085C
JX1095C JX55 JX60 JX65 JX70 JX70U
JX75 JX80 JX80U JX85 JX90 JX95
MXM120

52227



Fuel Cap Ford TL100 TL65
TL70 TL80 TL90 TM135
TM150 TM165 TM180

Fuel Parts

Fuel Sender Units

52019



Fuel Sender Unit
IHC 32s 42s 3210
3220 3230 4210
4220 4230 4240

52015



Fuel Sender
IHC 784

52182



Fuel Sender Case
IH 743XL 745XL
744XL 856XL

52181



Fuel Sender Case
IH 485XL 495XL
585 585XL 595

1049



Glass Bowl 9mm
Bosch System
(Small)
Washer=922165

922165



Washer - Under
Glass Bowl



52303
Hose Fuel Tank Case
1055XL 955XL 1056XL
956XL OE Ref:3399191R1

2722



Throttle Cable IHC 885 XL 42 Series
1450mm Hand Throttle

3922



Fuel Tank Tap
IHC Brass

59808



Hand Primer Pump Case 4240/
John Deere 14.5 mm hole

Q3802338

Injector Cummins B Series

Q3280048

Injector Cummins B Series

Q3802677

Injector Cummins B Series

Cooling System

Water Pumps

2700



Water Pump IHC 1055XL 1056 1255
1455 743 744 745S 745XL 833 840
940 946 955

52037



Water Pump IHC 414

4345



Water Pump IHC 884 - 885 112mm
Impeller 454 474 484 685 XL 784 785
395 395XL 495 495XL 595 595XL 695
695XL 795

41029

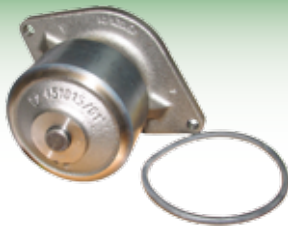

Water Pump Case Maxxum MX
Cummins Engine New Holland
TSA / T Series 148mm Centre Hole
78mm Impeller

52800



Bearing Viscous Fan Case MX100
MX110 MX135 Also MX150 MX170
MX210 MX230 Suits Cummins
Engine 580K SK580 SK590

52725



Water Pump IHC T6 I6 W6 O6 400
Gas/Diesel M W6 Super M Super MTA
400 W400 450 W450

41313227



Water Pump 698T 300
- 78mm Impeller 365
375 390 390T 398 4225
- 4255 6120 - 6150

52083



Water Pump Case CX70 CX80 CX90
CX100 Serial No JJE1008569 Up -
97mm Impeller

Water Pump Gasket=52084

36866721



Water Pump Gasket 165
290 ** Pack of 2 **
For 41313227 Water Pump

52084

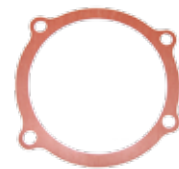

Water Pump Gasket Case
CX70 CX80 CX90
For 52083 Water Pump

Fuel Lift Pumps

52857



Fuel Lift Pump IH
275 414 434 454

53197



Fuel Lift Pump IHC 743
844 745 845 1055 1255
1455 955 1056 856 956

52791



Fuel Pump Case
MX / MTX
MX100 MX110 MX120
MX135 MX150 MX170
MTX110 MTX120 MTX135

51477



Fuel Lift Pump
Cummins B's -
Diaphragm Pump
Case Maxxum 5120
5130 5140

Cooling System

52665



Hose Top IH
275

52681



Hose Water Pump IHC
323 - 1046

52666



Hose Top IH 354 374 - 384 - 444 238

52670



Hose Top IH
385 454 484

52669



Hose Bottom IH
385 395 454 - 495
238 248

2145



Hose Bypass IHC
414 - 444 - 1813

52668



Hose Bottom IHC
250 - 354 414 - 444
374 384 3

52675



Hose Bypass IHC 250 -
354 414 - 384 3434 238

52680



Hose Top IH 276
414-434 3434

52682



Hose Top IH 433-
633 440-640

52683



Hose Bottom
IHC 433 - 833
440 - 940 1046

52673

Hose IHC 454 574
674 Water Pump



4668



Hose Kit IHC 474-885

2144



Hose IHC 474 - 895 Bottom
1811 258-288

2143



Hose Radiator IHC
474 - 885 Top 1810

Cooling System

52671



Hose Top IH
5120 - 5150

52672



Hose Bottom IH
5120 - 5150

52677



Hose Top IH 523,
624-645, 724-745S,
844-845,

52678



Hose Bottom IH
523 624 - 645 724
-745S 844-845

52676



Hose Top IH
955 1055-1056
1246 1255 1455

52688



Hose Top IH 956
1056

52674



Hose Water Pump
IHC 385 - 995 395 -
885 IHC 3210 - 4230

52667



Hose Top IH 995
3210 3220 4240

52684

Hose Top IH 1690 1594
1694



52679



Hose Bottom IH
3210 3220 3230
4210 4220 4230

52685



Radiator Hose
IHC 3210 3220
4240 Top

52686



Radiator Hose IHC
3230 - 4230 Top

52687



Hose Manifold IH CX
70-100 MX 80C-100C

Air Conditioning

52268

Pressure Switch
Case IH MXM
Series New



52269

Blower Switch Case IH 30 2+2
Series 1000s 30s 32s 3200 Utility
4200 Utility 43s 44s 45s 46s 50s
55s 86s CX Series International
MX

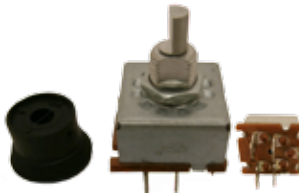

42187

Compressor Ford TM Air
Conditioning 8160 8260
8560 M100 M115 M135
M160 TM115 TM120 TM125
TM130 TM135 TM140
TM150 TM1 **MXM 140**



52270

Compressor Air Conditioning
Case IH 1000s 4200 Utility 85s 85
Utility 95 Utility CS CX Maxxum
Series MX Series Combine 2344
2388



52232

Compressor Case IH 140
Maxxum 100 MXU100
MXU110 MXU115 MXU125
MXU130 MXU135 Maxx-
um140 Ford TS100A
TS110A TS115A TS125A
TS130A



52274

Viscous Fan Case MX100 MX110
MX120 MX135 MTX110 MTX140



Hoses Clips

Original Type



Part No	Diameter (""")	Diameter (mm)
50999	5/16" - 15/32"	8-12
50998	3/8" - 5/8"	10-16
50997	15/32" - 3/4"	12-20
50996	5/8" - 1"	16-25
50995	23/32" - 1"	18-26mm
50992	7/8" - 1 3/16"	23-36
50991	1 27/64" - 1 39/64"	36-41mm
50990	1 21/32" - 1 27/32"	42-47mm
59089	1 49/64" - 1 31/32"	45-50mm
50988	1 5/16" - 2 3/8"	40-60mm
50986	2 3/8" - 3 3/16"	60-80
50985	2 3/4" - 3 1/2"	70-90

Small Hose Clips

Part No	Diameter (mm)
59659	11
59660	13
59658	14
59661	17



Heavy Duty Clamp

Part No	Diameter (mm)
51934	122 - 130
51933	113 - 121



Standard Type



Part No	Diameter (mm)	TYPE
2340SS	9.5-12	Stainless Steel
2345SS	11-15	Stainless Steel
2346SS	12-20	Stainless Steel
2357	16-25	
2357SS	16-22	Stainless Steel
2364SS	18 - 25	Stainless Steel
2394	23-35	
2394SS	25- 35	Stainless Steel
2396	28-48	
2397SS	30 40	Stainless Steel
2413SS	35-50	Stainless Steel
2426SS	45-60	Stainless Steel
2440	50-70	
2440SS	55-70	Stainless Steel
2441SS	60-80	Stainless Steel
2443	70-90	
2443SS	70-90	Stainless Steel

Radiators

52375



Radiator IH Early 248-484,845-885 & XL 595-995 & XL - Late Type 52126 52165 is Up to 1987

52165



Radiator IH Early 248-484,845-885 & XL 595-995 & XL - (Late Type 52126) ** Up to 1987 **

52126



Radiator IHC Late 268,88,485-885 & XL 595-995 Early Type is 52165
Cap = 52020

52770



Radiator IH 956
1056 XL

52248



Radiator IH 1255 - 1455
OE Ref: 3226796R92

52771



Radiator IH
5120 5150

52772



Radiator IHC MX100 MX110 MX120
MX135 MX150 MX170 4 Row IH rad

52246



Radiator Case CX50 60 70 80 90
OE Ref: 222890A5

52249



Radiator IH B275 B414 434
OE Ref: 3107749R91

52020



Radiator Cap
IHC c/o Cover

52133



Radiator Cap
IHC Round

4398



Thermostat Ford 82,
c/o Pin Case CX70 80 90
3000 Series John Deere
40 Ford 40 60 M TM TS



52291
Radiator IHC B275 B414
International 434 444
OE Ref: 1082414R91

Fan Belts

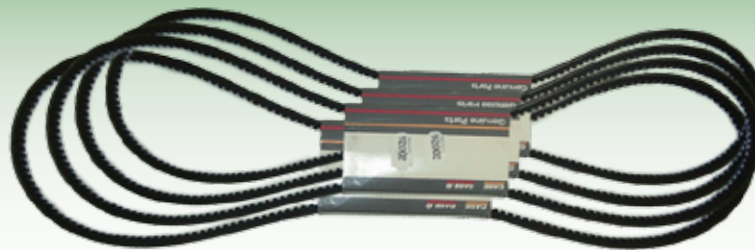

Part No	Models	OE Ref	Size
1509	Fan Belt IHC 474 784	3616512M91	3X1550
52002	Fan Belt Case 956/1056 w/o Air Conditioning	3218952R1	13 x 1420
52006	Fan Belt Case 4240	1537104C1	13 x 1595
52000	Fan Belt Case Maxxum 5120 5130 MX 100 135 (1498mm) MX 100 - 135	J911558	
52000G	Fan Belt Case Maxxum 5120 5130 MX 100 - 135 8PK1495	J911558	
52085	Air Con Belt Case CX70 CX80 CX90	228332A2	
59368	Fan Belt Case IH 323 383 423 453 484 540 640 740 743	3144678R1	
52776	Fan Belt Case C90 CX90 C100 CX100	241895A2	10 X 1415
52775	Fan Belt Case Magnum 7120 7150 7210 7250 8PK1700	J911567	
52774	Fan Belt Case MX150 MX170 - 5130 5140 5150 8PK1460	J911558	

Fan Belt Tensioner

52221

Fan Belt Tensioner Case IH 5120 5130 5140
5150 5220 5230 5240 5250 7110 7120 7130
7140 7150 7210 7220 7230 7240 7250 8910
8920 8930



Gaskets

7804

Gasket Engine Front
Timing Cover Fiat 450
640



7104

Head Gasket Fiat
90-90

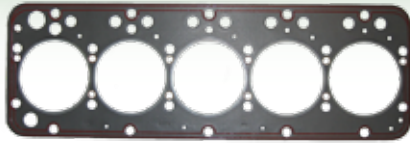

7106

Head Gasket Fiat
110/115/130/140-90



7103

Head Gasket Fiat 880/90-90
(5 cyc)



Sealant & Gasket Paper

7107

Rocker Cover Gasket
Fiat 90 6 Cylinder



1861108



Silicone Sealer -
80ml

1475



Silicone Sealer
300ml

1861117



Gasket Sealer -
100g

1478



Gasket Sealer
350g

Plain Gasket Paper

Sold Per Metre

3167 - 0.80 mm Paper
3168 - 1.00 Paper

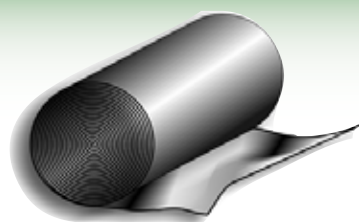

Cork Gasket Paper

Sold Per Metre

3171 - 3 mm Cork

Engine & Crankshaft Parts



- 1. **7540** Dipstick Fiat (100-90, 110-90 Engine)
- 2. **7541** Dipstick Fiat 80/90
- 3. **7542** Washer Fiat for Dipstick
- 4. **7565** Engine Oil Filler Cap Fiat 100/90, Case JX, U
- 5. **7567** Oil Filler Cap Gasket Fiat 100/90
- 6. **7805** Dipstick Fiat L95

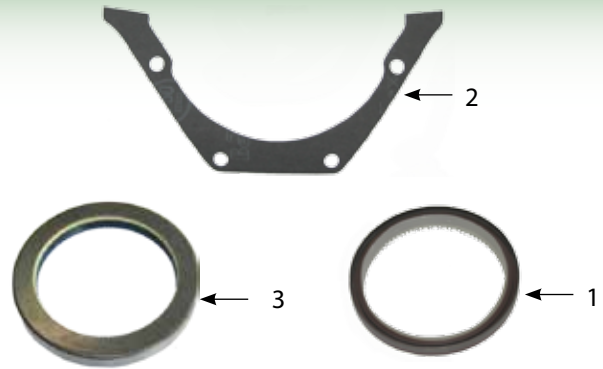

- 1. **7554** Crankshaft Lip Seal Fiat 80-90 110-90 110-90 114 x 135 x 13 Rear
- 2. **7555** Crankshaft Gasket Fiat 110 - 90 110 - 90
- 3. **7037** Seal Fiat 80-90 70-90 35 94 - 100 x 130 x 16

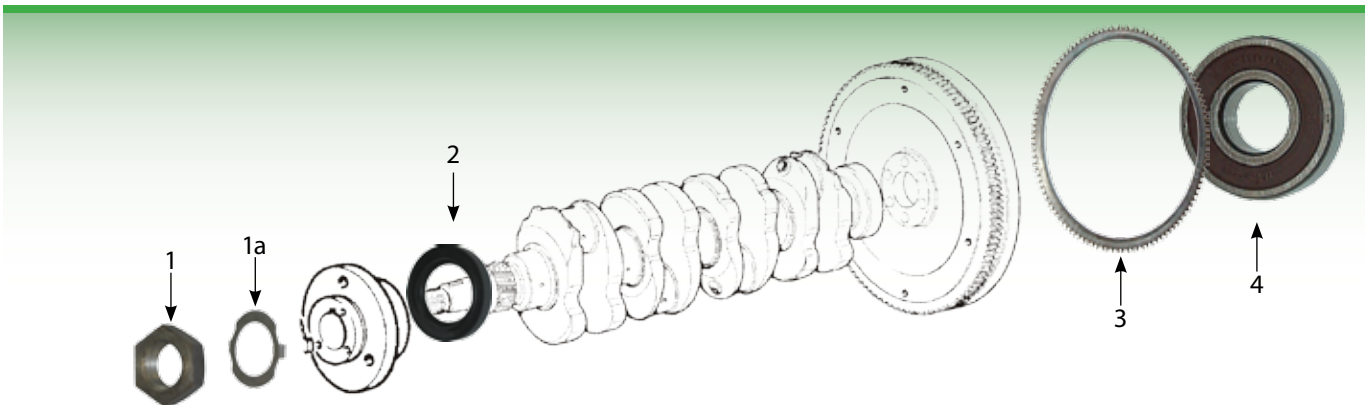

- 1. **7547** Fiat 80-90 Hub Nut
- 1a. **7546** 80-90/100-90 Tab Washer
- 2. **7113** Timing Cover Seal Fiat 100/140-90 Front
- 3. **7545** Ring Gear Fiat 80-90 110 Teeth
- 3. **7020** Ring Gear Fiat 100-90 110-90 - 127 Teeth
- 3. **7556** 110-90/110-90 C/S Ring
- 4. **62042RS** Spigot Shaft Bearing IHC 385 395 454 475 484

7801

Pulley Adaptor Front Crankshaft Fiat 110-90 Fiat 5 & 6 Cylinder



7127

Oil Pump Valve Gasket Fiat 100-90



42883

Oil Pump Ford 30 35 L TD TN TL Series Fiat 40 50 80 90 94 L Series



7573

Oil Pump Del.Pipe Gasket Fiat 90,115,130-90



- 1. **7543** Conrod Fiat 90 93 94 F & L - 38mm Pin
- 2. **7553** Conrod Bush Fiat 110-90
- 3. **7552** Conrod Bolt Fiat 110-90

Fuel Parts

7570



Leak Off Pipe Fiat

7580



Injector Pump Banjo Bolt
Fiat 100/90

Fuel Lift Pumps

7571

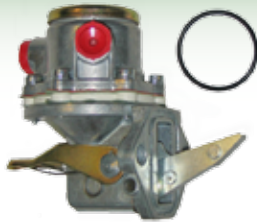

Fuel Lift Pump Fiat 55 to
80-90 480 - 780 L60-L95
JX60-JX95 3435 - 7635

7572



Fuel Lift Pump Fiat 110/90 F
series 680 - 880

1976



Solenoid 12v Diesel
Stop BOSCH



7119

Fuel Tank Fiat Reserve
90 100 110/90

7284



Fuel Sender Fiat
780-980DT-110/90

7757



Fuel Tank Fiat 100-90

7285



Fuel Tank Cap Fiat

7796



Drive Gear Bosch Injector Pump
Fiat 110/90

7795



Splined Sleeve For Bosch
Injector Pump 110/90

7806

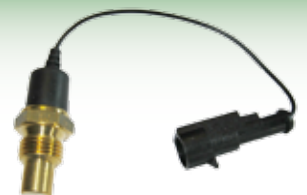

Sensor Temperature
Fiat TT TD

Fuel Parts

Throttle Parts

2666805

Heater Plug 35 4
Cylinder (thread
19.6mm)



7111

Reservoir
Tank Fiat



7086

Hand Throttle Fiat



7569

Injector Washer Fiat



Diesel Stop Solenoids

1976

12V
Solenoid Diesel
Stop Bosch



2038

Solenoid Diesel Stop
12V CAV 2 Spade
Connections



1992

Solenoid
Diesel Stop
12V CAV



7778

12V CAV
Solenoid Diesel Stop
Single Bolt
Connection



62727

Solenoid 12V Diesel
Stop 42s 54s Plug In
Type



7209

Throttle Cable Fiat 980



7207

Throttle
Cable Clip
Fiat



2304L

Throttle Cable Fiat 55 90 110 90
60 94 1.5 mtrs (nail head end)



7206

Hand Throttle
Lever Fiat



2304

Throttle Cable Fiat 55
90 - 110 90 - 60 94 -
940mm



100/90 Fuel Parts

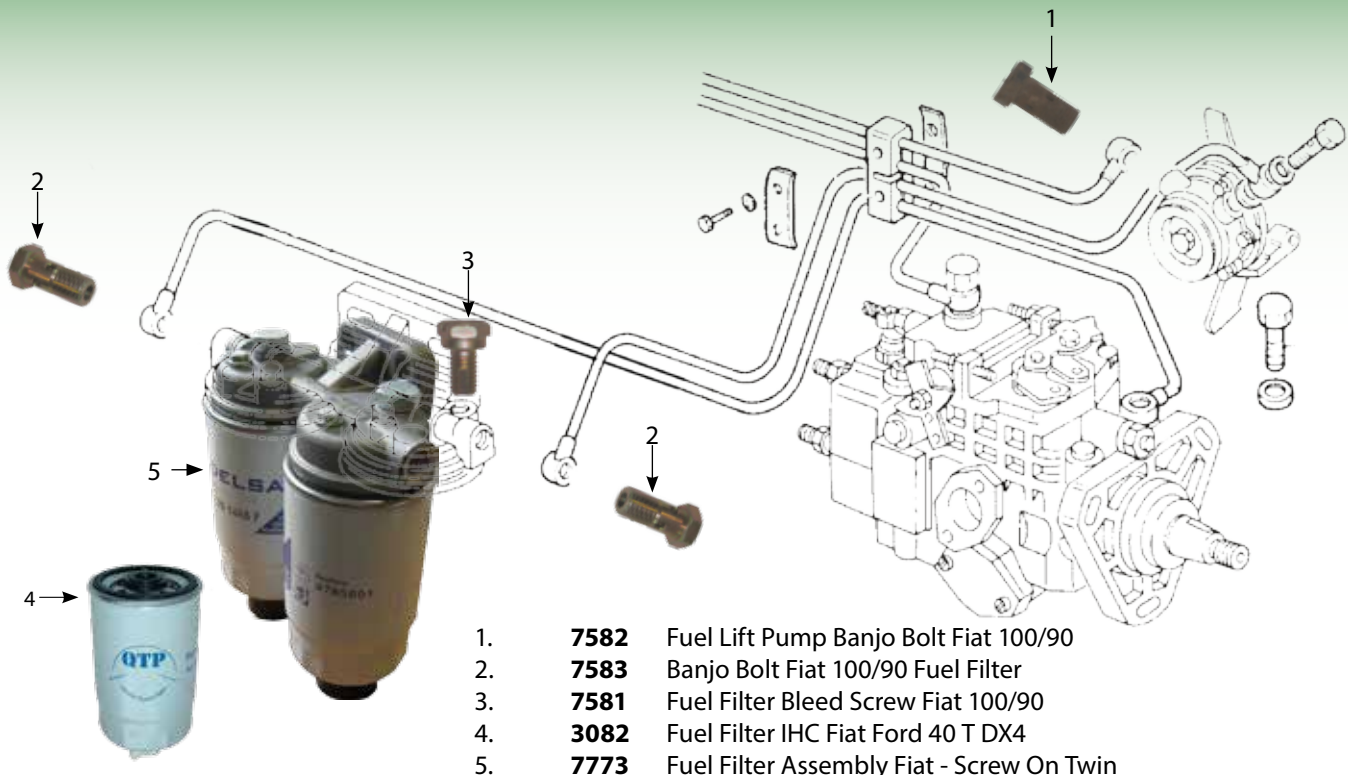

1. **7582** Fuel Lift Pump Banjo Bolt Fiat 100/90
2. **7583** Banjo Bolt Fiat 100/90 Fuel Filter
3. **7581** Fuel Filter Bleed Screw Fiat 100/90
4. **3082** Fuel Filter IHC Fiat Ford 40 T DX4
5. **7773** Fuel Filter Assembly Fiat - Screw On Twin

Exhausts

7357

Exhaust Clamp Fiat
Upper & Lower for
7350



7356

Exhaust Clamp Fiat
Upper & Lower for
7352



7350



Exhaust Fiat 82-94 580 680
780 880-4

7353

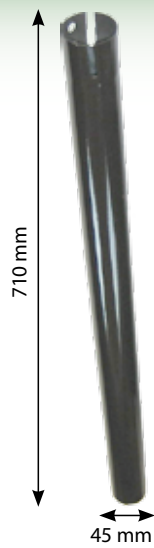

Exhaust Fiat Upper
Pipe for 7350

7352



Exhaust Fiat 880-5 90-90
100-90 110-90 115-90 F100
F110 F115 F120 & Pipe Com-
plete Incl Clamp

7354



Exhaust
Fiat
Upper
Pipe for
7352

Exhaust Manifolds

2



1.

7359

Exhaust Manifold Fiat 80-90 80-90DT

2.

7360

Exhaust Manifold Gasket Fiat 80-90

(Pack of 6)



7826

Exhaust Manifold Fiat
500 540 446 450 45-66
60-66 60-76 480 60-93
L60 New Holland 4010
5010 4030 TL65



4



1.

7364

Exhaust Manifold Fiat 100-90 100-90DT

2.

7365

Exhaust Manifold Coupling Fiat 100-90

3.

7360

Exhaust Manifold Gasket All Models Pack of 6



2

4.

3002

Nut M8 Metric Coarse Zinc & Yellow

5.

7590

Exhaust Manifold Stud Fiat

6.

7366

Exhaust Manifold Fiat 100-90 100-90DT



6

Cooling System

7313



Fanblade Fiat 110-90

F5143885



Radiator Fiat 580 680 780 980
60-90 70-90
80-90 90-90 100-90 110-90

7786

Expansion Tank Fiat
90



1. **7531** Plug Fiat
2. **7131** Crankshaft Plug Fiat
3. **7535** Sealing Washer Fiat 80-90



↑
1



↑
2



↑
3

Fanbelts

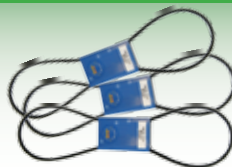

Part No	Models	OE Ref	Size
7310	Fan Belt Fiat 880	4712148	10 X 1275
7311	Fan Belt Fiat 55-90 60-90 80-90	4796650	10 X 1180
7312	Fan Belt Fiat 100-90 115-90 140-90 110-90 130-90 90-90	4796328	10 X 1140

Hoses Clips

Original Type



Part No	Diameter (""")	Diameter (mm)
50999	5/16" - 15/32"	8-12
50998	3/8" - 5/8"	10-16
50997	15/32" - 3/4"	12-20
50996	5/8" - 1"	16-25
50995	23/32" - 1"	18-26mm
50992	7/8" - 1 3/16"	23-36
50991	1 27/64" - 1 39/64"	36-41mm
50990	1 21/32" - 1 27/32"	42-47mm
59089	1 49/64" - 1 31/32"	45-50mm
50988	1 5/16" - 2 3/8"	40-60mm
50986	2 3/8" - 3 3/16"	60-80
50985	2 3/4" - 3 1/2"	70-90

Standard Type



Part No	Diameter (mm)	TYPE
2340SS	9.5-12	Stainless Steel
2345SS	11-15	Stainless Steel
2346SS	12-20	Stainless Steel
2357	16-25	
2357SS	16-22	Stainless Steel
2364SS	18 - 25	Stainless Steel
2394	23-35	
2394SS	25- 35	Stainless Steel
2396	28-48	
2397SS	30 40	Stainless Steel
2413SS	35-50	Stainless Steel
2426SS	45-60	Stainless Steel
2440	50-70	
2440SS	55-70	Stainless Steel
2441SS	60-80	Stainless Steel
2443	70-90	
2443SS	70-90	Stainless Steel

Small Hose Clips

Part No	Diameter (mm)
59659	11
59660	13
59658	14
59661	17



Heavy Duty Clamp

Part No	Diameter (mm)
51934	122 - 130
51933	113 - 121



Cooling System

7537



Hose Water Fiat 100-90
Bottom

5703



Water Pump Fiat 780



1. **7559** Thermostat Fiat 110-90 80-90 540 550 566 880
2. **7589** Thermostat Gasket Fiat 110-90
3. **7595** Thermostat Housing Fiat 100-90
4. **5711** Seal For Water Pump Tube 65.46 to 80.66
5. **5705** Water Pump Thermostat Housing Fiat
6. **7561** Water Pump Fiat 90/90-110/90 Bolt On Connect
7. **7557** Water Pump Gasket Fiat 110-90 110-90
8. **7331** Water Pump Gasket Fiat 90 Series
9. **7561P** Water Pump Fiat 90/90-110/90 Push In Connect Fiat 90's / TL / TN & New Holland 4635 - 6635
10. **7788** Connection Fiat 90 F's Water Pump - Push in
11. **7802** O Ring To Suit 7788
12. **7803** O Ring To Suit 7788

Gaskets

2048

Gasket Kit David Brown 770 880 3 Cyl Complete

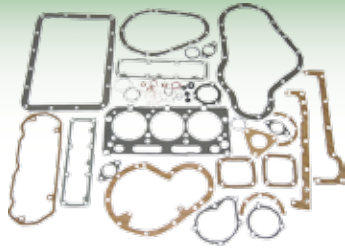

2054

Gasket Set David Brown Red 990 AD4 AD47

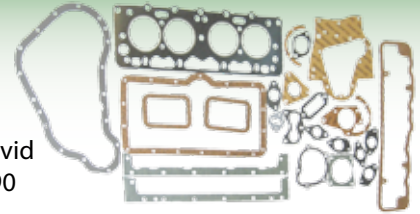

52638

Head Gasket David Brown White 950 880 4 Cyl



3376

Head Gasket Set David Brown Red 990

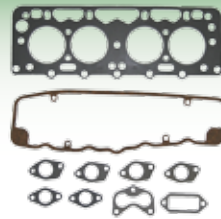

3714

Head Gasket Set David Brown 1594 1694 6 Cyl

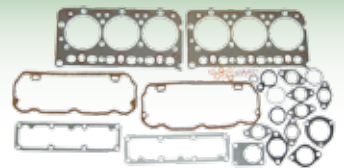

996/1210/1290/1394/1490/1410

3060

Head Gasket Set David Brown 990 - 1200

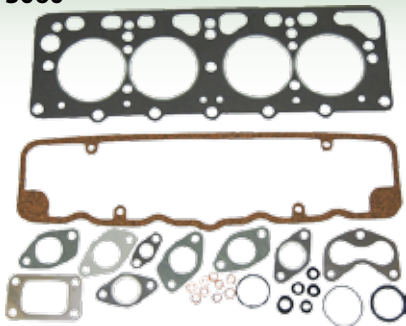

3378

Sump Gasket Set David Brown 990 1410



2053

Gasket Set David Brown 990 995 1200 1410 Complete

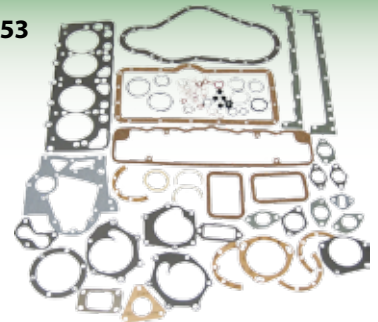

1166

Head Gasket David Brown 990 1210 990 995 996 1200 1210 1212 1290-1494

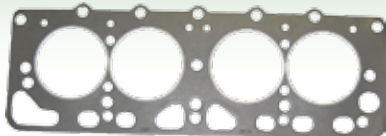

1167

Rocker Cover Gasket David Brown



1175

Timing Cover Gasket David Brown

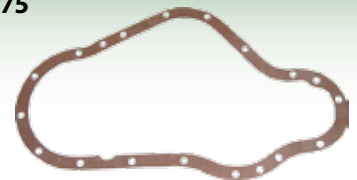

52119

Oil Seal Timing Cover David Brown 770 780 880 885 990 995 1190 1290 1390 1490 1690



52120

Crankshaft Seal Rear David Brown 770 990 1200 1690 1594 1694



Engine

Engine Components



Piston David Brown 995 996 1190 1194 1210 129 1394 1410 1412 1594 1690 1694



Ring Set David Brown 995 996 100.046mm Bore 1190 1200 1210 1290 1294 1390 1394 1490 1494 1594 1690 1694



Crankshaft Seal David Brown 995 996 Rear PAIR



Oil Filler Cap David Brown

Fuel Tank Cap

8002
Fuel Tank Cap Metal
100 Series David Brown

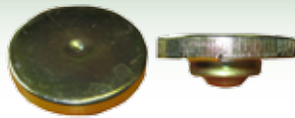

Fuel Filter Gauze

52619
Fuel Filter Gauze
David Brown



Fuel Lift Pumps

1143
Fuel Lift Pump David Brown
990 995 996 1200 - 1690
Fuel Filter Gauze=52619



52791
Fuel Pump
Case MX / MTX
MX100 MX110
MX120 MX135
MX150 MX170
MTX110 MTX120
MTX135



4970
Fuel Lift Pump David
Brown 3 Cylinder



Diesel Stop Solenoids

1976
Solenoid 12v
Diesel Stop
BOSCH



2038
Solenoid Diesel
Stop 12V
CAV 2 Spade
Connections



1992
Solenoid
Diesel Stop
12V CAV
Single Nut
Connection



7778
** USE 1992 ** Sole-
noid Diesel Stop 12V
CAV



62727
Solenoid 12V Diesel
Stop 42s 54s Plug In
Type



Fuel Senders

52068
Fuel Sender David Brown
990 995 996



52067
Fuel Sender David Brown
1490 1495 1594 1690



52069
Fuel Sender David Brown 1294 1394
1390 with Sekura Cab

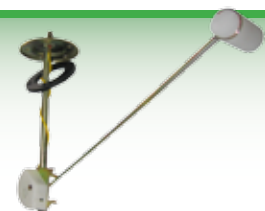

Cable End Clamps

51956

Cable End 1/4"
(6mm)



51957

Cable End
9/32" (7mm)



51959

Cable End
11/32" (9mm)



51958

Cable End Assortment
Pack of 25 1/4" x 3/8",
11/32" x 1/2", 9/32" x 1/2"



Pull to Stop Cables

52736

Stopper Knob David Brown
770 780 **Also 880 885 **



1829570

Stop Knob Red



1031

Thread Ø= 15 mm
Overall length =1560 mm
Outer cable=1270 mm



Stopper Cable Thread 10mm
Overall Length 1560m

1031R

Thread Ø= 9.70 mm
Overall length =1550 mm
Outer cable=1260 mm



Stopper Cable 1.5mtr -
Red Knob

4807

Thread Ø= 10 mm
Overall length =2220 mm
Outer cable=1920 mm



Stopper Cable Red T
Handle 7Ft / 2mtr

Rev Counter Cables

52719

Rev Counter Cable David
Brown 1190 1210 1212 1290
1390 1412 1490 1594 1690
880 885 990 995 996
1250mm 7/8" - 5/8"



52730

Rev Counter Cable David
Brown 880 990
1260mm 3/4" - 5/8"



52720

Rev Counter Cable David Brown
1190 1290 1390 1490 990 995
996
1440mm 7/8" - 5/8"

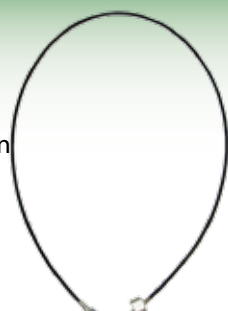



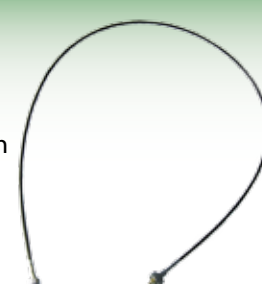

954959

Rev Counter Cable David Brown
995 996
1620mm
Small End 5/8" & Big End 7/8"

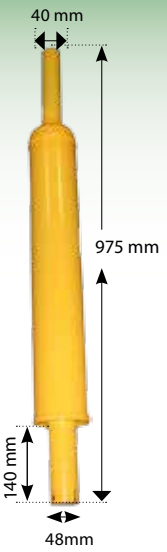
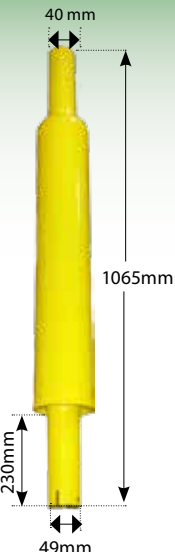
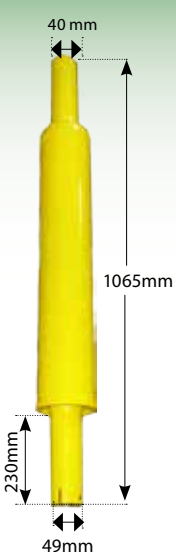

Exhausts

<p>1959E Exhaust David Brown 995 996 Case 580 Oval</p> 	<p>2109</p>  <p>Exhaust David Brown Round Box Black Fits 770 Late 880 885 995 1200</p>	<p>52656</p>  <p>Exhaust David Brown 1290 1294 1390 - 57mm OD **4 Cylinder** ** NOT for 1490 **</p>
<p>51648</p>  <p>Exhaust David Brown 770 780 Yellow Enamel 975mm 140mm 48mm</p> <p>Yellow Exhaust On Red Tractors</p>	<p>51645</p>  <p>Exhaust David Brown 880 3 Cylinder Yellow</p>	<p>51645C</p>  <p>Exhaust David Brown 880 3 Cylinder Yellow</p>
<p>51581</p>  <p>Exhaust David Brown 990 Selectamat- ic Early Red Enamel, Inner Diameter: 42mm</p>	<p>51644</p>  <p>Exhaust David Brown 990 Late Selectamatic RedRed Enamel, Inner Diameter: 48mm</p>	

Exhausts - Clamps - Caps

Weathercaps



51807 2" 51mm
51204 2 1/4" 56mm
51199 2 3/4" 70mm
51198 2 5/8" 66mm



62801 1 3/4" 45mm
59290 3 3/4" 100mm



3415 70mm 2 3/4"
3264 83mm 3 1/4"



61579 240 Rain Cap
3169 285 Rain Cap

51196 3 1/2" 89mm
51195 3 1/4" 82mm
51197 4" 101mm

Raincaps

Exhaust Clamps



Part no	Dimensions	Diameter
3066	38 mm	8mm
3283	41 mm	10mm
3067	45 mm	10mm
4137	51 mm	10mm
1327	54 mm	10mm
1326	57 mm	10mm
1633	64 mm	10mm
1637	66 mm	8mm
51203	70 mm	10mm
51201	80 mm	10mm
51202	92 mm	10mm

61481



5/16 Brass Nut

0826232



Exhaust Manifold Stud
 135 1 1/2" x 5/16" Also
 Elbow Stud

61482



3/8" Brass Nut

082075



Exhaust Manifold Stud
 1 21/32 x 3/8 UNF Also
 Elbow ** 62574 is Stud
 & Nut **

62298



Exhaust Manifold
 Stud Nut FE 35 3/8

62202



Nut Exhaust Manifold
 FE 35 3/8 Brass

Exhausts

52112
Exhaust Elbow
Exhaust Elbow
David Brown
41mm No
Notch
Gasket=52109

41mm

1900
Exhaust
Elbow David
Brown 990
995 47mm
Notch No
Notch Ver-
sion is 52112

47mm

53212
Exhaust Elbow
David Brown
770 780 880
885

194742
Exhaust
Elbow Gasket

52724
Exhaust
Manifold
David Brown
770 780 3
Cylinder
David Brown
880 885

52109
Exhaust Gasket David Brown 990

62298
Exhaust Manifold
Stud 3/8" UNC

62202
Exhaust Manifold
Stud 35 FE 3/8 UNC

53688
Gasket Exhaust Manifold
David Brown 990 995 996
1210 1290 1390 ** Suits
52738 **OE Ref: K907343

52118
Exhaust Gasket David Brown 990
1290 1490 Also fits 1294 1494

52738
Exhaust Manifold David Brown 4 Cyl-
inder 990 995 996 1210 1290 1390

52118
Exhaust Gasket David Brown
990 1290 1490

62298
Exhaust
Manifold Stud
3/8" UNC

62202
Stud Exhaust
Manifold 3/8" UNC

52178
Exhaust Manifold Elbow
David Brown 1594 Also
fits 1690 6 Cylinder

52118
Exhaust Gasket David
Brown 990 1290 1490

52705
Exhaust Manifold David
Brown 1594

52177
Flame Ring David Brown 1594 1690 6 Cylinder
Manifold Coupling

Cooling System - Hoses

780/880

52172



Hose Bottom
David Brown
780 770

1562



Hose David Brown 880 990
By Pass

52173



Radiator Hose Bottom
David Brown 880

53092



Air Hose Red Bonnet Im-
plematic 780 880

53091



Air Hose Manifold to Radiator
David Brown 780 880

53090



Air Hose Radiator to Cleaner
David Brown 780 880

990

1561



Hose Top David Brown 990
995 - 1390

4340



Hose Kit David Brown 990

995/996/1210/1212

1561



Hose Top David Brown
990/995-1390

2142



Hose David Brown 1200 995 996 Bottom

1290/1390

1561



Hose Top David Brown
990/995-1390

2140



Hose David Brown 1290 1390
Bottom

1410/1412

2141



Hose Radiator David Brown
1410 142 Top Syn.

Hoses Clips

Original Type



Part No	Diameter (""")	Diameter (mm)
50999	5/16" - 15/32"	8-12
50998	3/8" - 5/8"	10-16
50997	15/32" - 3/4"	12-20
50996	5/8" - 1"	16-25
50995	23/32" - 1"	18-26mm
50992	7/8" - 1 3/16"	23-36
50991	1 27/64" - 1 39/64"	36-41mm
50990	1 21/32" - 1 27/32"	42-47mm
59089	1 49/64" - 1 31/32"	45-50mm
50988	1 5/16" - 2 3/8"	40-60mm
50986	2 3/8" - 3 3/16"	60-80
50985	2 3/4" - 3 1/2"	70-90

Standard Type



Part No	Diameter (mm)	TYPE
2340SS	9.5-12	Stainless Steel
2345SS	11-15	Stainless Steel
2346SS	12-20	Stainless Steel
2357	16-25	
2357SS	16-22	Stainless Steel
2364SS	18 - 25	Stainless Steel
2394	23-35	
2394SS	25- 35	Stainless Steel
2396	28-48	
2397SS	30 40	Stainless Steel
2413SS	35-50	Stainless Steel
2426SS	45-60	Stainless Steel
2440	50-70	
2440SS	55-70	Stainless Steel
2441SS	60-80	Stainless Steel
2443	70-90	
2443SS	70-90	Stainless Steel

Small Hose Clips

Part No	Diameter (mm)
59659	11
59660	13
59658	14
59661	17





Heavy Duty Clamp

Part No	Diameter (mm)
51934	122 - 130
51933	113 - 121



Engine

Cooling System

Part No	Models	OE Ref	Size
3475	Fan Belt David Brown 990/1410 	K68073	10 X 1175
52176	Fan Belt David Brown 3 Cylinder 	K912196	10 x 1090

2485666



Thermostat 82| All Models

2083



Radiator Cap

1851095



Radiator Tap

Radiators

52767



Radiator David Brown
780 880

52125



Radiator David Brown 996 1210 1212
990 995 995 G 995 Q 995 SK

52164



Radiator David Brown
990 880 Early Red
4 Cylinder

52664



Radiator David Brown
1290 1390 1294 394mm
x 445mm 3 Row

Engine

Water Pumps

3789

Water Pump David Brown
995 996 4 Cylinder 1210 1212
1410 1412 990 995 996 Also
580F

Gasket=4832



4832

Water Pump Gasket
David Brown 995 996



1189

Water Pump David Brown
880 770 780 880 885



3833

Water Pump David
Brown 885 New Type



3791P

Water Pump David Brown 990
c/w Pulley 1200 1210 1212 990
990 Selectamatic 995 996



3853

Water Pump David Brown 990
New Type & 1490 1394 4 Cylinder



Water Pumps

3816

Water Pump David Brown
94's 6 Cylinder



3838

Water Pump David
Brown 1690



53139

Water Pump David Brown
Cropmaster 25 25D 30C 30D
900H



53140

Water Pump David
Brown 1490 1494 1690



53141

Water Pump David
Brown 1190 1190E
1194



53142

Water Pump David Brown
885 QCab With Power



Gasket Sets

3031



Gasket Set Zetor
4712/4718 Complete

5324

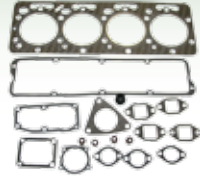

Head Gasket Set
Zetor 1.5mm 7520-
10520 7540-10540

3111



Sump Set Zetor
Crystal

5330

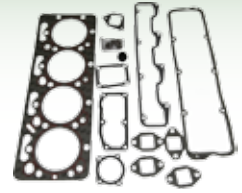

Head Gasket Set
1.2mm Zetor 7520-
10520 7540-10540

Individual Head Gaskets

5317



Head Gasket Zetor
1.2/110 9 Hole

1593



Head Gasket
Zetor 4712 4718
110mm

2359

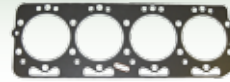

Head Gasket Zetor 4 Cylinder
8011/10011/10045/8145

5079



Gasket Zetor 8011
Centre Housing

Manifold Exhaust Gaskets

5047



Gasket Zetor

5048



Exhaust Manifold Gasket
Zetor

1339



Exhaust Manifold Gasket
Zetor

Sump Gasket

2360



Sump Gasket Zetor
5711-5748

Timing Sump Gasket

3035



Sump Gasket Zetor

Water Pump Gasket

3614



Water Pump Gasket Zetor

Timing Cover Seal

3040



Timing Cover Seal Zetor 8011

Crankshaft Oil Seal

3036



Crankshaft Oil Seal Zetor Crystal 6 Cylinder

5039



Crankshaft Pulley Zetor 8011 Front

Crankshaft Pulley

Engine Parts

7709



Engine Head With Valves Zetor UR1

7673



Cylinder Head with Plugs & Bushes Zetor 3320 - 5245 3 Cylinder

Oil Pumps

7688



Oil Pump Assembly Zetor UR1

7698



Oil Pump Assembly Zetor UR2

7702



Oil Pump Assembly Zetor UR2

Engine Parts

Piston Ring Kit



7196
Piston Ring & Liner Kit
Zetor 8011



7667
Cylinder Liner Kit Zetor Forterra 10641
Euro2 11441 Euro2 11741.4C Euro2
8641 Euro2 9641 Euro 2



7678
Cylinder Liner Kit
Zetor 2011 - 4011
2511 - 4511 5511 -
5647 5711 - 5748



7682
Cylinder Liner Kit
Zetor 100/3



7686
Cylinder Liner Kit Zetor
102/4



7689
Cylinder Liner Kit
Zetor 102/3



7666
Cylinder Liner Kit
Zetor Forterra UR3



7681
Cylinder Liner Kit Zetor
UR1 3320 3340 4340 4712
4718 5320 5340H



7674
Piston Kit Zetor 6211 5211
7211



7697
Cylinder Liner Kit
Zetor 7341 7711
7745

Fuel Components

Priming Pump

5016

Priming Pump Zetor
8011/8111



Fuel Lift Pumps

5124

Fuel Lift Pump
Zetor 5211



Fuel Tank Cap

2503

Fuel Tank Cap Zetor 6718
8011



5009

Fuel Lift Pump
Zetor 8011 8111



Diesel Stop Solenoids

1976



Solenoid 12v Diesel
Stop BOSCH

2038



Solenoid Diesel Stop
12V CAV 2 Spade
Connections

1992



Solenoid Diesel Stop
12V CAV Single Nut
Connection

7778



12V CAV
Solenoid Diesel Stop
Single Bolt
Connection

62727



12V Solenoid
Diesel Stop 42s 54s
Plug In Type

Fuel Pipes



7186
Glass Bowl Body
Zetor 5718-7045



2505
Fuel Bowl Filter
Zetor UR1 UR2
UR3



7187
Spring for Glass Bowl
Zetor 5718-7045



5004
Glass Bowl Zetor

7176







Fuel Pipe Zetor 5211-7745 from L/P to filters

7175





Fuel Pipe Zetor 5211-7745 from filter to Inj.
Pipe (Single Filter)

Exhausts

<p>7166</p>  <p>1460 mm</p> <p>50 mm</p> <p>Exhaust Zetor 6211-7245 - 2 Hook Type Enamel Type</p>	<p>7334</p>  <p>1460 mm</p> <p>50 mm</p> <p>Exhaust Zetor 6211 - 7245*Not Enamel*</p>	<p>1414</p>  <p>1270 mm</p> <p>50 mm</p> <p>Exhaust Zetor 8011 Ursus 385 Black</p>	<p>1889</p>  <p>1210 mm</p> <p>50 mm</p> <p>Exhaust Zetor Unified Black Swan</p>
---	---	---	--

<p>5030</p> <p>Exhaust Zetor 8111 8145 12111 12145</p>  <p>1180 mm</p>	<p>7696</p> <p>Exhaust Zetor 7711 - 7745T 3320 - 7340 7321 - 7341</p>  <p>1220 mm</p> <p>62 mm</p>	<p>7684</p> <p>Exhaust Silencer Zetor UR1 Enamel</p> 	<p>7685</p> <p>Exhaust Silencer Zetor 7001- 1421E Enamel</p> 
--	--	---	---

<p>1991</p>  <p>Air Intake Manifold Zetor 8011/8145</p>	<p>5180</p>  <p>Exhaust Gasket Zetor</p>	<p>Weather Caps</p>  <table border="1"> <tr> <td>3414</td> <td>57mm</td> <td>2 1/4"</td> </tr> <tr> <td>3415</td> <td>70mm</td> <td>2 3/4"</td> </tr> <tr> <td>3264</td> <td>82mm</td> <td>3 1/4"</td> </tr> </table>	3414	57mm	2 1/4"	3415	70mm	2 3/4"	3264	82mm	3 1/4"
3414	57mm	2 1/4"									
3415	70mm	2 3/4"									
3264	82mm	3 1/4"									

Hoses Clips

Original Type



Part No	Diameter (""")	Diameter (mm)
50999	5/16" - 15/32"	8-12
50998	3/8" - 5/8"	10-16
50997	15/32" - 3/4"	12-20
50996	5/8" - 1"	16-25
50995	23/32" - 1"	18-26mm
50992	7/8" - 1 3/16"	23-36
50991	1 27/64" - 1 39/64"	36-41mm
50990	1 21/32" - 1 27/32"	42-47mm
59089	1 49/64" - 1 31/32"	45-50mm
50988	1 5/16" - 2 3/8"	40-60mm
50986	2 3/8" - 3 3/16"	60-80
50985	2 3/4" - 3 1/2"	70-90

Standard Type



Part No	Diameter (mm)	TYPE
2340SS	9.5-12	Stainless Steel
2345SS	11-15	Stainless Steel
2346SS	12-20	Stainless Steel
2357	16-25	
2357SS	16-22	Stainless Steel
2364SS	18 - 25	Stainless Steel
2394	23-35	
2394SS	25- 35	Stainless Steel
2396	28-48	
2397SS	30 40	Stainless Steel
2413SS	35-50	Stainless Steel
2426SS	45-60	Stainless Steel
2440	50-70	
2440SS	55-70	Stainless Steel
2441SS	60-80	Stainless Steel
2443	70-90	
2443SS	70-90	Stainless Steel

Small Hose Clips

Part No	Diameter (mm)
59659	11
59660	13
59658	14
59661	17



Heavy Duty Clamp

Part No	Diameter (mm)
51934	122 - 130
51933	113 - 121



Cooling System Hose Radiator Bottom

<p>4209</p>  <p>Hose Radiator Zetor 8011 8045 - Straight</p>	<p>4208</p>  <p>Hose Zetor Crystal Bottom</p>	<p>4210</p>  <p>Hose Zetor Crystal</p>	<p>5326</p>  <p>Hose Bottom Zetor 2011 to 7745</p>
--	---	---	--

Hose Radiator Top

<p>4384</p> <p>Hose Radiator Zetor 8011 Top</p>	
--	---

Radiator Cap

<p>5029</p>  <p>Radiator Cap Zetor 8011</p>

Thermostat

<p>5107</p>  <p>Thermostat Zetor 8011</p>

			
Part No	Models	OE Ref	Size
2255	Fan Belt Zetor Crystal	98419479	13 X 1275
1237	Fan Belt Zetor 8111		10 X 1225
B45	Fan Belt Zetor - up to 6718	974312 974318	
59685	Fan Belt Zetor 10 x 1113 - V Belt		10 X 1113

Cooling System Water Pump & Gasket

5000

Water Pump Zetor 8011
Crystal 8011 8045



7179

Water Pump Gasket
Zetor 8011-8045

5001

Water Pump Zetor 8111
8111 8145 9111 9145
9211 9245 10111 10145
10211 10245



7178

Water Pump Gasket
Zetor 8111-10145

Water Pump

5164

Water Pump Zetor 6 Cylinder
Zetor 12011 12045



5163

Water Pump Unified Range - 2 Spout
5211 5245 6211 6245 7211 7245
7711 7745 4320 4340 6320 6340
7320 7340 4321 4341



5320

Water Pump Zetor Unified
- 1 Outlet 4911 5011 5911
5945 6011 6045 6911 6945
7011 7045



Water Pump Gaskets

7177

Water Pump Gasket Zetor
5011-7745



3614

Water Pump
Gasket Zetor



Water Pump Bearing

2506

Water Pump Seal Zetor



62032RS

Spigot Shaft Bearing Deutz



Renault Engines



59154

Engine Complete 4045D 350
Series Powertech Renault
Claas 55.5kW 75HP Ceres
55.5kw 75HP

RENAULT:

CERES 325 335
CELTIS 426
CERGOS 335



59152

Engine Complete 4045T High HP
350 Series 350 Series Powertech
Renault Claas 67kW 91HP
67kw 91HP

RENAULT:

ARES 547
CERES 355
CELTIS 446
CERGOS 355

Fuel Lift Pumps

780044

Fuel Lift Pump Renault 103-52
103-54 106-54 110-54 120-54
133-54 Renault 145-54 ** Off
Set Holes **



59520

Ares 550 620 630 640
Cergos 330 350



Fuel Injectors

51470R

Renault Ares
Celtis Cergos



Oil Pump

59252

Oil Pump John Deere 40s 50s
6000s 4 Cyl 5000s
4 Cyl 3200 3300 Renault



Viscous Fans

780201

Viscous Fan Renault Ares 540 546RX 560RX
566 616RZ 696 Celtis 426 456 Ergos 436 466
OE Ref: 7700042935



Water Pumps

59866



Water Pump John Deere 6010 6020 6030 Standard
Incl. 59860 Gasket & 59853 Seal** 7610 - 7810 Also
Renault Ares 540 - 610 - 725 - 826 Claas

Gasket = 59860

59859



Water Pump Repair Kit John Deere 10/20's
** Pump is 59866 **

780049



Water Pump Renault
MWM 4 & 6 cylinder
D226 D227 Fendt Case
IH 226.6 227.6 D227.4
D228.6 TD226.4.2 D225.4
D225.6

780173









Water Pump Renault
106-54 110-14 110-
54
120-14 120-54 133-
14 133-54 1151-4
1181-4 1181-4S 489
496

Diesel Stop Solenoids

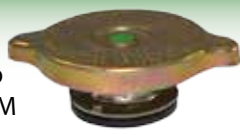
<p>1976</p>  <p>Solenoid 12v Diesel Stop BOSCH</p>	<p>2038</p>  <p>Solenoid Diesel Stop 12V CAV 2 Spade Connections</p>	<p>1992</p>  <p>Solenoid Diesel Stop 12V CAV Single Nut Connection</p>	<p>7778</p>  <p>** USE 1992 ** Solenoid Diesel Stop 12V CAV</p>	<p>62727</p>  <p>Solenoid 12V Diesel Stop 42s 54s Plug In Type</p>
--	--	--	---	--

<p>59388</p>  <p>Fuel Tank Cap Renault</p>	<p>59840</p>  <p>Fuel Tank Cap John Deere 00 10 20 Lockable JCB Fastrac Teleporter Case MX & MXM Series Massey 43 54 64 74 84 Series Claas Axion & Ce</p>	<p>59436</p>  <p>Fuel Tank Cap 00/10/20's No Lock</p>	<p>780015</p>  <p>Renault MWM Rear Crank Case Seal</p>
--	---	---	--

<p>780118</p>  <p>Renault Push Rod for MWM Engine</p>	<p>780119</p>  <p>Renault Ring Kit for MWN Eng</p>	<p>780016</p>  <p>Radiator Cap Renault MWM</p>
---	---	--

<p>780205</p>  <p>Radiator Renault 100 851</p>	<p>780206</p>  <p>Radiator Renault 100 891 951</p>	<p>780204</p>  <p>Radiator Renault 100 681 751 752 781 851</p>
--	--	--

Exhausts

<p>780096</p> <p>Exhaust Box Renault 145.14 145.54</p>	
---	--

Hoses Clips

Original Type



Part No	Diameter (""")	Diameter (mm)
50999	5/16" - 15/32"	8-12
50998	3/8" - 5/8"	10-16
50997	15/32" - 3/4"	12-20
50996	5/8" - 1"	16-25
50995	23/32" - 1"	18-26mm
50992	7/8" - 1 3/16"	23-36
50991	1 27/64" - 1 39/64"	36-41mm
50990	1 21/32" - 1 27/32"	42-47mm
59089	1 49/64" - 1 31/32"	45-50mm
50988	1 5/16" - 2 3/8"	40-60mm
50986	2 3/8" - 3 3/16"	60-80
50985	2 3/4" - 3 1/2"	70-90

Standard Type



Part No	Diameter (mm)	TYPE
2340SS	9.5-12	Stainless Steel
2345SS	11-15	Stainless Steel
2346SS	12-20	Stainless Steel
2357	16-25	
2357SS	16-22	Stainless Steel
2364SS	18 - 25	Stainless Steel
2394	23-35	
2394SS	25- 35	Stainless Steel
2396	28-48	
2397SS	30 40	Stainless Steel
2413SS	35-50	Stainless Steel
2426SS	45-60	Stainless Steel
2440	50-70	
2440SS	55-70	Stainless Steel
2441SS	60-80	Stainless Steel
2443	70-90	
2443SS	70-90	Stainless Steel

Small Hose Clips

Part No	Diameter (mm)
59659	11
59660	13
59658	14
59661	17



Heavy Duty Clamp

Part No	Diameter (mm)
51934	122 - 130
51933	113 - 121



Engine Parts 913 - 913

Gaskets

53170



Head Gasket Set Deutz
FL912 FL913 ** Head
Gasket is 53341 **

OE Ref: 02910048, 02928994,
02931476

53171



Gasket Set Deutz
FL912 4 Cylinder
** Head Gasket is
53341 **

OE Ref: 02910183, 02928974,
02929649, 02931313

53341



Head Gasket Deutz
FL912 FL913

OE Ref: 04157654

53338



Gasket Kit
Deutz 913

53172



Cylinder Kit Deutz
FL912 3 Ring

OE Ref: 02928882 029229790

59346



Cylinder Kit Deutz
4 Ring

OE Ref: 02928142 02929968

53337



Cylinder Kit
Deutz FL913 3
Ring 102mm

OE Ref: 04231513
04152191 04152185

53169

Cylinder Head
Deutz FL912 FL913

OE Ref: 04230613, 04230612
04236202,



53741

Rocker Cover Gasket Deutz
FL912 FL913 OE Ref: 03371692



Engine Parts 1013

53334



Gasket Set Deutz 1013
4 Cylinder

OE Ref: 2929666

53335



Cylinder Kit Deutz 1013

OE Ref: UH259101

53333



Gasket Set Deutz 1013
6 Cylinder

OE Ref: 2929665

Oil Pumps

51317



Oil Pump Deutz FL912 28mm
Suction pipe 26mm Hole
4 Cylinder DX3.10 - DX3.90
OE Ref: 04231307, 04158299
02130440

51318



Oil Pump Deutz 6 Cylinder
450/470/605/610 Also DX85
29mm Suction Pipe 31mm Hole
OE Ref: 4231309 / 2130385

51319



Oil Pump Deutz Turbo 6 Cylinder
36mm suction pipe 34mm hole
OE Ref: 4232511 / 4231306

53330



Oil Pump
Deutz 1013 4
Cylinder
OE Ref: 4289740

53329



Oil Pump Deutz
1013 6 Cylinder
OE Ref: 4289742

53326



Oil Pump Deutz
913
OE Ref: 4154886

Fuel Lift Pumps

1195

Fuel Lift Pump
Deutz D DX Intrac

OE Ref: 04157603, 2134511,
04230294, 04231021, 04230566



53360

Fuel Lift Pump Deutz Agrofam 100
85 & Ecoline 410T 410TB 420T 420TB
Agrotron K100 K100 Profiline K110
K110 Profiline K120 K120
OE Ref: 0011380830, 02111299,
02112559, 02112673, 02112754



53359

Fuel Lift Pump Deutz Agroplus 100
75 85 95 Agrotron 100 106 110 115
120 135 150 160 165 175 200 230 260
75 80 85 90 95 4.70 4.80 4.85
OE Ref: 02112672, 02113753, 04207013,
04503572, 04801613



Injector Pump



53328

Injector Pump
Deutz 1013

OE Ref: 2111335

Oil Pressure Switch



53736

Oil Pressure Switch Engine Deutz
All Models OE Ref: 01173414

Cooling

Water Pump

53331



Water Pump Deutz 1013
OE Ref: 4283173

53374



Water Pump Deutz Agrottron 108
118 128 130
OE Ref: 04258805

Viscous Fans



53616
Viscous Fan Deutz Agrottron 120 Profiline 130 Profiline
150 Profiline 165 Profiline 180 Profiline M600 M610
Profiline M620 Profiline



53617
Viscous Fan Deutz Agrottron M615 M625
M640 M650 610TTV 620TTV

Fan Belts



3492
Fan Belt Deutz DX610-110-85 10 X 1550

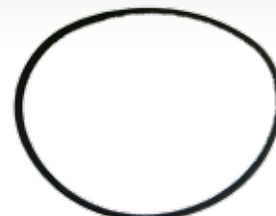

53373
Fan Belt Set Deutz DX6.05 DX6.06 DX6.07 DX6.08

Exhausts

53363

Exhaust Deutz DX110 110A
120 120A 85 85A 90 95A
DX6.10 DX6.30

OE Ref: 04306587

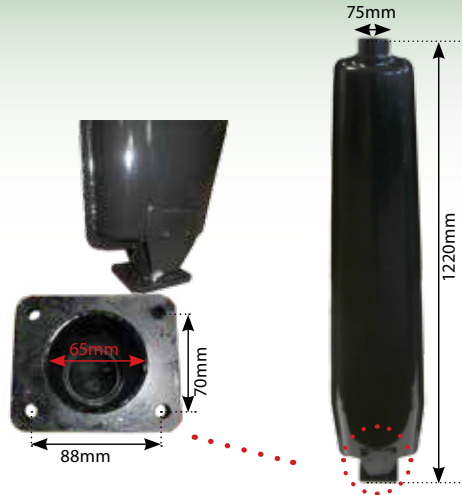

53354
Rain Cap 3"
(76.2mm) OD Gal-
vanised Steel

51931



Exhaust Elbow Deutz DX100
DX110 DX120

53361



Exhaust Manifold Deutz 4006
4006FS 4006U 4506 4506F
4506US 5006 5006F 5006U 5206
5206F 5206U

OE Ref: 02168675, 02242031

53362



Exhaust Manifold Deutz 5506 5506F
5506U 6006 6006F 6006U 6206 6206F
6206U 6806 6806F 6806U 7006 7006F
7006U 7206 7206A 7206F 7206U

OE Ref: 02168673, 02242032

53400



Exhaust Manifold Deutz D4005
D4505 D4006 D4506 D5006 D5206

OE Ref: 02242032

53398

Exhaust Elbow
Deutz D2506
D3006 D4006
D4506 D5006
D5206 D5506
D6006 D6206
D6806 D7006
D7206 D7506

OE Ref: 02382771



53399

Exhaust Elbow
Deutz D2807
D3607 D4007
D4507 D4807
D5207 D6007
D6207 D6507
D6807 D7007
D7207 D7807

OE Ref: 04338282



Cooling System

6343

Turbocharger Blizzard
4.236 Engine



6345

Radiator Cowl Blizzard



Exhaust Manifold

62541

Manifold Lower 165 212E



53206

Exhaust Elbow Landini 8830



Gaskets

3089

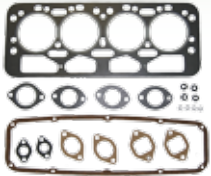

Head Gasket Set Leyland

53614



Seal Crankshaft Front Nuffield 10/42 10/60 3/42 3/45 3DL

3043



Sump Gasket Set Leyland 498

52639



Head Gasket P4 Nuffield - Copper

Liners

3053

Liner Leyland 100mm - 11mm lip



51546

Liner Leyland 4 Cyl Non Turbo



98mm

O Rings

51544

3.5mm

Engine O Ring Leyland

51545

5mm

Engine O Ring Leyland



Fuel Lift Pump

4258

Fuel Lift Pump Leyland JCB



Oil Pump

3366

Oil Pump Leyland 270 384 272 472 704282 482 802 804 4 Cylinder ONLY



Exhaust Parts

51774

Exhaust Pipe Nuffield 10/42 10/60 **4 Pinched Corners** 34mm ID

660 mm



51396V

Exhaust Leyland Vertical Enamel

1275 mm



3075

Exhaust Manifold Leyland 270 272 472 255 262 282 462 472



51778

Exhaust Manifold Flange Nuffield 10/42 10/60



1746

Exhaust Manifold Gasket Leyland to Cylinder H



1752

Exhaust Manifold Gasket Leyland

51847

Exhaust Manifold Nuffield 10/60 4/60 4/65



Cooling System

Radiator

51408



Radiator Leyland JCB 3C & Nuffield
Leyland 262 270 272 344 384 Nuffield
4/65 & JCB 3C

51306

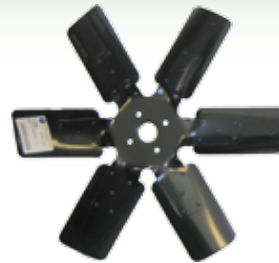

Fanblade - 16" Ley-Marshall
6 Blade

Fanbelt



Part No	Models	OE Ref	Size
2260	Fan Belt Leyland		13X1300

Water Pumps

3365



Water Pump Leyland
255 - 4100 Gasket in
the box

51416



Water Pump Leyland
BMC Nuffield 10/42
10/60 3/42 3/45 3DL
4/60 4/65 4DM

53136



Water Pump Leyland
Mini

53137



Water Pump Leyland
154

Valves

2194



Same Drago/Bufalo
Inlet Valve

2196



Same Drago/Bufalo Valve
Guide

2197



Exhaust Valve Guide Same
Drago/Bufalo

Exhaust

59506

Exhaust Same Silver 130 Corner Post Type Not for
Same Antares or Same Laser This is Heat Shield
Version

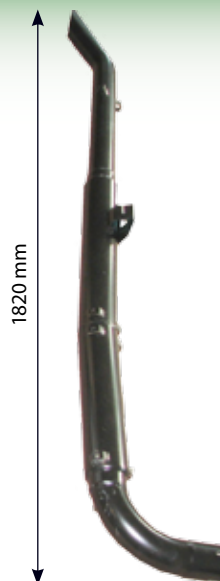

Fuel Lift Pump

4259

Fuel Lift Pump Same Laser Buffalo Panther Laser 90 100 130 Panther 90
Tiger 100 Taurus 60 Drago 120



Lift Pumps

4258



Fuel Lift Pump Leyland JCB

51566

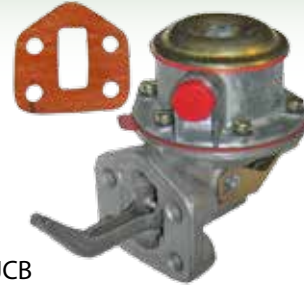

Fuel Lift Pump JCB
Fastrac Also fits Massey
Ferguson 4270

Ring Gear Industrial

0410264



Ring Gear Industrial 203 -
122 Teeth

52695



Exhaust Box JCB 408

Exhausts

Fuel Tank Caps

59840



Fuel Tank Cap John Deere 00 10 20 Lockable
JCB Fastrac Teleporter Case MX & MXM
Series Massey 43 54 64 74 84 Series Claas
Axion & Ce

59436



Fuel Tank Cap John Deere 00 10 20 No
Lock JCB Fastrac Telehandler Claas
Axion Celtis Massey 43 54 64 74 84 Series
Case MX & MXM

Exhausts

<p>3240A</p>  <p>1070 mm 55 mm</p> <p>Exhaust 165 188 Black Enamel Also 50B Clamp to Suit 1326 - White Aluminium is 62067</p>	<p>3238</p>  <p>1020 mm</p> <p>Exhaust 565 575 590 Black Enamel 265 290 Clamp to Suit 1326</p>	<p>6312</p>  <p>610 mm 55 mm</p> <p>Exhaust 50HX Modified End</p>
---	--	---

Exhaust Elbow Gasket

194742

Exhaust Elbow Gasket 165 168 (PACK 10)
188 265 Also Fits 275 290 390 690



Manifolds

<p>37781781</p>  <p>Exhaust Manifold 165 168 188 265 New Type Also fits 275 290</p>	<p>62541</p>  <p>Manifold Lower 165 212E *** ELBOW 53206 ***</p>
---	--

Manifold Gasket

36862134

Exhaust Manifold Gasket
212 236 248 165 168 188
265 275 Also Fits 290 390
565 575 590 690



Cooling

Hose Top

62250



Hose Top 50HXT
60HXT

Hose Bottom

62251



Hose Bottom 50HXT
60HXT

Various Models

Hose Top

52690



Hose Top Manitou - Various Models

52693



Hose Top Manitou - Various Models

Hose Bottom

52691



Hose Bottom
Manitou - Various
Models

52692



Hose Bottom Manitou -
Various Models

Fan Belt

62963



Fan Belt 50E 50EX 50HX Case 743
845 13 x 1325 856

2260



Fan Belt 240 Leyland - 13 X 1300
Massey Ferguson 50B

GASKETS



680009
Rocker Cover Gasket
Fendt 300 500 600
OE Ref: F385200210171



680011
Inlet Gasket Fendt 300s 500s
OE Ref: FT199204010040



680012
Head Gasket Fendt 300 500
OE Ref: F3852052210010

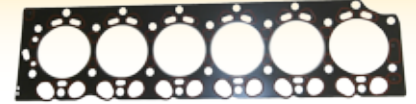

680072
Head Gasket Fendt 700
OE Ref: F716201210540



680014
Gasket Fendt For 916860061100 **
All T2 Models **
OE Ref: X820500051000



680015
Gasket Outlet Fendt 300s 500s 600s
OE Ref: F184230090071

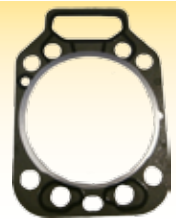

680018
Head Gasket Fendt 300 600 Early
OE Ref: FT138211210040



680019
Gasket Fendt Old 800s 900s
OE Ref: F824200100060



680036
Gasket For Turbo Fendt 718202090010
400 700 800 OE Ref: F716201100060



680064
Gasket Sump Fendt
OE Ref: F716201510130

FAN BELTS



	Part No.	Description	OE.
1	680042	Fan Belt Engine Rear Fendt 824 826	F836200040010
2	680043	Fan Belt Engine Front Fendt 824 826	F836200040020
3	680059	Fan Belt Engine Fendt 400 700 Later 800	F404200040020
4	680062	Fan Belt Engine Fendt 700 Early	F716200040020
5	680058	Fan Belt Air Con Fendt 700 800 AVX13X1040LA	X696624100000

STARTERS

53412
Starter Fendt 24V Mann Engine
4kW 11 Teeth LH Fit
OE Ref: F926900060041



Water Pumps

53375

Water Pump Valmet 6900 8000
8050 8050H 8150 8200 8400
Valtra



Viscous Fans

53618

Viscous Fan Valmet T120
T130 T140 T150 T160 T170
T180 T190
OE Ref: 836864264



Starters

52824

** USE 5146 **

Starter Valtra Val-
met 4.2kW Geared
605 6300 6400
800 8000 805 8100
8150 8450



5146

Starter Valtra (RH FIT)
00 05 55 6000 Series



Fuel Lift Pump

53131

Fuel Lift Pump Valmet Valtra Case CS

